

RESOL TT1

Mounting

Connection

Handling

Fault localization



48002690

Thanks for buying a RESOL product.
Read this manual carefully to get the best performance from this unit.

TT1

US/CA
manual

www.resol.de

Content

Safety regulations	2	3.3 Adjustment channel TO	7
Technical data and function survey	3	3.4 Adjustment channel TF.....	7
1. Sensor types.....	4	3.5 Adjustment channel DO.....	7
2. Installation.....	5	3.6 Adjustment channel DF.....	7
2.1 Mounting.....	5	3.7 Adjustment channel MM.....	7
2.2 Electrical connection.....	5	3.8 Status-LED Blinkcodes.....	7
3. Operating and function.....	6	4. Commissioning.....	8
3.1 Pushbuttons for adjustment.....	6	5. Tips for fault location	8
3.2 Adjustment / controll channels.....	6		

Safety regulations:

Please read the following information carefully before installing and operating the controller. In this way damage to the solar system by wrong installation will be avoided. Please observe that the mounting is adapted to the characteristics of the building, that the local regulations are respected and is conform with the technical rules.

Reprinting / copying

This mounting- and operation manual including all parts is copyrighted. Another use outside the copyright requires the approval of RESOL - Elektronische Regelungen GmbH. This especially applies for copies, translations, micro films and the storage into electronic systems.
Editor: RESOL - Elektronische Regelungen GmbH

Important notice:

We took a lot of care over the texts and drawings of this manual and to the best of our knowledge and consent. As faults can never be excluded, please note:
Your own calculations and plans under consideration of the current norms and DIN-directions should only be basis for your projects. We don't offer a guarantee for the completeness of the drawings and texts of this manual - they only represent some examples. They can only be used on own risk. No liability is assumed for incorrect, incomplete or false information and the resulting damages.

Errors an technical changes excepted.

Technical data

Housing: plastic, PC-ABS and PMMA

Protection type: IP 20 / DIN 40050

Size: 172 x 110 x 46 mm

Power supply: 115V~, 50-60 Hz

Output: 1 relais output, breaking capacity 4(1)A

Ambient temperature: 32 °F ... 104 °F

Display: LCD, multi-functional combined display with pictograms two 2-digit text fields and two 4-digit 7-segment displays as well as one 2-coloured LED

Mounting:
wall mounting, panel-mounting possible

Operation: by three pushbuttons

Input: 1 temperature sensor Pt 1000

Output: 1 standard relay (changeover)

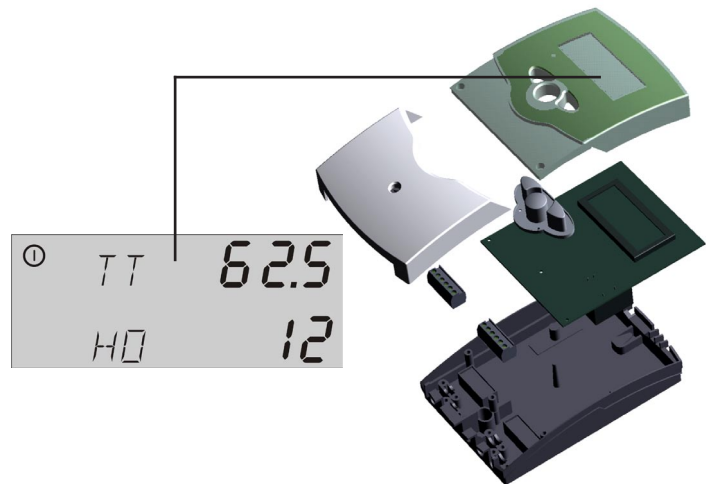

TT1

Electronic temperature controller (thermostat) with combined LCD display for indicating the current temperature and the setting parameters (menu guided)

A temperature sensor (PT1000 for example FKP6) from our catalogue is needed.

Operating mode

The RESOL thermostat compares the temperature measured by the temperature sensor with the adjusted switch-on temperature. When the current temperature drops below the the switch-on temperature the relais is switched ON. When the teperature is reached again the relay is switched OFF.

Depending on the adjusted switch-on and switch off temperature the controller is working in the heating or cooling mode. Depending on the application area all PT1000 sensors from our product catalogue can be used.

1. Sensor types

Precision-platin sensors type PT1000 (**FKP** and **FRP**) are used for TT1

The arrangement of the sensors is of great importance to the total efficiency of the regulator. The collector temperature should be measured in the upper part of the collector. In stores with integral heat exchanger, the sensor must be directly mounted in the upper part of the heat exchanger. When using external heat exchangers, the sensor must be fixed at the bottom of the store. For individual operation systems, our product range contains 3 different types of sensors (sensors for installation in existing immersion sleeves, flatscrew sensors or cylindrical clip-on sensors). The sensor types **FK** and **FR** have the same electrical features and are available in the same models, They only differ in the connecting cable:



FK... : collector sensor
FR... : reference sensor (store sensor)

FK: 1,5 m weather- and temperature resistant silicone cable for temperatures between -58 °F...+356 °F, mostly used for collectors.

FR: 2,5 m PVC cable for temperatures between 23 °F...170 °F, mostly used for stores.

Make sure that all electrical works are carried out according to the relevant local and IEE-regulations. The sensor cables carry low voltages and they must not run together in a cable conduit with cables carrying higher voltages than 50 Volts. When using longer cables or cable conduits, please use screened cables. The sensor cables can be lengthened up to 100 m, but the cross section must be 1,5 mm² (or 0,75 mm² up to a cable length of 50m); screened cables should be used preferably. The sensors must not be in direct contact with water, please always use immersion sleeves.

Immersion sensors: in different lengths (immersion depth) available

FK...60: 60 mm immersion depth, immersion sleeves of chromium-plated brass

FK...150: 150 mm immersion depth, immersion sleeve of chromium-plated copper

Important: The sensors must be completely pushed into the sleeve and the nut must be slightly tightened.

Cylindrical clip-on sensors: for any pipe diameter; cpl. with fastening collar; **FK...21** or **FR...21**

Ensure good thermal contact of the sensor with the pipe work by cleaning the contact area and by applying heat conduction paste between sensor and pipe. In order to protect the sensor cable against outside temperature influences, it is recommended to insulate the pipe.

Flatscrew sensors: for installation on flat surfaces
FK...9 or **FR...9**

Ensure good thermal contact. Use conduction paste and insulate the sensors against outside temperature influences.

Indication:

In order to avoid overvoltage damage at the collector (e.g. by lightning), it is highly recommended to use the overvoltage protection RESOL SP1.

2. Installation

2.1 Mounting

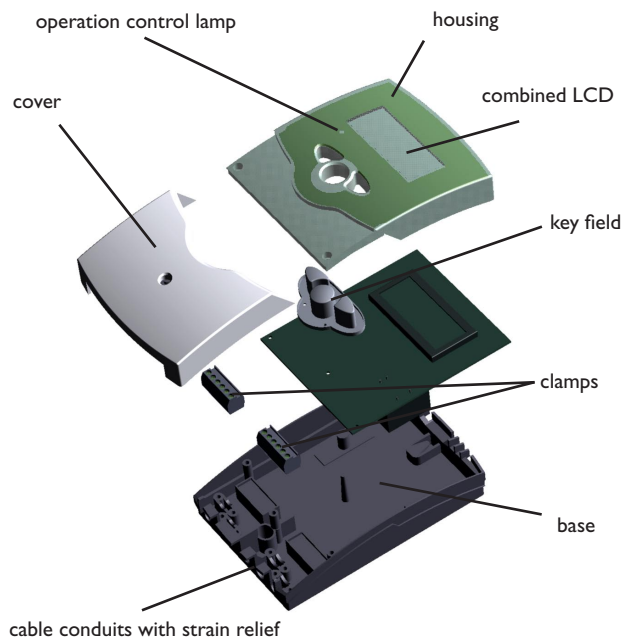

Warning!
Switch-off power supply before opening the housing.

The unit must only be located internally. It is not suitable for installation in hazardous locations and should not be sited near to any electromagnetic field. The controller must additionally be equipped with an all-polar gap of at least 3 mm or with a gap according to the valid installation regulations, e.g. LS-switches or fuses. Please pay attention to a separate laying of the cable lines and installation of ac power supply.

1. Unscrew the cross-recessed screw of the cover and remove it from the housing.
2. Mark the upper fastening point on the underground and pre-mount the enclosed dowel and screw.
3. Hang up the housing at the upper fastening point and mark the lower fastening point on the underground (hole pitch 130 mm), afterwards put the lower dowel.
4. Fasten the housing at the underground.

2.2 Electrical connection

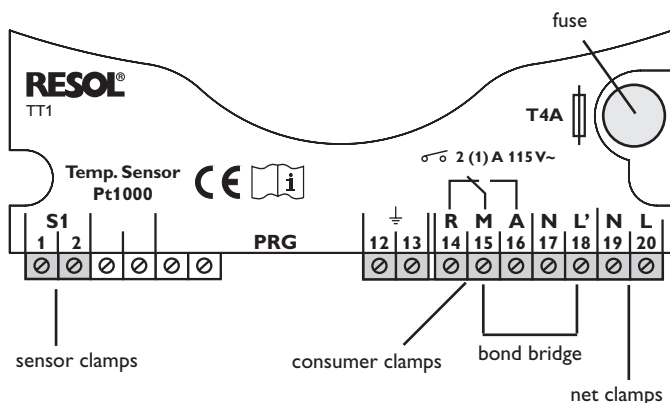

The power supply to the controller must only be made by an external power supply switch (last step of installation!) and the line voltage must be 115 Volt (50...60 Hz). Flexible lines are to be fixed at the housing by enclosed strain relief supports and screws.

The controller is equipped with 1 standard relay, to which the **consumer** can be connected:

- 14 = normally closed contact R
- 15 = middle contact M
- 16 = normally open contact A
- 13 = ground clamp \oplus

The **temperature sensors** (S1) will be connected to the following terminals independent of the polarity:

- 1/2 = sensor of heat source / heat sink

The **power supply** is effected to the clamps::

- 19 = neutral conductor N
- 20 = conductor L
- 12 = ground clamp \oplus

Notice:

The middle contact M (15) and the conductor L (18) are bridged from factory.

After removal of the bridge the changeover contact (RMA) becomes a potential-free relay.



3 Operation and function

3.1 Pushbuttons for adjustment

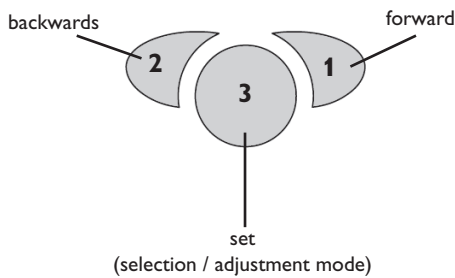
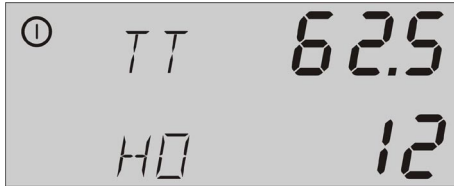

The controller is operated by 3 pushbuttons below the display. The forward-key (1) is used for scrolling forward through the indication menu or to increase the adjustment values. The backwards-key (2) is accordingly used for the reverse function.

The adjustment channels follow the pure indication channels in the display. In order to come to these channels, press the forward key to channel **HO** for 2 sec. If an **adjustment value** is shown on the display, **SEt** is indicated. In this case you can press the key „Set“ (3) in order to change into input mode.

- Select a channel by keys 1 and 2
- Shortly press key 3, so that „SEt“ flashes
- Adjust the value by keys 1 and 2
- Shortly press key 3, so that „SEt“ permanently appears, the adjusted value is now saved

3.2 Controller parameter / indication channels

- **TT**
Thermostat **T**emperature
- **HO**
Hours of **O**peration
- **TD**
Time **D**elay
- **TO**
Temperature **O**n
- **TF**
Temperature of **F**
- **DO**
Delay **O**n
- **DF**
Delay of **F**
- **MM**
Manual **M**ode
- **PG**
Pro**G**ramm
- **VN**
Version **N**umber

3.3 Adjustment channel TO

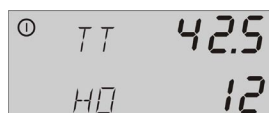

TO: Switch-on temperature
Adjustment range -4°F ... +302°F
Factory setting 104°F

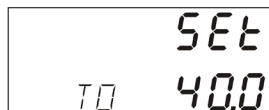

If the sensor temperature **TT** declines the adjusted switch-on temperature **TO** the controller switches the relays on. The symbol ① appears in the display and the status-LED is illuminated green.

The relays stay turned off during the adjusted switch on delay (**DO**) to avoid ineffective switching of the relays.

3.4 Adjustment channel TF



TF: Switch-off temperature
Adjustment range -4°F ... +302°F
Factory setting 113°F

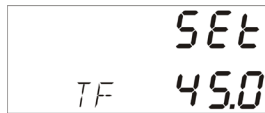

If the sensor temperature **TT** exceeds the in **TF** adjusted switch-off temperature the controller switches the relay off. The symbol disappears in the display and the status-LED is illuminated red.

The relais stays turned off during the adjusted switch off delay (**DF**) to avoid ineffective switching of the relay.

3.5 Adjustment channel DO

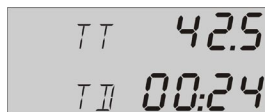

DO: Switch-on delay
Adjustment range
00:00...05:00 min
Factory setting 00:00 min



The relay is not switched on until the switch-on delay (**DO**) is expired to avoid ineffective switching on of the relay.

3.6 Adjustment channel DF



DF: Switch-off delay
Adjustment range
00:00...05:00 min
Factory setting 00:00 min



The relay is not switched off until the switch-off delay (**DF**) is expired to avoid ineffective switching off of the relay.

3.7 Adjustment channel MM

MM: Manual mode
Adjustment range 0, 1, 2
Factory setting 2 (Auto)



Manual mode	
0	= Off
1	= On
2	= Auto

In this channel the automatic or manual mode can be chosen. In the manual mode the relais can be switched on or off manually.

- 0 the relay is switched off permanently
- 1 the relay is switched on permanently
- 2 automatic mode

3.8 Status-LED Blinkcodes

- green: Relay/pump switched on
- red: Relay/pumpe switched off
- green/red blinking: Initialisation
- Sensor failure
- Manual mode

4. Commissioning



Ac power supply must be activated. The controller passes an initialisation phase in which the operating control lamp flashes red and green.

If individual conditions require an adaptation of the parameter, please adjust the values accordingly (vgl. 3.3).

5. Tips for fault location



Attention!
Before opening the housing please make sure that all poles are separated from the line voltage.

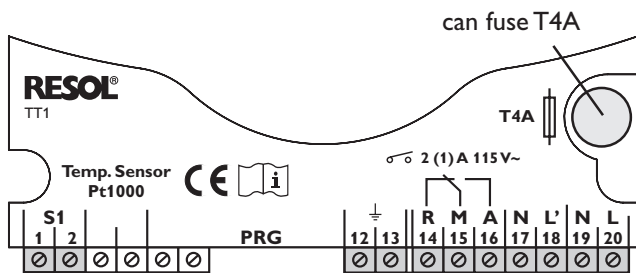

Please check the following points if the controller does not work faultlessly:

1. Power supply

If the operating control lamp is off, please check the power supply of the controller.

The controller is protected by one can fuse T4 A, which is situated at the base/isolation plate and can be replaced by opening the cover of the housing (spare fuse is enclosed in one of the accessory bags).

2. Sensor failure

If there is a malfunction due to a sensor defect, the operating control lamp flashes red and the symbol ⚡ is shown on the display. An error code for the concerned sensor is shown on the display.

Short-circuit: Short-circuit in the sensor wire with indication of the concerned temperature sensor (TT). The error code *-888.8* is shown on the display.

Line-break: Interruption of the sensor wire with indication of the concerned temperature sensor (TT). The error code *888.8* is shown on the display.

Clamped Pt1000-temperature sensors can be checked by a resistance-measuring device. The measured temperatures can be compared with the resistance values of the table opposite.

°C	Ω	°C	Ω
-10	961	55	1213
-5	980	60	1232
0	1000	65	1252
5	1019	70	1271
10	1039	75	1290
15	1058	80	1309
20	1078	85	1328
25	1097	90	1347
30	1117	95	1366
35	1136	100	1385
40	1155	105	1404
45	1175	110	1423
50	1194	115	1442

resistance values of PT1000 sensors

Your wholesaler:

Notes

Design and specifications are subject to change without notice. Illustrations may differ slightly from production models.