

RESOL DeltaSol® AX

Mounting

Connection

Operation

Application examples



reddot design award
winner 2005

DeltaSol® AX



manual

Thank you for buying a RESOL product.
Please read this manual carefully in order to put this controller to the best possible use.

www.resol.de



48002840

Contents

Imprint	2	2.3 Manual operation	5
Security devices	2	2.4 Maximum temperature limitation	6
Technical data and function survey	3	2.5 Anti-Freeze protection	6
1. Installation	4	2.6 Minimum temperature limitation	6
1.1 Mounting	4	2.7 Blinking codes	6
1.2 Electrical connection	4	3. Tips for fault diagnostics	7
2. Functions and Settings	5	4. Applications of use	7
2.1 Micro-switch and potentiometer	5	5. Annex: Fault diagnostics	10
2.2 Switch-on temperature difference	5		

Security advice

Please pay attention to the following security advice in order to avoid danger and damage to people and property.

Instructions

Attention should be paid

- to the statutory provisions for prevention of industrial accidents,
- to the statutory provisions for environmental protection,
- to the Health and Safety at Work Act 1974
- to Part P of the Building Regulations 2005
- to BS7671 Requirements for electrical installations and relevant safety regulations of DIN, EN, DVGW, TRGI, TRF and VDE.

This instruction is exclusively addressed to authorised skilled personnel.

- Only qualified electricians should carry out electrical works.
- Initial installation should be effected by named qualified personnel

Declaration of conformity

We, RESOL Elektronische Regelungen GmbH, D-45527 Hattingen, declare under our sole responsibility that our product *DeltaSol*® AX complies with the following standards:

EN 55 014-1

EN 60 730-1

According to the regulations of the above directives, the product is labelled with **CE**:

89/336/EWG

73/ 23/EWG

Hattingen, 07.07.2006

RESOL Elektronische Regelungen GmbH,

ppa. 

ppa. Gerald Neuse

Scope of delivery:

- controller *DeltaSol*® AX
(full kit incl. 2 temperature sensors)
- spare fuse under cover
- accessory bag consisting of silicone sealing, fastening screws and dowels, strain relief clamp and screws
- manual

Technical data**Housing:**

plug-in plastic PC-ABS

Protection type: IP 20 / DIN 40050**Ambient temp.:** 0 ... 40 °C**Size:** Ø130 mm, 45 mm height**Mounting:** wall mounting**Display:** 1 function control lamp**Inputs:** 2 sensor inputs PT1000**Outputs:** 1 standard relay (changeover contact)**Switch-on difference:** ΔT 2 ... 16 K adjustable**Switch-off difference:**

1,6 K below switch-on difference

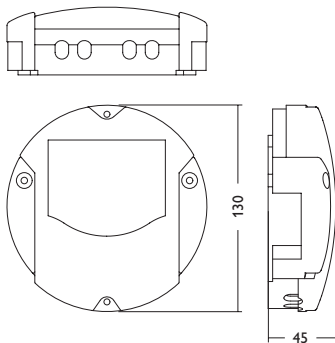
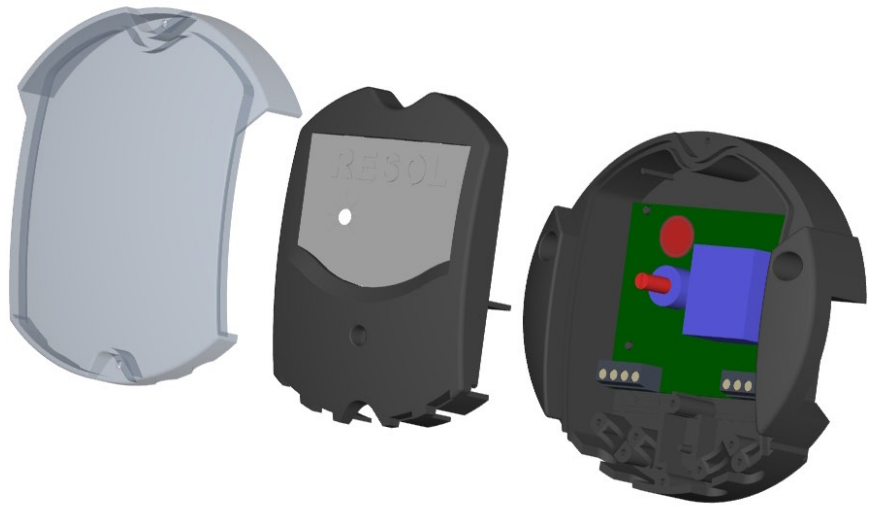
Control range: -20 ... +150 °C**Power consumption:** max. 4A**Powersupply:** 12V \equiv **DeltaSol® AX**

Thanks to its tough and deliberately simple design concept this low priced differential controller can be widely used in solar, heating and air conditioning systems. The large control range and adjustable temperature differences ensure that this unit can be used in almost all applications where switching processes are controlled by temperature difference.

The outer cover is available with an optional seal to protect the electronics against dripping water.

The controller checks a temperature difference ΔT measured by two temperature sensors by comparing this difference with a preadjusted switch-on difference (adjustable within the range of 2 ... 16 K). The control of the system is effected by a standard relay (= changeover contact), to which several motors or electrical valves can be connected. The controller switches- ON, if the adjusted temperature difference is exceeded; if this difference is underrun by 1,6 K, the controller switches-OFF.

Order indications

RESOL DeltaSol AX 115 211 70

RESOL DeltaSol A X- full kit - 115 211 80

incl. 2 temperature sensors Pt1000 (1 x FKP6, 1 x FRP6)

Accessory**Overvoltage protection**

It is highly recommended to connect the RESOL overvoltage protection SP1 to all collector sensors in order to avoid overvoltages (e.g. by lightning).

RESOL SP1 180 110 10



Electrostatic discharges can lead to damages of electronic components!



Dangerous voltage on contact!



1. Installation

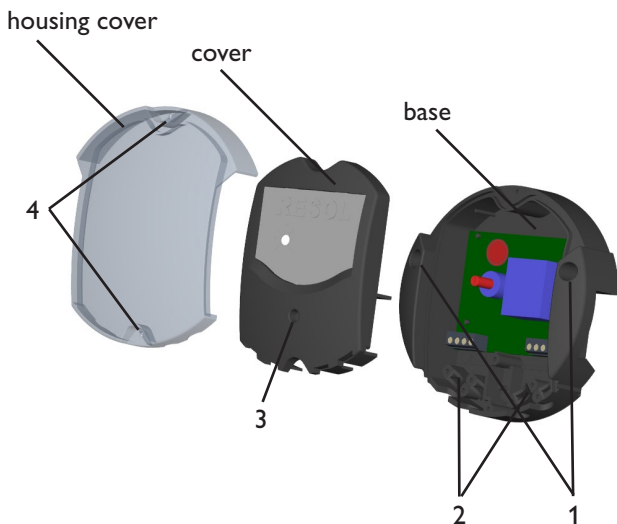

Warning!
Switch-off power supply before opening the housing.

The unit should be located internally. It is not suitable for installation in hazardous locations and should not be sited near to any electromagnetic field. Please ensure sensor cables and ac power supply are separated.

1. Choose a location, drill two holes of Ø6 mm side by side with a distance of 113 mm and fit in the enclosed dowels.
2. Fix the controller by means of the enclosed screws (4 x 40 mm)(pos. 1).
3. The electrical connection must be effected now. Power supply of the controller 12V_{DC} must be effected by external power switch.

1.2 Electrical connection

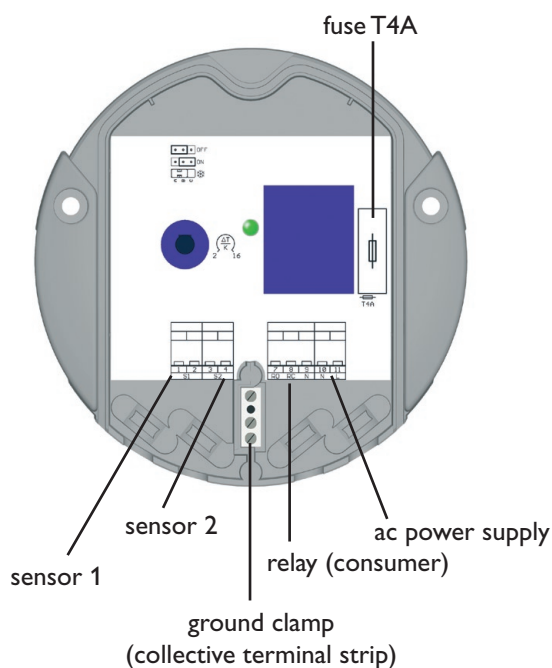

Connection of the sensors at the clamps:

- 1 / 2 = sensor 1 (e. g. collector sensor)
- 3 / 4 = sensor 2 (e. g. store sensor)

Connection of the consumer to the clamps:

- 7 = normally open contact relay (RO)
- 8 = break contact relay (RC)
- 9 = neutral contact relay (N)

ground clamp (collective terminal strip)

ac power supply to the clamps:

- 10 = neutral conductor N
- 11 = conductor L

ground clamp (collective terminal strip)

The guides of the required insertion channels must be broken away at the bottom side of the cover.

The cables are to be fixed to the housing by enclosed strain relief supports and screws (pos.2).

If necessary, activate anti-freeze function by jumper. If protection against dripping water is required insert the silicone sealing ring into the groove on the base plate taking care not to stretch it.

Put on the cover and screw it (pos. 3). If necessary, adjust temperature difference ΔT.

Put on housing cover and screw it (pos. 4).

Insert sealing band without strain into the nut

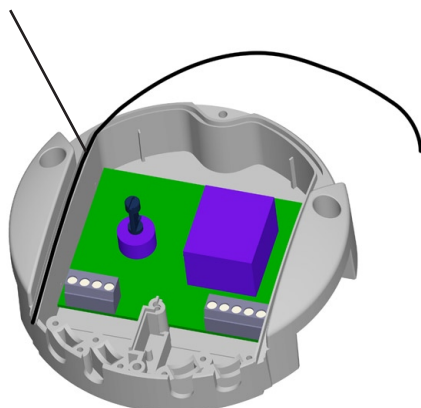

2. Functions and Settings

2.1 Micro-Switch and Potentiometer

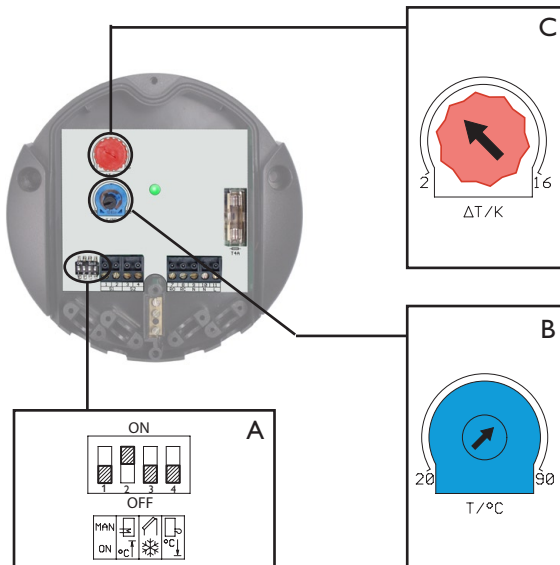

The micro-switch (A) activates (ON) deactivates (OFF) following functions:

- Manual operation (micro-switch 1)
- Maximum temperature limitation (micro-switch 2)
- Anti-freeze protection (micro-switch 3)
- Minimum temperature limitation (micro-switch 4)

Potentiometer (B) adjusts the temperature for the maximum or minimum temperature limitation in °C.

Potentiometer (C) adjusts the switch-on temperature in K

2.2 Switch-on temperature difference

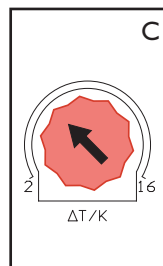

The controller checks the existing temperature difference between temperature sensor S1 and temperature sensor S2 with the adjusted temperature difference ΔT at the potentiometer (C). The controller switches over the relay as soon as the temperature reaches the adjusted nominal value, the operating control lamp flashes green. If the set value is underrun by a difference of 1,6 K (hysteresis, cannot be changed) the controller switches the relay back.

The factory setting for the switch-on temperature difference is preadjusted to 6 K. Adjustable temperature difference within a range of 2 ... 16 K.

2.3 Manual operation mode

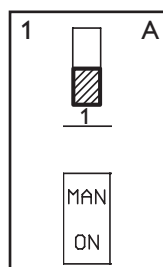

During commissioning and maintenance the relay can be switched-on permanently by manual operation.

The manual operation mode is activated and deactivated by the micro-switch. When the manual operation mode is activated, the operating control lamp flashes green.

The factory setting for the manual operation mode is deactivated (micro-switch in OFF-position), the controller is in automatic operation.

2.4 Maximum temperature limitation

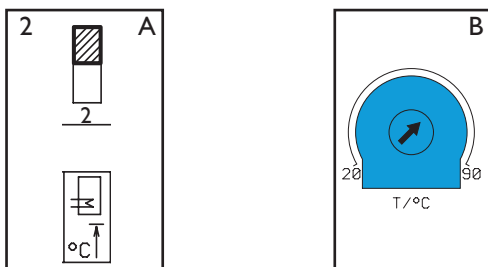

Micro-switch 2 activates the temperature limitation as a maximum temperature limitation. The temperature for the temperature sensor mounted on clamp S2 is adjusted as a limiting value at the potentiometer (B). If the adjusted maximum temperature is exceeded, the relay is switched over and so prevents e.g. a further storage charge (protection against overheating). If the maximum store temperature is exceeded, the operating control lamp flashes red.

The factory setting for the maximum temperature limitation is activated (micro-switch in ON-position), The temperature limitation is preadjusted to 60°C. Adjustable temperature difference within a range of 20 ... 90°C.

2.5 Anti-freeze protection

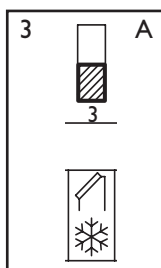

Micro-switch 3 activates an anti-freeze protection function. The anti-freeze protection function reacts to the temperature of sensor S1 (e.g. a collector sensor). As soon as this sensor measures a temperature below +4°C, warmer water is pumped from the store to the collector to prevent damages to the collector; in the course of this the operating control lamp flashes green. As soon as a temperature of +5°C is reached, the pump switches-off again.

Please note: As there is only a limited heat quantity of the store available for this function, the anti-freeze function should only be used in regions with few days of temperatures around freezing point.

The factory setting for the anti-freeze function is deactivated. (micro-switch in OFF-position).

2.6 Minimum temperature limitation

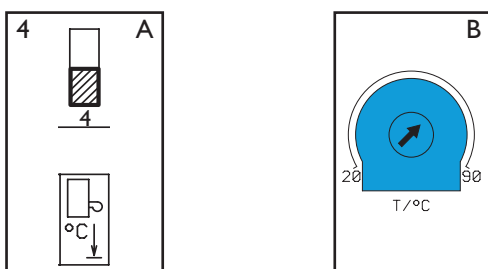

Micro-switch 4 activates the temperature limitation as a minimum temperature limitation. The temperature is adjusted as a limiting value for the sensor mounted on the terminals S1 at the potentiometer „temperature limitation“. The relay won't switch until the adjusted temperature is reached. This function should preferably be used in combination with a solid fuel boiler in order to avoid flue gas condensation within the boiler. By maintaining a minimum temperature limitation in the heat generator a flue gas condensation on the boiler walls is avoided. If the minimum temperature is underrun, the operating control lamp flashes red.

The factory setting for the minimum temperature limitation is deactivated (micro-switch in OFF-position). When activated, a temperature limitation of 60°C is preadjusted.

2.7 Blinking codes

Ready for use	red
Relay active	green
Manual mode active	green (blinking)
Maximum temperature exceeded	red (blinking)
Anti-freeze protection active	green (blinking)
Minimum temperature under-run	red (blinking)

The LED shows the actual operating status of the controller.

3. Tips for fault diagnostics

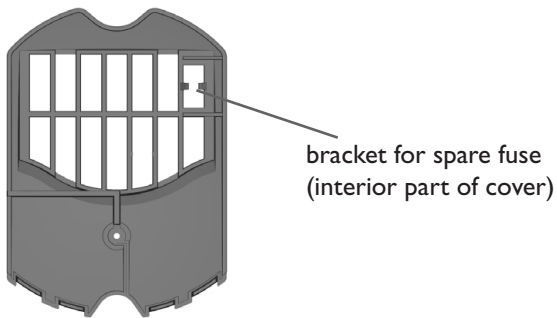

If the controller does not work perfectly, please check the following items:

If the controller does not switch on when there is a power supply available please check the fuses. The controller is protected by a fine fuse T4A, which can be replaced after having removed the housing and the cover. A spare fuse is enclosed on the backside of the cover.

Please check the sensors. Sensors which are not connected, must have following resistance values depending on the given temperature.

°C	-10	-5	0	5	10	15	20	25	30
Ω	961	980	1000	1019	1039	1058	1078	1097	1117

°C	35	40	45	50	55	60	65	70	75
Ω	1136	1155	1175	1194	1213	1232	1252	1271	1290

°C	80	85	90	95	100	105	110	115	
Ω	1309	1328	1347	1366	1385	1404	1423	1442	

Resistance values of the Pt1000-sensors

4. Application examples

Standard solar system with 1 store

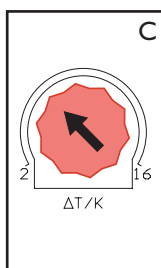
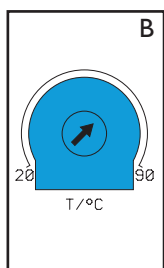
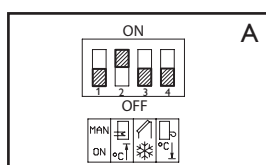

⊕ Use ground clamp collective terminal strip!

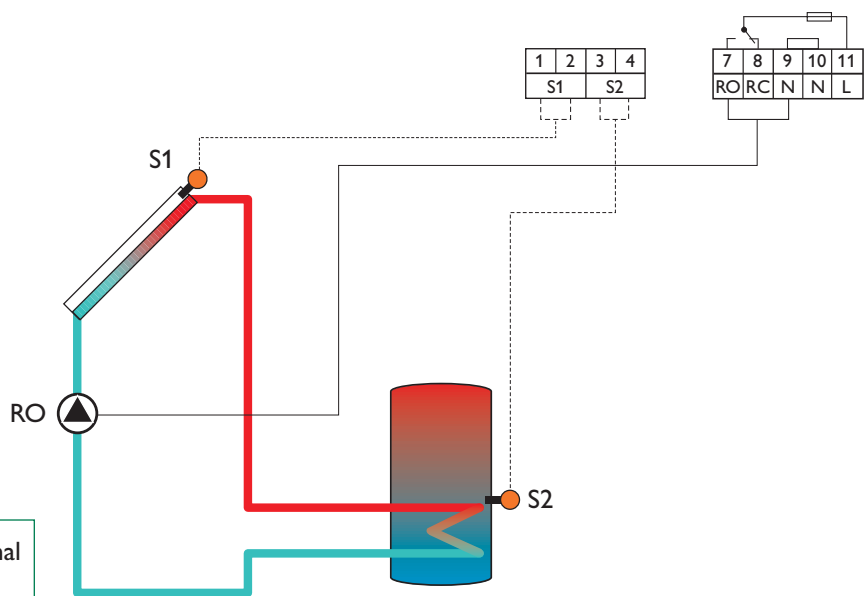

If the current temperature difference ΔT between collector sensor S1 and store sensor S2 exceeds the temperature difference adjusted at the controller, the solar pump is switched-on. Heat is transported from the collector to the store; in the course of this the temperature difference is reduced. If the adjusted temperature difference is underrun by a difference of 1,6 K (hysteresis, cannot be changed), the pump is switched-off again.

S1 = collector sensor

S2 = store sensor

RO = solar pump

Heating circuit - raising the return temperature

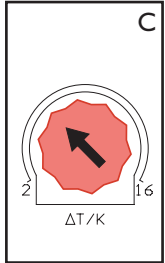
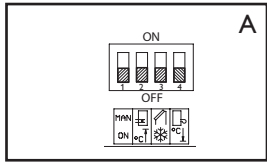

⊕ Use ground clamp collective terminal strip!

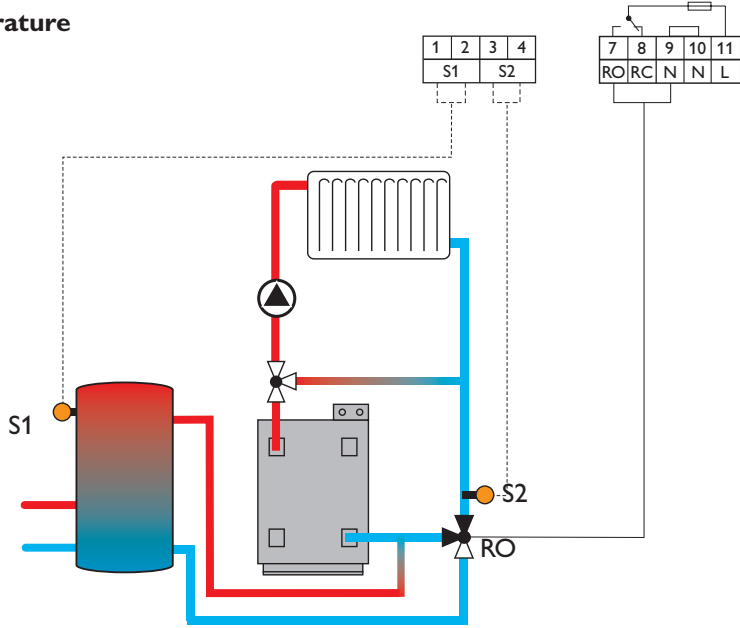

If the temperature difference ΔT between store sensor S1 and heating circuit return sensor S2 exceeds the temperature difference adjusted at the controller, the 3-way-valve is switched-over. The return temperature of the heating circuit is raised by the heat of the store so that less conventional energy is necessary to reach the required flow temperature; in the course of this the temperature difference is reduced.

If the adjusted temperature difference is underrun by a difference of 1,6 K (hysteresis, cannot be changed), the valve is switched to initial position.

- S1 = store sensor
- S2 = heating circuit reverse sensor
- RO = 3-way-valve

Heat exchange

(between two stores)

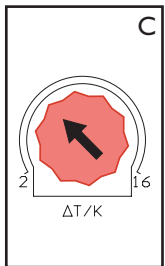
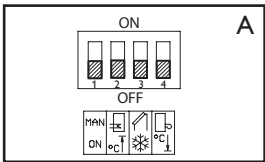

⊕ Use ground clamp collective terminal strip!

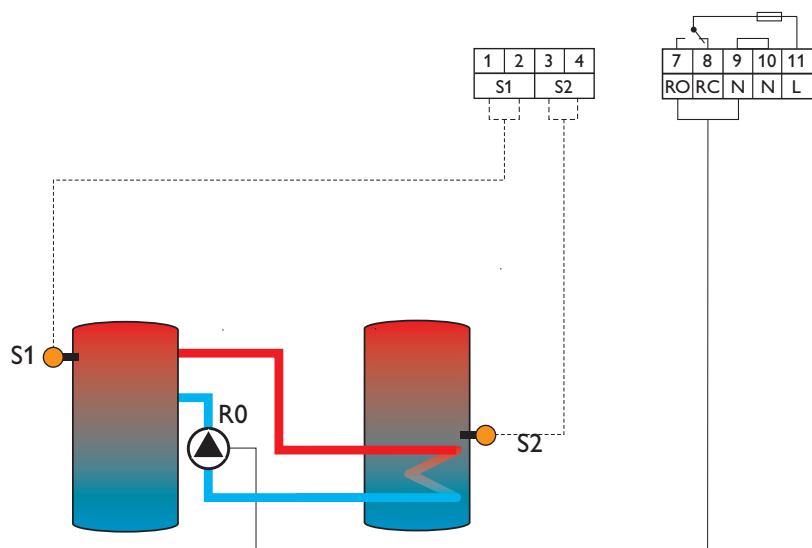

If the temperature difference ΔT between store (1)- sensor S1 and store (2)- sensor S2 exceeds the temperature adjusted at the controller, the circulation pump is switched-on. Heat is transported from the store (1) into store (2); in the course of this the temperature difference is reduced.

If the adjusted temperature difference is underrun by a difference of 1,6 K (hysteresis, cannot be changed), the pump is switched-off again.

- S1 = store (1) sensor
- S2 = store (2) sensor
- RO = circulation pump

Store charge

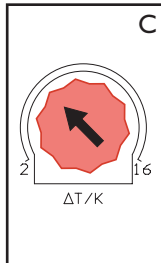
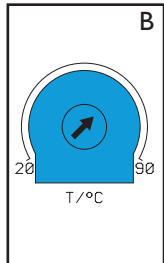
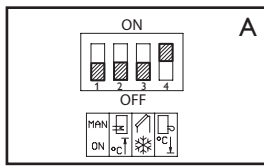

⊖ Use ground clamp collective terminal strip!

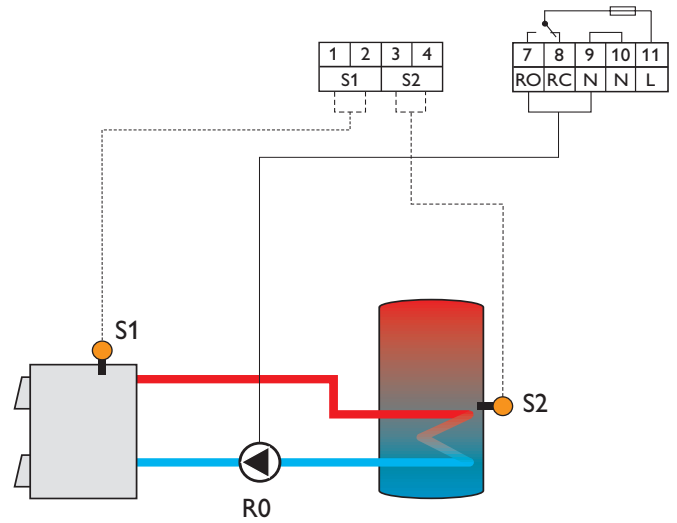

The controller compares the temperature at the sensor of the solid fuel boiler or boiler inserted in stove (S1) with the temperature at the sensor at store (S2). If the detected temperature difference is higher than or equals the preadjusted value ΔT , the pump (RO) is switched-on when simultaneously the given minimum temperature is reached or exceeded. The temperature difference is reduced.

If the difference 1,6 K (hysteresis, can difference is reduced, cannot be changed) underruns the adjusted temperature difference, the pump is switched-off again.

S1 = boiler sensor

S2 = store sensor

RO = circulation pump

5. Annex: Fault finding

Pump is overheated, but no heat transfer from collector to the store, feed flow and return flow are equally warm, perhaps also bubble in the lines.

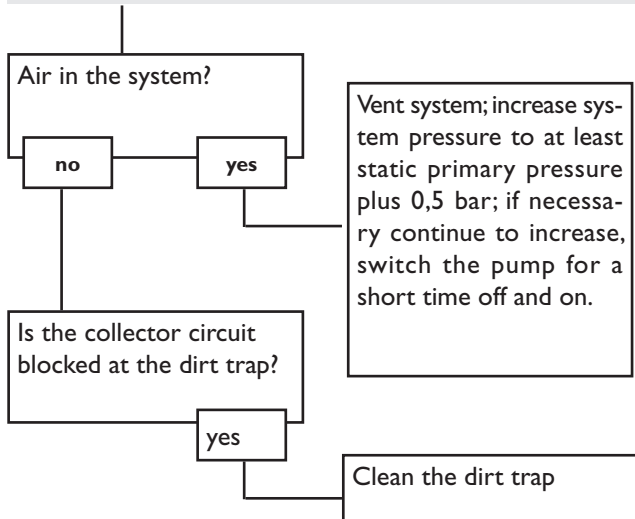

Pump starts for a short moment, switches-off, switches-on again, etc. („controller hunting“)

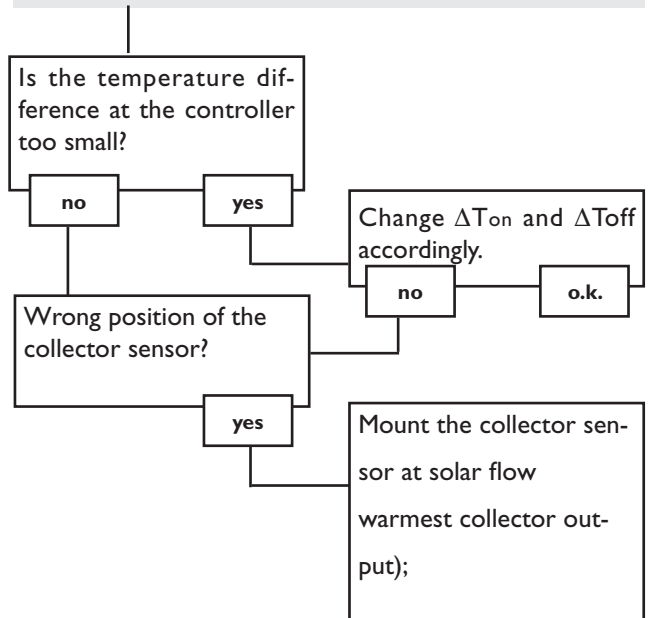

Pump starts up very late and soon stops working soon.

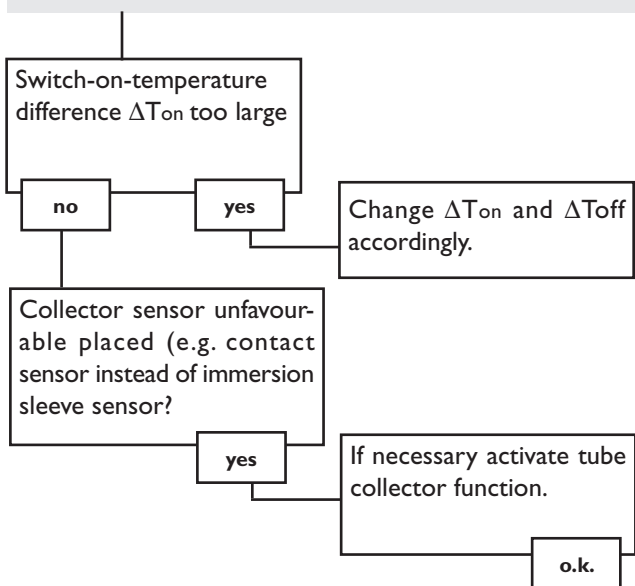

The temperature difference between store and collector increases enormously during operation; the collector circuit cannot dissipate the heat.

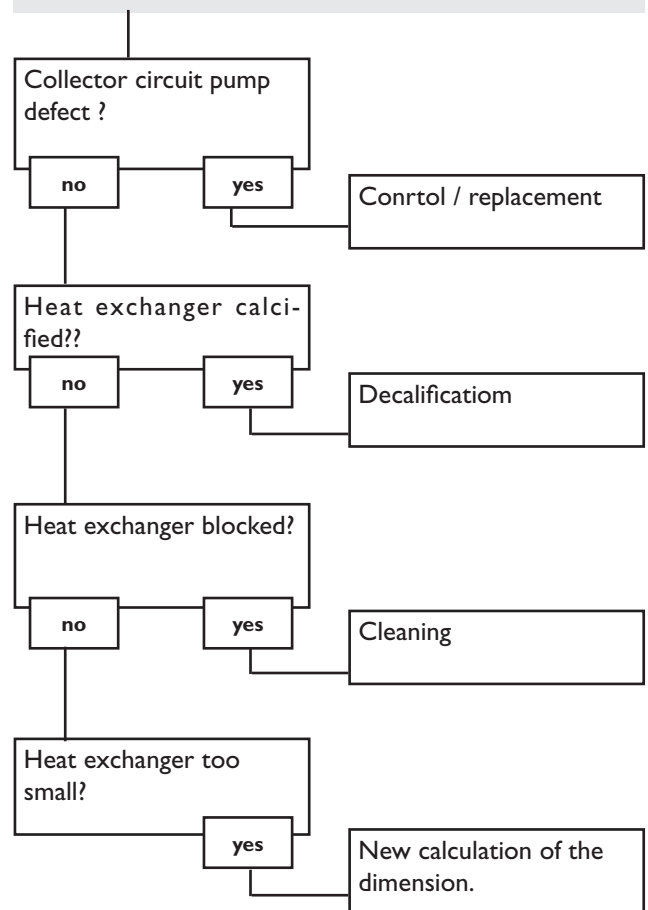

Stores are cooled during the night.

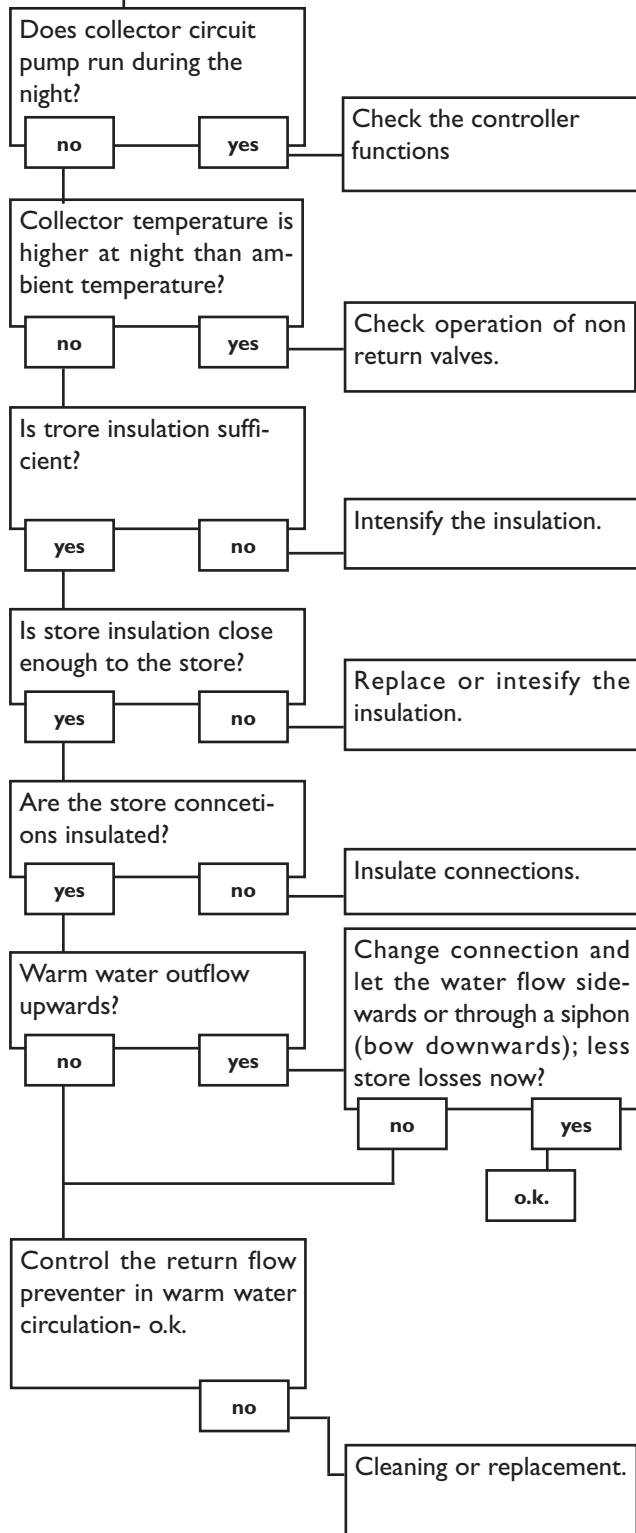

The solar circuit pump does not work although the collector is obviously warmer than the store.

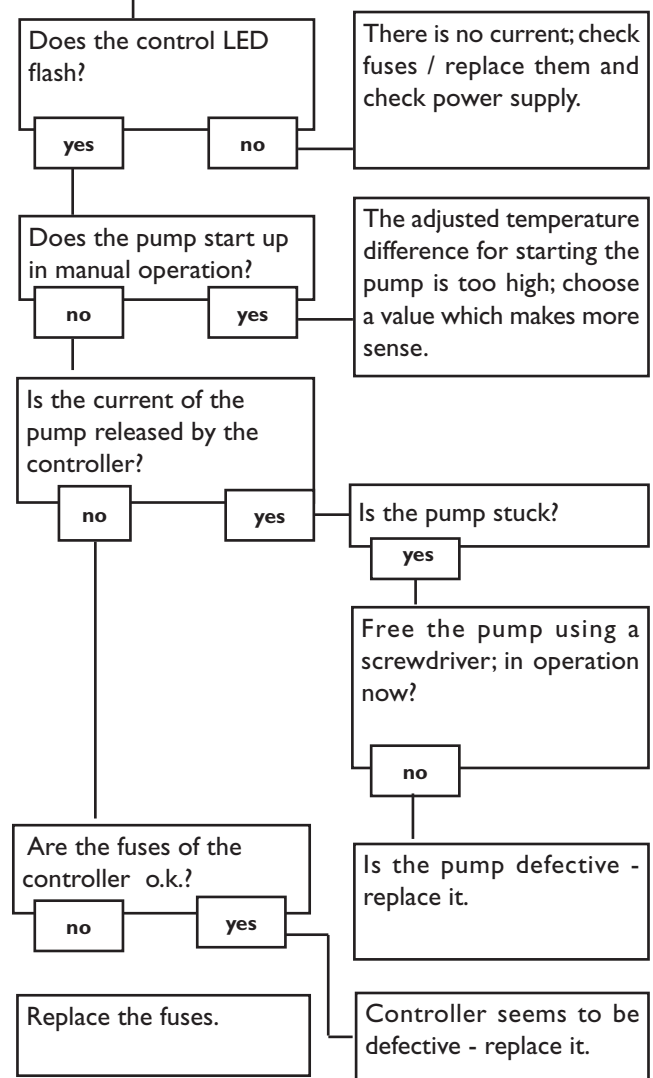

Notes

RESOL - Elektronische Regelungen GmbH

Heiskampstraße 10
D - 45527 Hattingen

Tel.: +49 (0) 23 24 / 96 48 - 0
Fax: +49 (0) 23 24 / 96 48 - 55

www.resol.de
info@resol.de

Distributed by:



Comments:

The design and the specifications can be changed without advance notice.
The illustrations can differ from the production model.