

RESOL WMZ

Mounting
Connection
Operation



WMZ



48006100

Thank you for buying this RESOL product.
Read this manual carefully to get the best performance from this unit

en-US/CA

Manual

www.resol.com

Safety advice:

Please read the following information carefully before installing and operating the controller. In this way damage to the solar system caused by wrong installation will be avoided. Please make sure that the mounting is adapted to the characteristics of the building, that the local regulations are respected and is conform with the technical rules. Please pay attention to the following safety advice in order to avoid danger and damage to people and property.

Instructions:

Attention should be paid to

- Valid national and local standards and regulations
- Respective valid standards and directives

Equipment to be installed and used in accordance with the rules of the National Electrical Code (NEC) or with Canadian Electrical Code (CEC), Part I. These instructions are exclusively addressed to authorized skilled personnel.

- Only qualified electricians should carry out installation and maintenance work.
- Initial installation should be carried out by qualified personnel

Subject to technical change. Errors excepted.

Table of contents

Safety advice 2

Technical data 3

1. Installation 5

 1.1 Mounting 5

 1.2 Electrical connection 5

 1.3 Flowmeter 5

2. Operation and function 6

 2.1 Push buttons for adjustment 6

 2.2 Graphic display 6

 2.3 LED flashing codes 6

3. Determining the ratio of the glycol-water mixture 7

4. Function 7

5. Indication and adjustment channels 8

 5.1 Heat quantity 8

 5.2 Flow and return temperatures 8

 5.3 Volumetric flow rate 8

 5.4 Power 8

 5.5 Antifreeze type 9

 5.6 Antifreeze 9

 5.7 Type of flowmeter 9

 5.8 Impulse Rate 9

 5.9 Subaddress 9

 5.10 Bus mode 10

 5.11 Bus master 10

 5.12 Sensor offset 10

 5.13 Reset 10

 5.14 Language 10

6. Examples of connection 11

 6.1 WMZ module in individual operation mode 11

 6.2 WMZ with controller 11

 6.3 Cascade without controller 11

 6.4 Cascade with controller 11

7. Troubleshooting 12

- yield control
- increase in efficiency
- graphic display
- power failure protection
- user-friendly through easy mounting
- easy-to-mount housing in outstanding design

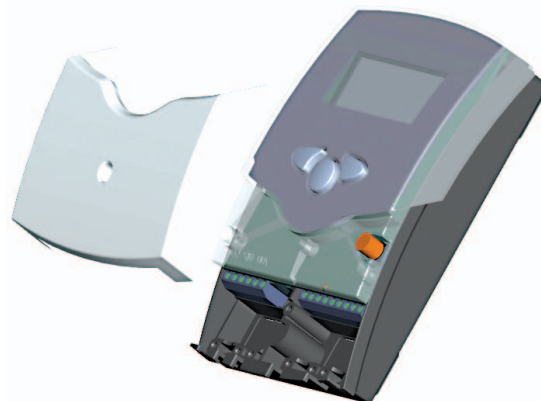

Included:

- 1 x WMZ
- 1 x accessory bag
 - 1 x spare fuse T1.25A
 - 2 x screw and wall plug
 - 4 x strain relief and screw
- Additionally included in the full kit:
 - 2 x sensor FRP45
 - 1 x flowmeter V40

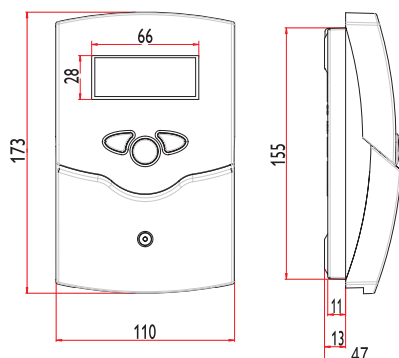

The RESOL WMZ is a universal calorimeter for thermal solar systems and conventional heating systems. This calorimeter especially takes into consideration that the density and the specific heat capacity of the heat transfer fluid depend on the temperature as well as on the mixing ratio of water/glycol. The calorimeter RESOL WMZ calculates the heat amount using these parameters, the measurement of flow and return temperature by 2 precision temperature sensors and the evaluation of the impulses of the flowmeter. A power failure protection guarantees that the adjusted system parameters and the calculated heat quantity are maintained in the case of power loss. By means of push buttons, different channels can be chosen and

user levels can be changed. In the first level, the temperature at the selected measuring points, the heat gained, the actual power or the volumetric flow rate of the system are indicated on the graphic display. A control lamp is also installed for indication of sensor defects and false sensors connections. A second level is used for displaying system adjustment values and control values, which can be analogously adapted to changes in the systems. The power supply is effected via a power supply plug. Additional RESOL modules can be connected to a bus connection. The VBus® connection enables the transmission of display values to a corresponding RESOL controller, PC or datalogger in order to be further processed or evaluated.

Technical data

Housing:

plastic, PC-ABS and PMMA

Protection type:

IP 20 / DIN EN 60529

Protection class: I

Ambient temp.:

32 ... 104 °F [0 ... 40 °C]

Dimensions:

6.8" × 4.3" × 1.9"

[172 × 110 × 46 mm]

Mounting: wall mounting, mounting into patch panels is possible

Display: Graphic display as well as bicolored LED

Operation:

3 push buttons in the front

Power supply: 115 V~

Power consumption: ca. 2 VA

Adjustment values:

- **Volume concentration of glycol:**

0 ... 70 % (1%-steps)

- **Pulse rate volumetric flow rate:**

0 ... 99 l/Imp (1 l/Imp - steps) for flowmeter RESOL V40

Temperature measurement:

with RESOL Pt1000 sensors only

Measurement precision: ± 0.3 K

Range of measurement:

-22 ... + 302 °F [-30 ... + 150 °C]

Bus: RESOL VBus®



Accessory

RESOL refractometer set

For determining the concentration of glycol in the heat transfer medium

280 009 60

VBus® board



Attention!

When the WMZ is connected to a controller, the VBus® master board has to be replaced with the VBus® slave board! When several WMZ are cascaded and connected to a data-logger or PC (see p. 10), only the VBus® master boards of the WMZs with the subaddress 1 or higher have to be replaced with the VBus® slave boards!



Electrostatic discharge can lead to damage of electronic components!

Warning

Switch off power supply and disconnect from power supply before opening the housing!

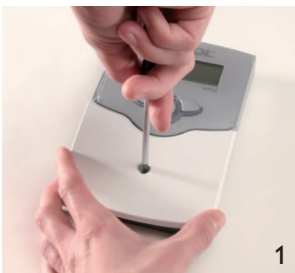

1

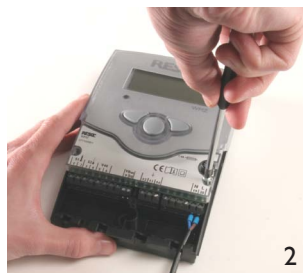

2

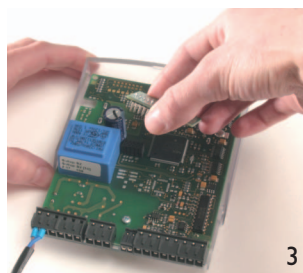

3

1. Unscrew the cross-head screw of the cover and remove the cover from the housing.
2. Unscrew the two lateral screws of the transparent shield and remove the shield.
3. Pull out the board which has to be replaced carefully. Replace with new board. Carry out assembly in reverse order.

1. Installation

1.1 Mounting

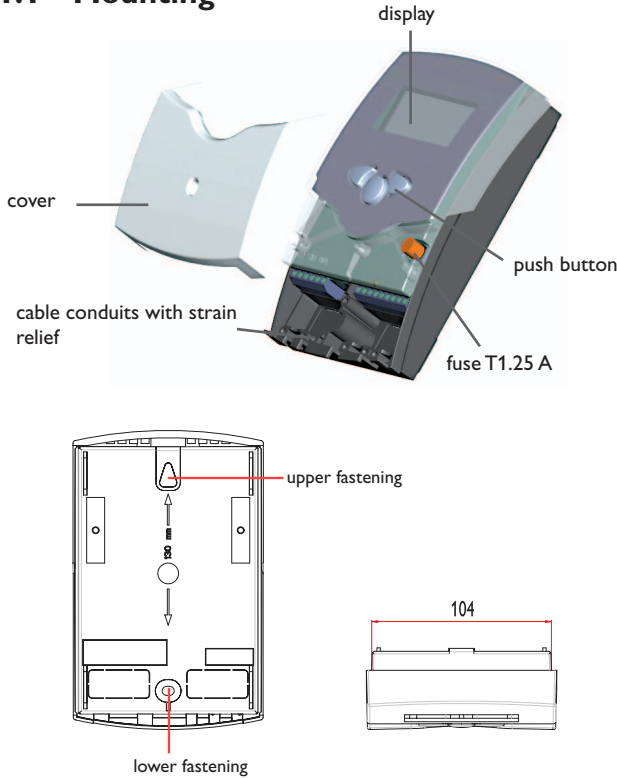

Warning!

Opening the housing will expose live parts!
 → Switch off power supply and disconnect the device from power supply before opening the housing!

The unit must only be installed

- in a dry interior location
- in a non-hazardous location
- away from electromagnetic fields

The controller must additionally be supplied from a doublepole switch with contact gap of at least 0.12" [3 mm].

Route sensor cables and power supply cables separately.

- Unscrew the cross-head screw from the cover and remove it along with the cover from the housing
- Mark the upper fastening point on the wall and drill
- Fasten the enclosed wall plug and screw leaving the head protruding
- Hang the housing from the upper fastening point and mark the lower fastening point through the hole in the terminal box (centers 5.1" [130 mm])
- Drill and insert the lower wall plug
- Fasten the housing to the wall with lower fastening screw and tighten
- Complete wiring connections in accordance with terminal allocations, see chap. 1.2 "Electrical connection"
- Place the cover back onto the housing
- Fasten the cover by means of the cross-head screw

1.2 Electrical connection

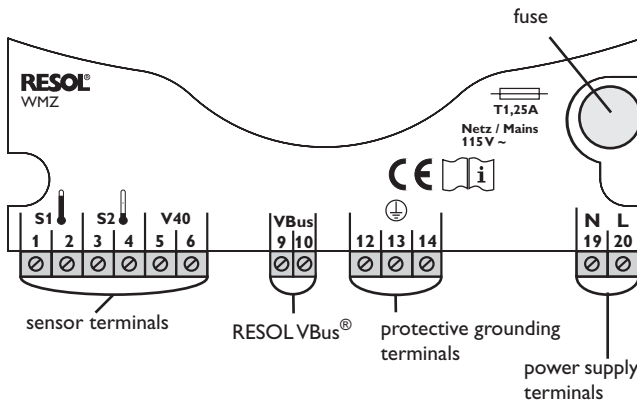

Electrostatic discharge can cause damage of electronic components



Warning: high-voltage components

The power supply of the controller must be carried out via an external power supply (last step!). The supply voltage must be 115 Volt (50 ... 60 Hz). Flexible cables are to be attached to the housing using the enclosed strain reliefs and the respective screws.

In order to use the RESOL WMZ along with a flowmeter RESOL V40, the following connection is to be carried out (polarity of the separate terminals is arbitrary):

- 1 / 2 = sensor S1 (flow temperature)
- 3 / 4 = sensor S2 (return temperature)
- 5 / 6 = flowmeter V40
- 9 / 10 = RESOL VBus®

The power supply connection is carried out via the terminals:

- 19 = neutral conductor N
- 20 = line L
- 12 / 13 / 14 = protective grounding terminals ⊕

1.3 Flowmeter



A flowmeter RESOL V40 is used in order to determine the volumetric flow rate in the solar circuit. The installation is to be carried out taking the flow direction into consideration (consider direction indication on the flowmeter). In order to tranquilize the flow ratio, an inlet and an outlet distance of 30 cm in front of and behind the flowmeter have to be taken into account.

Note: Versions V40 0.6 to 2.5 are suited for horizontal as well as for vertical installation. Versions V40 3.5 to 15 are for horizontal installation only. In order to avoid a pressure surge caused by cavitation in hydronic systems, the heat transfer fluid should be filled in when it is cold, and de-aerators should be used. Pressure surge and turbulent flow ratios lead to damage of the sensitive measuring instruments.

2. Operation and function
2.1 Push buttons for adjustment

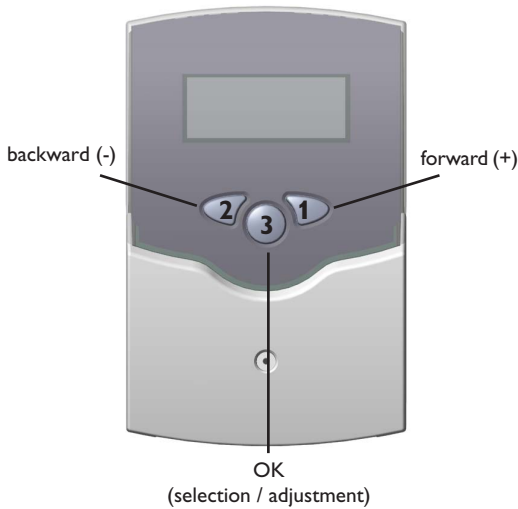

The WMZ is operated by 3 push buttons below the display. The forward-key (1) is used for scrolling forward through the indication menu or to increase the adjustment values. The backward-key (2) is used for scrolling backwards through the menu or to decrease adjustment values.

In order to change from the display level to the adjustment level, briefly press button 3. The indication changes to the adjustment mode.

- Select channel with buttons 1 and 2
- Briefly press button 3.
- Adjust value with the buttons 1 and 2
- Briefly press button 3. Answer the safety prompt “Save ?” with “yes” oder “no” (select with buttons 1 and 2) and confirm with button 3.

In order to get back to the display level, select the item “back”, and briefly press button 2.

Adjust. values:	
back	
▶ Antifr. type	Water
Flow measur.	V40

Safety prompt:	
Save?	Yes_

2.2 Graphic display

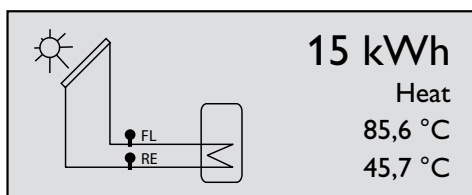

The WMZ has two display levels. In the 1st level, the heat quantity as well as flow and return temperatures are shown. Furthermore, it contains a system screen.

System screen: in the system screen, the system scheme and the sensors used are shown.

The 2nd level is the adjustment level in which various parameters and values can be adjusted.

2.3 LED flashing codes

- constant green: everything OK
- flashing green: sensor fault
(sensor symbol is flashing quickly)

3. Determining the ratio of the glycol-water mixture

(when using ready mixed fluids, pay attention to manufacturers' instructions)



Since the heat capacity of the heat transfer fluid depends on the concentration of glycol, the proportion of the glycol/water-mixture has to be determined first.

Determining the ratio for known volumes:

If the volumes of water and glycol in the system are known, the value in vol. % is calculated as follows:

$$\text{Vol \%} = \left(\frac{\text{VG}}{\text{VW} + \text{VG}} \right) \times 100$$

VG: volume of glycol

VW: volume of water

Example:

if 15 liters of water and 20 liters of glycol are used in the solar circuit, then follows:

$$\text{Vol \%} = \left(\frac{20}{15 + 20} \right) \times 100 = 57$$

Determining the ratio for unknown volumes:

RESOL refractometer:

In order to analyze the system, a small amount of fluid has to be withdrawn from the solar circuit and applied to the prism surface of the refractometer. Hold the pointy end against the light and turn the ocular until the borderlines become visible. The borderlines indicate the freezing temperature. In a table on the receptacle of the heat transfer fluid, the value for the vol.-% corresponding to the temperature value, is shown.

RESOL DHA125:

In order to analyze the system, a small amount of fluid has to be withdrawn from the solar circuit and filled into the measuring glass. With the measuring spindle, the density of the fluid can be determined which is converted into the mixing ratio with the aid of the table.

4. Function

During the calculation of the transferred heat quantity, the calorimeter RESOLWMZ takes into account that the specific heat capacity c and the density ρ depend on the temperature and the mixing proportion (access to limited values). Using these parameters, the measurement of the flow and return temperatures with two precision temperature sensors, and the evaluation of the impulses of a volumetric flowmeter, the WMZ calculates the transferred quantity.

This device can be used in systems which use water or water-propylene glycol mixtures as the heat transfer fluid. The proportion (in vol%) used in a system and the specification of the selected flowmeter (in liters per impulse) are adjusted locally after the installation.

5. Indication and adjustment channels

Display channels

- FL (flow temperature in °C)
- RE (return temperature in °C)
- heat quantity (in Wh or kWh respectively)
- volumetric flow rate
- power (in kW)

Adjustment channels

- antifreeze type
- antifreeze
- flow measurement (V40 or VTP)
- volume per impulse
- subaddress
- bus mode
- bus master
- sensor offset
- reset
- language

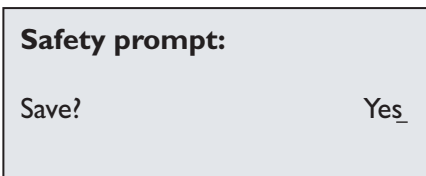

Note:

After a change in the adjustment channel has been made, a safety prompt appears. The adjustment is saved after the question has been confirmed with "yes".

5.1 Heat quantity

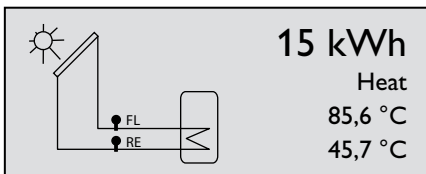

The determined heat quantity is indicated. If the heat quantity is smaller than 1 MWh, the quantity is indicated with the unit Wh. If the quantity is larger, it is indicated using the unit kWh.

5.2 Flow and return temperatures

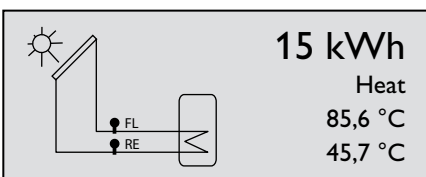

FL = indicates the current flow temperature
(example: 85.6 °C)

RE = indicates the current return temperature
(example: 45.7 °C)

5.3 Volumetric flow rate

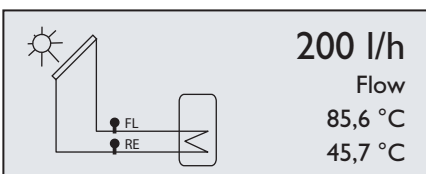

The volumetric flow rate is indicated (l/h).

5.4 Power

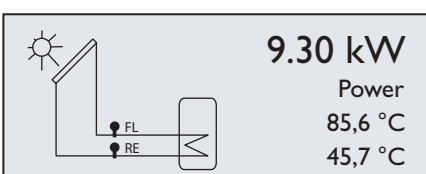

The current power is indicated (in kW).

Note:

The precision of the power indication depends on the flowmeter used. At low flow rates, deviations from the actual value are possible and caused by technical reasons!

5.5 Antifreeze type

Adjust. values:	
back	
▶ Antifr. type	Water
Flow measurement.	V40

Adjustment channel for the antifreeze type used. There are different types of heat transfer fluid to choose from. Water or water / glycol mixtures are used:

- water
- propylene
- ethylene
- Tyfo LS

5.6 Antifreeze

Adjust. values	
back	
Antifr. type	Propylene
▶ Antifreeze	40 %

Adjustment channel for the ratio of water / glycol ("antifreeze" is only visible, when the antifreeze type "propylene" or "glycol" has been selected before).

adjustment range: 20 % ... 70 vol. %

factory setting: 40 %

5.7 Type of flowmeter

Adjust. values:	
back	
Antifr. type	Water
▶ Flow measurement.	V40

Adjustment channel for the flowmeter type which is used. The factory setting is RESOL Flowmeter V40.

- V40
- VTP

5.8 Impulse Rate

Adjust. values:	
Antifr. type	Water
Flow. measurement.	V40
▶ Volume/Imp.	1,0 L/l

This adjustment channel depends on the selected flowmeter type.

If the flowmeter V40 is used, the value is indicated in L/l ("Volume/Imp" is indicated on the display).

adjustment range: 0.1 ... 99.9 L/l

If the flowmeter type VTP is used, the value is indicated in l/L ("heat" appears on the display)

adjustment range: 1 ... 2000 l/L

Note:

Pay attention to the indicated l/Imp on your flowmeter!

5.9 Subaddress

Adjust. values:	
Flow measurement.	V40
Volume/Imp.	1,0 L/l
▶ Subaddress	0

Adjustment of the subaddress. An individual module address for one WMZ can be adjusted. This way it is possible to use several WMZ with an individual address in one system. If several WMZ (up to max. 16) are connected to a PC or a datalogger, the calorimeters have to be numbered serially, starting with 0. The connection sequence at the VBus® is arbitrary.

adjustment range: 0 ... 15

5.10 Bus mode

Adjust. values:	
Volume/Imp.	1,0 L/I
Subaddress	0
▶ Bus mode	Cascded

Change of the bus mode: active, passive, or cascaded. Do not change the factory setting if the WMZ is connected to a RESOL controller with VBus® output terminal (corresponds to the bus mode “passive”).

Select bus mode “active“, if the WMZ is not connected to a controller and if data are recorded on a PC or datalogger. Select bus mode “cascaded“, if several WMZ are connected to a PC or datalogger. The WMZ modules are linearly numbered starting with 0 (see 5.9).

- active
- passive
- cascaded

5.11 Bus master

Adjust. values:	
Subaddress	0
Bus mode	Cascaded
▶ Bus master?	Yes

The item “bus master“ only appears when subadress “0“ and bus mode “cascaded“ have been selected.

Select bus master “No“ when several WMZ modules are cascaded and used along with a controller.

Select bus master “Yes“ when several WMZ modules are cascaded and used without a controller..

5.12 Sensor offset

Adjust. values:	
Bus master?	Yes
Sensor 1	0,0 K
▶ Sensor 2	0,0 K

In order to offset the sensors, an individual offset can be allocated to each sensor (range -5.0 K ... +5.0 K, in steps of 0.1 K).

5.13 Reset

Adjust. values:	
Subaddress	0
Bus mode	Cascaded
▶ Reset	

By means of this function, the measured heat quantity can be reset to the value 0.

5.14 Language

Adjust. values:	
Bus mode	Cascaded
Reset	
▶ Language	German

Selection of the language (German, English, French).

6. Examples of connection

6.1 WMZ module in individual operation mode



- WMZ: master board
subaddress: "0"
bus mode: "active"

6.2 WMZ with controller



- controller: register WMZ module
- WMZ: slave board
subaddress: "0"
bus mode: "passive"

6.3 Cascade without controller



- WMZ 0: master board
subaddress "0"
bus mode: "Cascaded"
bus master: "Yes"
- WMZ 1 ... 15: slave board
subaddress: 1 ... 15*
bus mode: "Cascaded"

The connection sequence at the VBus® is arbitrary.

6.4 Cascade with controller



- controller: No adjustments have to be made (**WMZ-module must not be registered!**)
- WMZ 0: slave board
subaddress: "0"
bus mode: "cascaded",
bus master: "No"
- WMZ 1 ... 15: Slave board
subaddress: 1 ... 15*
Bus mode: "Cascaded"

The connection sequence at the VBus® is arbitrary.

* The maximum number of cascaded WMZ modules is 16. Whether this number can be reached depends on the construction.

Disturbing factors can be the following: distances, voltage-carrying lines etc.

7. Troubleshooting

Please pay attention to the following items, if the calorimeter WMZ is not working properly.

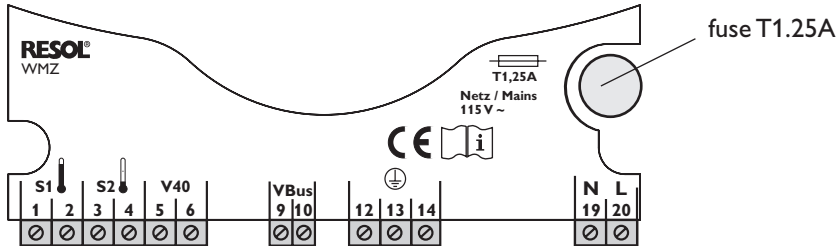

Operating control lamp flashes red.

Sensor defect. An error code instead of a temperature is shown in the corresponding sensor indication channel.

888.8

- 88.8

Line is broken.
Check the line.

Short circuit.
Check the line.

Pt1000 temperature sensors branched off can be checked with an ohmmeter. In the table shown below, the resistance values corresponding to different temperatures are listed.

°C	°F	Ω	°C	°F	Ω
-10	14	961	55	131	1213
-5	23	980	60	140	1232
0	32	1000	65	149	1252
5	41	1019	70	158	1271
10	50	1039	75	167	1290
15	59	1058	80	176	1309
20	68	1078	85	185	1328
25	77	1097	90	194	1347
30	86	1117	95	203	1366
35	95	1136	100	212	1385
40	104	1155	105	221	1404
45	113	1175	110	230	1423
50	122	1194	115	239	1442

Resistance values of the Pt1000-sensors

Operating control lamp off.

Check the power supply. Is it disconnected?

no

yes

The fuse of the device could be blown. It can be replaced after the front cover has been removed (spare fuse is enclosed in the accessory bag).

Check the supply line and reconnect it.

Notes

Notes

Notes

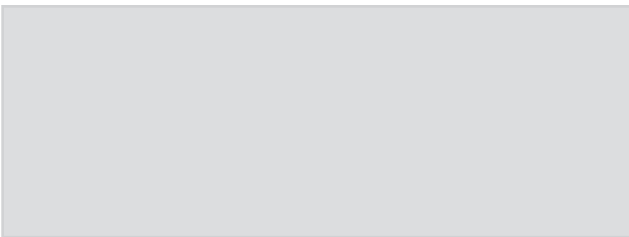
Distributed by:**RESOL – Elektronische Regelungen GmbH**

Heiskampstraße 10
45527 Hattingen / Germany
Tel.: +49 (0) 23 24 / 96 48 - 0
Fax: +49 (0) 23 24 / 96 48 - 755
www.resol.com
info@resol.com

Important notice:

We took a lot of care with the texts and drawings of this manual and to the best of our knowledge and consent. As faults can never be excluded, please note: Your own calculations and plans, under consideration of the current standards and directions should only be basis for your projects. We don't offer a guarantee for the completeness of the drawings and texts of this manual - they only represent some examples. They can only be used at your own risk. No liability is assumed for incorrect, incomplete or false information and the resulting damages.

Reprinting / copying

This mounting- and operation manual including all parts is copyrighted. Another use outside the copyright requires the approval of RESOL – Elektronische Regelungen GmbH. This especially applies for copies, translations, micro films and the storage into electronic systems.

Editor: RESOL – Elektronische Regelungen GmbH

Please note:

The design and the specifications are to be changed without notice. The illustrations may differ from the original product.