

DeltaSol[®] CS/4

RESOL[®]

Solar controller
Manual for the
specialised craftsman
Installation
Operation
Functions and options
Troubleshooting



11204293

Thank you for buying this RESOL product.
Please read this manual carefully to get the best performance from this unit.
Please keep this manual carefully.

en

Manual
www.resol.com

Safety advice

Please pay attention to the following safety advice in order to avoid danger and damage to people and property.

Danger of electric shock:

- When carrying out works, the device must first of all be disconnected from the mains.
- It must be possible to disconnect the device from the mains at any time.
- Do not use the device if it is visibly damaged.

The device must not be used by children or persons with reduced physical, sensory or mental abilities or without any experience and knowledge. Make sure that children do not play with the device!

Only connect accessories authorised by the manufacturer to the device.

Make sure that the housing is properly closed before commissioning the device.

Target group

These instructions are exclusively addressed to authorised skilled personnel.

Only qualified electricians are allowed to carry out electrical works.

Initial commissioning must be effected by authorised skilled personnel.

Authorised skilled personnel are persons who have theoretical knowledge and experience with the installation, commissioning, operation, maintenance, etc. of electric/electronic devices and hydraulic systems and who have knowledge of relevant standards and directives.

Instructions

Attention must be paid to the valid local standards, regulations and directives!

Subject to technical change. Errors excepted.

Information about the product

Proper usage

The solar controller is designed for electronically controlling standard solar thermal systems in compliance with the technical data specified in this manual.

Any use beyond this is considered improper.

Proper usage also includes compliance with the specifications given in this manual.

Improper use excludes all liability claims.



Note

Strong electromagnetic fields can impair the function of the device.

- ➔ Make sure the device as well as the system are not exposed to strong electromagnetic fields.

EU Declaration of conformity

The product complies with the relevant directives and is therefore labelled with the CE mark. The Declaration of Conformity is available upon request, please contact the manufacturer.



Scope of delivery

The scope of delivery of this product is indicated on the packaging label.

Storage and transport

Store the product at an ambient temperature of 0 ... 40 °C and in dry interior rooms only.

Transport the product in its original packaging only.

Cleaning

Clean the product with a dry cloth. Do not use aggressive cleaning fluids.

Decommissioning

1. Disconnect the device from the power supply.
2. Dismount the device.

Disposal

- Dispose of the packaging in an environmentally sound manner.
- At the end of its working life, the product must not be disposed of as urban waste. Old appliances must be disposed of by an authorised body in an environmentally sound manner. Upon request we will take back your old appliances bought from us and guarantee an environmentally sound disposal of the devices.



Description of symbols

Warnings are indicated with a warning symbol!

Signal words describe the danger that may occur, when it is not avoided.

WARNING means that injury, possibly life-threatening injury, can occur.



→ It is indicated how to avoid the danger described.

ATTENTION means that damage to the appliance can occur.



→ It is indicated how to avoid the danger described.



Note

Notes are indicated with an information symbol.

- Texts marked with an arrow indicate one single instruction step to be carried out
- 1. Texts marked with numbers indicate several successive instruction steps to be carried out.

Solar controller DeltaSol® CS/4

The DeltaSol® CS/4 controller is used for speed control of a HE pump in small standard solar thermal and heating systems.

It is equipped with a PWM output and an additional input for a VFD Grundfos Direct Sensor™ that enables a precise heat quantity measurement.

Contents

1	Overview	5
2	Installation	6
2.1	Mounting	6
2.2	Electrical connection	7
2.3	VFD Grundfos Direct Sensor™	8
2.4	PWM output.....	8
2.5	Data communication / Bus	8
2.6	System overview.....	8
2.7	Systems	9
3	Operation and function	20
3.1	Buttons	20
4	System-Monitoring-Display	20
4.1	Flashing codes	21
5	Commissioning.....	22
6	Channel overview	24
6.1	Display channels.....	24
6.2	Adjustment channels	27
7	Troubleshooting.....	37
8	Index	40

1 Overview

- Especially designed for the speed control of high-efficiency pumps
- 1 input for a VFD Grundfos Direct Sensor™
- System-Monitoring-Display
- Up to 4 Pt1000 temperature sensors
- Semiconductor relays for pump speed control
- HE pump control
- Heat quantity measurement
- Commissioning menu
- 3 basic systems to choose from
- Function control
- Optional thermal disinfection function
- Drainback option
- Unit °F and °C selectable

Dimensions and minimum distances

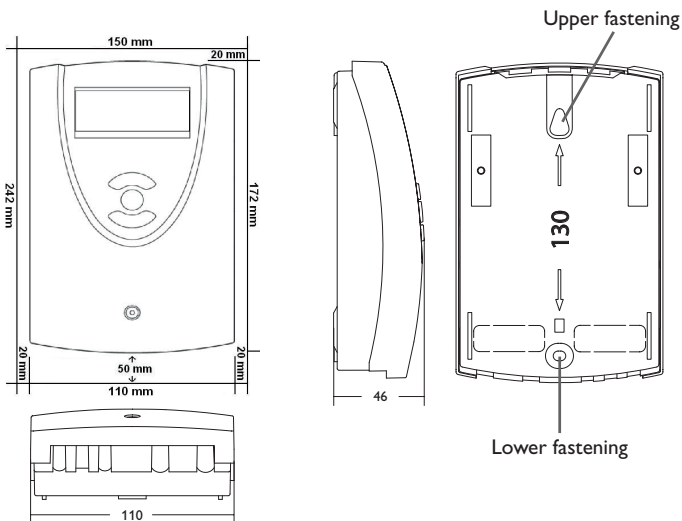

Technical data

Inputs: 4 Pt1000 temperature sensors, 1 VFD Grundfos Direct Sensor™

Outputs: 2 semiconductor relays, 1 PWM output

PWM frequency: 512 Hz

PWM voltage: 10.5 V

Switching capacity: 1 (1) A 240 V~ (semiconductor relay)

Total switching capacity: 2 A 240 V~

Power supply: 100–240 V~ (50–60 Hz)

Supply connection: type X attachment

Standby: 0.86 W

Temperature controls class: I

Energy efficiency contribution: 1 %

Mode of operation: type 1.C.Y action

Rated impulse voltage: 2.5 kV

Data interface: VBus®

VBus® current supply: 35 mA

Functions: function control, operating hours counter, tube collector function, thermostat function, speed control and heat quantity measurement

Housing: plastic, PC-ABS and PMMA

Mounting: wall mounting, mounting into patch panels is possible

Indication / Display: System-Monitoring-Display for visualisation of systems, 16-segment and 7-segment display, 8 symbols for indication of system status

Operation: 3 buttons

Ingress protection: IP 20 / EN 60529

Protection class: I

Ambient temperature: 0... 40 °C

Pollution degree: 2

Fuse: T2A

Maximum altitude: 2000 m above MSL

Dimensions: 172 x 110 x 46 mm

2 Installation

2.1 Mounting

WARNING! Electric shock!



Upon opening the housing, live parts are exposed!

→ **Always disconnect the device from power supply before opening the housing!**



Note

Strong electromagnetic fields can impair the function of the device.

→ Make sure the device as well as the system are not exposed to strong electromagnetic fields.

The unit must only be located in dry interior rooms.

If the device is not equipped with a mains connection cable and a plug, the device must additionally be supplied from a double pole switch with contact gap of at least 3 mm.

Please pay attention to separate routing of sensor cables and mains cables.

In order to mount the device to the wall, carry out the following steps:

1. Unscrew the crosshead screw from the cover and remove it along with the cover from the housing.
2. Mark the upper fastening point on the wall. Drill and fasten the enclosed wall plug and screw leaving the head protruding.
3. Hang the housing from the upper fastening point and mark the lower fastening point (centres 130 mm).
4. Insert lower wall plug.
5. Fasten the housing to the wall with the lower fastening screw and tighten.
6. Carry out the electrical wiring in accordance with the terminal allocation (see chapter 2.2).
7. Put the cover on the housing.
8. Attach with the fastening screw.

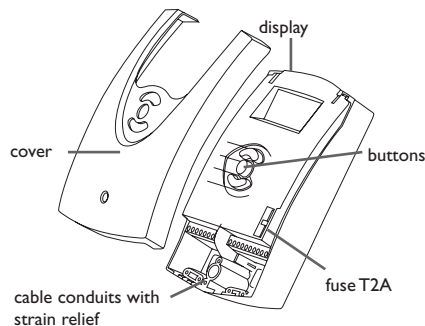

2.2 Electrical connection

WARNING! Electric shock!



Upon opening the housing, live parts are exposed!
→ Always disconnect the device from power supply before opening the housing!

ATTENTION! ESD damage!



Electrostatic discharge can lead to damage to electronic components!
→ Take care to discharge properly before touching the inside of the device!



Note

Connecting the device to the power supply must always be the last step of the installation!



Note

The mains connection must be carried out with the common ground of the building to which the pipework of the solar circuit is connected.



Note

The pump speed must be set to 100% when auxiliary relays or valves are connected.



Note

It must be possible to disconnect the device from the mains at any time.
→ Install the mains plug such that it is accessible at any time.
→ If this is not possible, install a switch that can be accessed.
 If the mains cable is damaged, it must be replaced by a special connection cable which is available from the manufacturer or its customer service.

Do not use the device if it is visibly damaged!

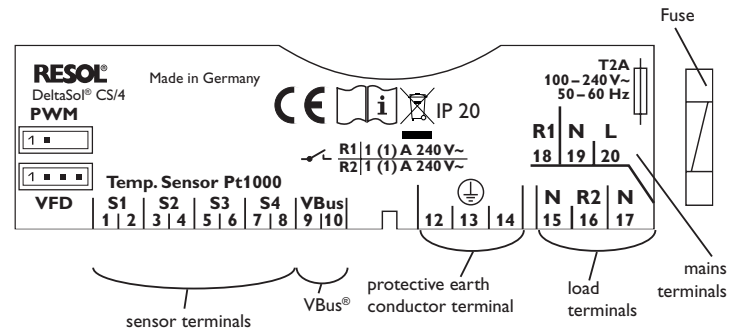

The power supply of the device must be 100 ... 240V~ (50 ... 60Hz). Attach flexible cables to the housing with the enclosed strain relief and the corresponding screws. The controller is equipped with 2 semiconductor relays to which **loads** such as pumps, valves, etc. can be connected:

Relay 1

18 = Conductor R1
 17 = Neutral conductor N
 13 = Protective earth conductor ⊕

Relay 2

16 = Conductor R2
 15 = Neutral conductor N
 14 = Protective earth conductor ⊕

The **mains connection** is at the following terminals:

19 = Neutral conductor N
 20 = Conductor L
 12 = Protective earth conductor ⊕

Connect the **temperature sensors** (S1 to S4) to the corresponding terminals with either polarity:

1/2 = Sensor 1 (e. g. collector sensor 1)
 3/4 = Sensor 2 (e. g. store sensor 1)
 5/6 = Sensor 3 (e. g. store sensor top)
 7/8 = Sensor 4 (e. g. return sensor)

The cables carry low voltage and must not run together in a cable conduit with cables carrying a voltage higher than 50 V (please pay attention to the valid local regulations). The cable lengths depend on the cross sectional area.

Example: up to 100 m at 1.5 mm², up to 50 m at 0.75 mm². The cables can be extended with a two-wire cable.

2.3 VFD Grundfos Direct Sensor™

The controller is equipped with 1 input for a digital VFD Grundfos Direct Sensor™ for measuring the flow rate and the temperature. Connection is made at the VFD terminal.

2.4 PWM output

Speed control of a HE pump is possible via a PWM signal. The pump has to be connected to the relay as well as to the PWM output of the controller. Power is supplied to the HE pump by switching the corresponding relay on or off.

The two pins on the left-hand side of the connector marked **PWM** are the control output for a pump with PWM input. The two pins on the right-hand side are not used.

PWM

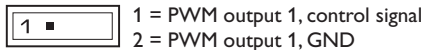

1 2

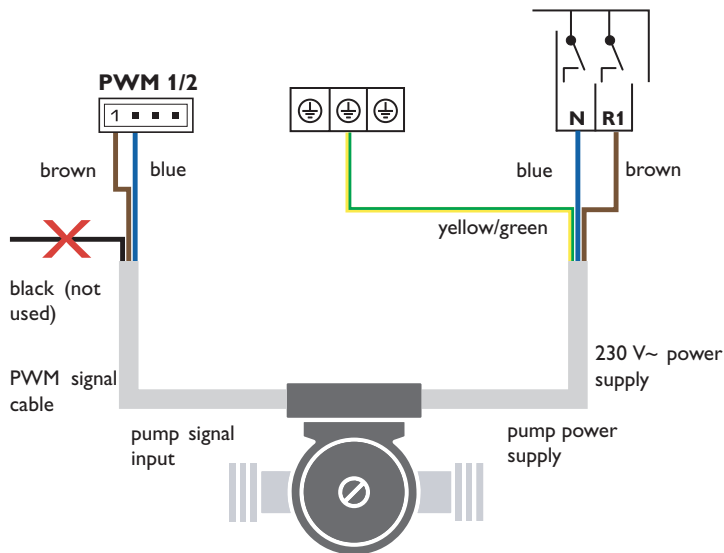

2.5 Data communication / Bus

The controller is equipped with the **VBUS®** for data transfer and energy supply to external modules. The connection is to be carried out at the terminals marked **VBUS** (either polarity).

One or more **VBUS®** modules can be connected via this data bus.

2.6 System overview

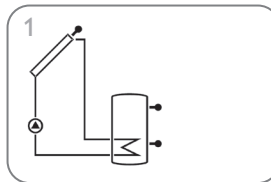

Standard solar system (page 9)

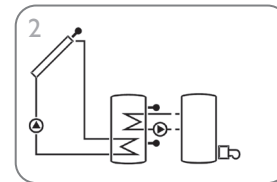

Solar system with backup heating (page 12)

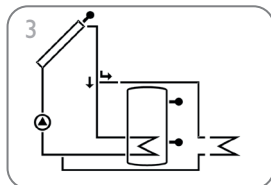

Standard solar system with heat dump (page 17)

Arrangement 1: Standard solar system

The controller calculates the temperature difference between collector sensor S1 and store sensor S2. If the difference is larger than or identical to the adjusted switch-on temperature difference (DT O), the solar pump will be activated by relay 1, and the store will be loaded until the switch-off temperature difference (DT F) or the maximum store temperature (SMX) is reached.

Sensors S3 and S4 can optionally be connected. S3 can optionally be used as the reference sensor for the store emergency shutdown option (OSEM). If heat quantity measurement (OHQM) is activated, S4 is used as the return sensor. If the drainback option (ODB) is activated, relay 2 can be used for activating a booster pump. For this purpose, the booster function (OBST) has to be activated.

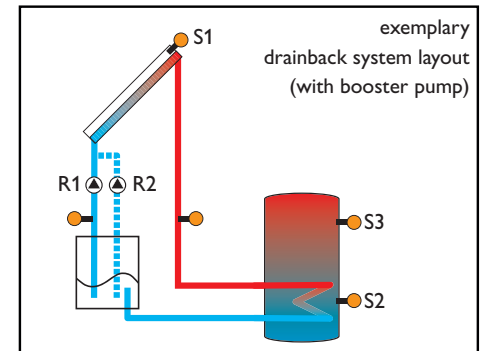
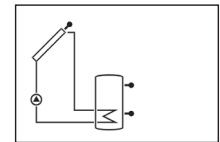
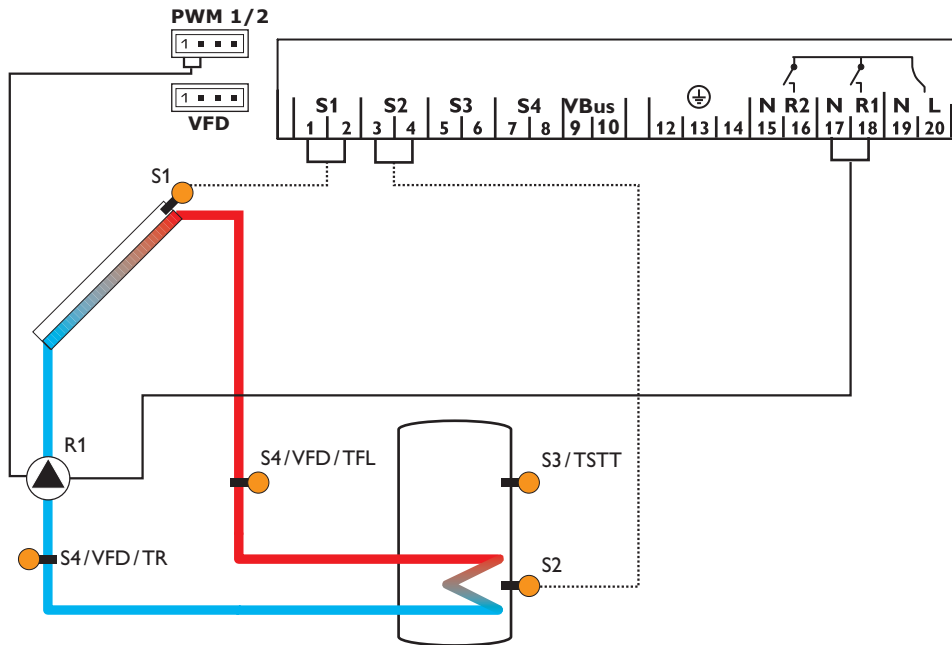

Display channels

Channel		Description	Connection terminal	Page
INIT	x*	ODB initialisation active	-	24
FLL	x*	ODB filling time active	-	24
STAB	x*	ODB stabilisation in progress	-	24
COL	x	Temperature collector	S1	25
TST	x	Temperature store	S2	25
S3	x	Temperature sensor 3	S3	25
TSTT	x*	Temperature store top	S3	25
S4	x	Temperature sensor 4	S4	25
TFL	x*	Temperature flow sensor	S1 / S4 / VFD	25
TR	x*	Temperature return sensor	S4 / VFD	25
VFD	x*	Temperature Grundfos Direct Sensor™	VFD	25
L/h	x*	Flow rate Grundfos Direct Sensor™	VFD	26
n%	x	Speed R1	R1	26
hP	x	Operating hours R1	R1	27
hP1	x*	Operating hours R1 (if OBST is activated)	R1	27
hP2	x*	Operating hours R2 (if OBST is activated)	R2	27
kWh	x*	Heat quantity in kWh	-	26
MWh	x*	Heat quantity in MWh	-	26
TIME	x	Time	-	27

Adjustment channels

Channel		Description	Factory setting	Page
Arr	x	System	1	27
DT O	x	Switch-on temperature difference R1	6.0 K [12.0 °Ra]	28
DT F	x	Switch-off temperature difference R1	4.0 K [8.0 °Ra]	28
DT S	x	Set temperature difference R1	10.0 K [20.0 °Ra]	28
RIS	x	Rise R1	2 K [4 °Ra]	28
PUM1	x	Pump control type R1	PSOL	29
nMN	x	Minimum speed R1	30%	29
nMX	x	Maximum speed R1	100%	29
S MX	x	Maximum store temperature	60 °C [140 °F]	29
OSEM	x	Store emergency shutdown option	OFF	30
EM	x	Collector emergency temperature	130 °C [270 °F]	30
		Collector emergency temperature if ODB is activated:	95 °C [200 °F]	30
OCC	x	Collector cooling option	OFF	30
CMX	x*	Maximum collector temperature	110 °C [230 °F]	30
OSYC	x	System cooling option	OFF	31

Adjustment channels

Channel		Description	Factory setting	Page
DTCO	x*	Switch-on temperature difference cooling	20.0 K [40.0 °Ra]	31
DTCF	x*	Switch-off temperature difference cooling	15.0 K [30.0 °Ra]	31
OSTC	x	Store cooling option	OFF	31
OHOL	x*	Holiday cooling option	OFF	31
THOL	x*	Holiday cooling temperature	40 °C [110 °F]	31
OCN	x	Collector minimum limitation option	OFF	32
CMN	x*	Collector minimum temperature	10 °C [50 °F]	32
OCF	x	Antifreeze option	OFF	32
CFR	x*	Antifreeze temperature	4.0 °C [40.0 °F]	32
OTC	x	Tube collector option	OFF	32
TCST	x*	OTC starting time	07:00	32
TCEN	x*	OTC ending time	19:00	32
TCRU	x*	OTC runtime	30 s	32
TCIN	x*	OTC standstill interval	30 min	33
GFD	x	Grundfos Direct Sensor™	OFF	33
OHQM	x	Heat quantity measurement option	OFF	33
SEN	x*	VFD allocation	2	34
FMAX	x*	Maximum flow rate	6.0 l/min	33
MEDT	x*	Antifreeze type	1	34
MED%	x*	Antifreeze concentration (only if MEDT = propylene or ethylene glycol)	45 %	34
ODB	x	Drainback option	OFF	34
tDTO	x*	ODB switch-on condition - time period	60 s	35
tFLL	x*	ODB filling time	5.0 min	35
tSTB	x*	ODB stabilisation time	2.0 min	35
OBST	s*	Option booster function	OFF	35
MAN1	x	Manual mode R1	Auto	35
MAN2	x	Manual mode R2	Auto	35
LANG	x	Language	dE	36
UNIT	x	Temperature unit	°C	36
RESE	x	Reset - back to factory settings		36
#####		Version number		

Legend:

Symbol	Description
x	Channel is available
x*	Channel is available, if the corresponding option is activated.
s*	System-specific channel, only available if the corresponding option is activated

Arrangement 2: Solar system with backup heating

The controller calculates the temperature difference between collector sensor S1 and store sensor S2. If the difference is larger than or identical to the adjusted switch-on temperature difference (DT O), the solar pump will be activated by relay 1, and the store will be loaded until the switch-off temperature difference (DT F) or the maximum store temperature (SMX) is reached.

Sensor S3 is used for a thermostat function, which operates relay 2 for backup heating or heat dump purposes, when the adjusted thermostat switch-on tempera-

ture (AH O) is reached. This function can optionally be combined with up to three adjustable time frames.

Sensor S3 can optionally be used as the reference sensor for the thermal disinfection function (OTD) or the store emergency shutdown option (OSEM).

Sensor S4 can optionally be connected. If heat quantity measurement (OHQM) is activated, S4 and VFD are used as the flow and return sensors respectively.

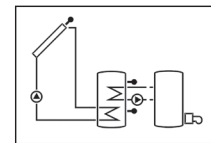
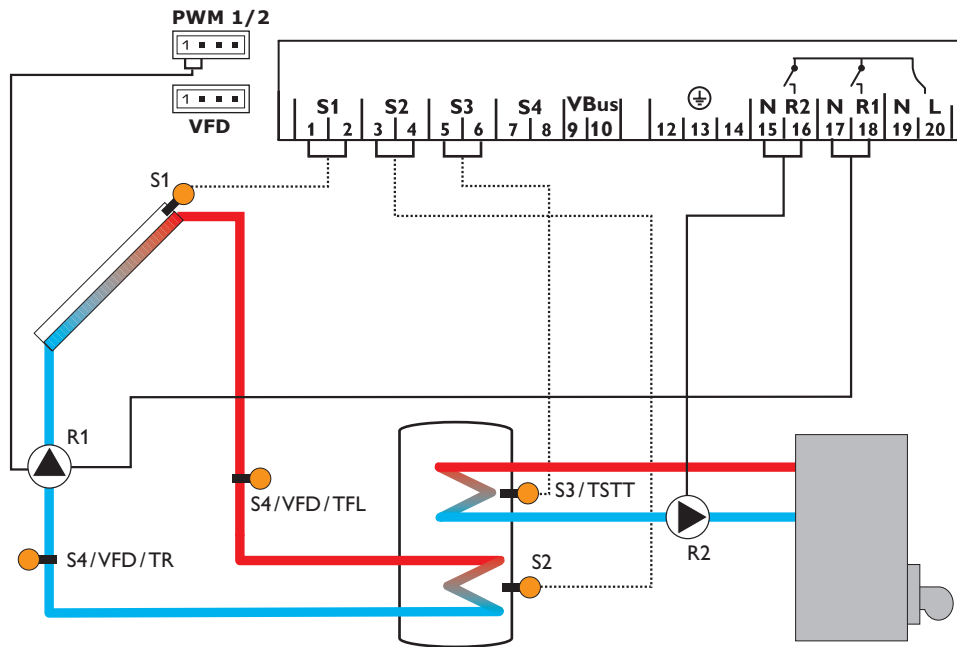

Display channels				
Channel		Description	Connection terminal	Page
INIT	x*	ODB initialisation active	-	24
FLL	x*	ODB filling time active	-	24
STAB	x*	ODB stabilisation in progress	-	24
COL	x	Temperature collector	S1	25
TSTB	x	Temperature store 1 base	S2	25
TSTT	x	Temperature store 1 top	S3	25
TDIS	s*	Thermal disinfection temperature (thermal disinfection)	S3	25
S4	x	Temperature sensor 4	S4	25
TFL	x*	Temperature flow sensor	S1/S4/VFD	25
TR	x*	Temperature return sensor	S4/VFD	25
VFD	x*	Temperature Grundfos Direct Sensor™	VFD	25
L/h	x*	Flow rate Grundfos Direct Sensor™	VFD	26
n1%	x	Speed R1	R1	26
h P1	x	Operating hours R1	R1	27
h P2	x	Operating hours R2	R2	27
kWh	x*	Heat quantity in kWh	-	26
MWh	x*	Heat quantity in MWh	-	26
CDIS	s*	Countdown of monitoring period (thermal disinfection)	-	26
SDIS	s*	Starting time display (thermal disinfection)	-	26
DDIS	s*	Heating period display (thermal disinfection)	-	26
TIME	x	Time	-	27

Adjustment channels				
Channel		Description	Factory setting	Page
Arr	x	System	2	27
DT O	x	Switch-on temperature difference R1	6.0 K [12.0 °Ra]	28
DT F	x	Switch-off temperature difference R1	4.0 K [8.0 °Ra]	28
DT S	x	Set temperature difference R1	10.0 K [20.0 °Ra]	28
RIS	x	Rise R1	2 K [4 °Ra]	28
PUM1	x	Pump control type R1	PSOL	29
n1MN	x	Minimum speed R1	30%	29
n1MX	x	Maximum speed R1	100%	29
S MX	x	Maximum store temperature	60 °C [140 °F]	29
OSEM	x	Store emergency shutdown option	OFF	30
EM	x	Collector emergency temperature	130 °C [270 °F]	30
		Collector emergency temperature if ODB is activated:	95 °C [200 °F]	30
OCC	x	Collector cooling option	OFF	30
CMX	x*	Maximum collector temperature	110 °C [230 °F]	30
OSYC	x	System cooling option	OFF	31
DTCO	x*	Switch-on temperature difference cooling	20.0 K [40.0 °Ra]	31
DTCF	x*	Switch-off temperature difference cooling	15.0 K [30.0 °Ra]	31
OSTC	x	Store cooling option	OFF	31
OHOL	x*	Holiday cooling option	OFF	31
THOL	x*	Holiday cooling temperature	40 °C [110 °F]	31

Adjustment channels

Channel		Description	Factory setting	Page
OCN	x	Collector minimum limitation option	OFF	32
CMN	x*	Collector minimum temperature	10 °C [50 °F]	32
OCF	x	Antifreeze option	OFF	32
CFR	x*	Antifreeze temperature	4.0 °C [40.0 °F]	32
OTC	x	Tube collector option	OFF	32
TCST	x*	OTC starting time	07:00	32
TCEN	x*	OTC ending time	19:00	32
TCRU	x*	OTC runtime	30 s	32
TCIN	x*	OTC standstill interval	30 min	33
GFD	x	Grundfos Direct Sensor™	OFF	33
OHQM	x	Heat quantity measurement option	OFF	33
SEN	x*	VFD allocation	2	34
FMAX	x*	Maximum flow rate	6.0 l/min	33
MEDT	x*	Antifreeze type	1	34
MED%	x*	Antifreeze concentration	45%	34
AH O	s	Switch-on temperature for thermostat	40 °C [110 °F]	15
AH F	s	Switch-off temperature for thermostat	45 °C [120 °F]	15
t1 O	s	Thermostat switch-on time 1	00:00	15
t1 F	s	Thermostat switch-off time 1	00:00	15
t2 O	s	Thermostat switch-on time 2	00:00	15
t2 F	s	Thermostat switch-off time 2	00:00	15
t3 O	s	Thermostat switch-on time 3	00:00	15
t3 F	s	Thermostat switch-off time 3	00:00	15
ODB	x	Drainback option	OFF	34
tDTO	x*	ODB switch-on condition - time period	60 s	35
tFLL	x*	ODB filling time	5.0 min	35
tSTB	x*	ODB stabilisation time	2.0 min	35
OTD	s	Thermal disinfection option	OFF	16
PDIS	s*	Monitoring period	01:00	16
DDIS	s*	Heating period	01:00	16
TDIS	s*	Disinfection temperature	60 °C [140 °F]	16
SDIS	s*	Starting time	00:00	16
MAN1	x	Manual mode R1	Auto	35
MAN2	x	Manual mode R2	Auto	35
LANG	x	Language	dE	36
UNIT	x	Temperature unit	°C	36
RESE	x	Reset - back to factory settings		36
#####		Version number		

Legend:

Symbol	Description
x	Channel is available
x*	Channel is available, if the corresponding option is activated.
s	System-specific channel
s*	System-specific channel, only available if the corresponding option is activated

System-specific functions

The following adjustments are used for the specific functions in system 3. The channels described are not available in any other systems.

Thermostat function

Backup heating

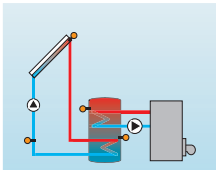

Use of surplus energy

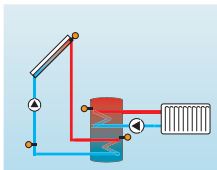

The thermostat function works independently from the solar operation and can be used for using surplus energy or for backup heating.

- **AH O < AH F**
thermostat function for backup heating
- **AH O > AH F**
thermostat function for using surplus energy

The symbol  will be shown on the display, if the second relay output is activated.

S3 is used as the reference sensor for the thermostat function.



AH O

Thermostat switch-on temperature

Adjustment range: 0.0 ... 95.0 °C [30.0 ... 200.0 °F]

Factory setting: 40.0 °C [110.0 °F]



AH F

Thermostat switch-off temperature

Adjustment range: 0.0 ... 95.0 °C [30.0 ... 200.0 °F]

Factory setting: 45.0 °C [120.0 °F]



t1 O, t2 O, t3 O

Thermostat switch-on time

Adjustment range: 00:00 ... 23:45

Factory setting: 00:00



t1 F, t2 F, t3 F

Thermostat switch-off time

Adjustment range: 00:00 ... 23:45

Factory setting: 00:00

In order to block the thermostat function for a certain period, there are 3 time frames t1 ... t3.

If the thermostat function is supposed to run from 06:00 a.m. to 09:00 a.m. only, adjust **t1 O** to 06:00 a.m. and **t1 F** to 09:00 a.m.

If the switch-on and switch-off times of a time frame are set to an identical value, the time frame will be inactive. If all time frames are set to 00:00, the thermostat function is solely temperature dependent (factory setting).

Thermal disinfection of the upper DHW zone



OTD

Therm. disinfection function
Adjustment range: OFF/ON
Factory setting: OFF

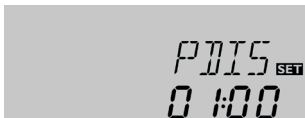

PDIS

Monitoring period
Adjustment range: 0 ... 30:0 ... 24 h (dd:hh)
Factory setting: 01:00

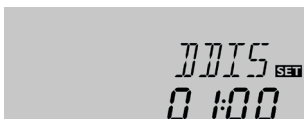

DDIS

Heating period
Adjustment range: 0:00 ... 23:59 (hh:mm)
Factory setting: 01:00



TDIS

Disinfection temperature
Adjustment range: 0 ... 95 °C [30 ... 200 °F]
Factory setting: 60 °C [140 °F]

This function helps to contain the spread of Legionella in DHW stores by systematically activating the backup heating.

For thermal disinfection, the temperature at the reference sensor will be monitored. Protection is ensured when, during the monitoring period, the disinfection temperature is continuously exceeded for the entire disinfection period.

The monitoring period starts as soon as the temperature at the reference sensor falls below the disinfection temperature. When the monitoring period ends, the allocated reference relay activates the backup heating. The disinfection period starts, if the temperature at the allocated sensor exceeds the disinfection temperature.

Thermal disinfection can only be completed when the disinfection temperature is exceeded for the duration of the disinfection period without any interruption.

Starting time delay

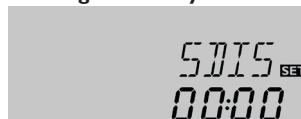

SDIS

Starting time
Adjustment range: 0:00 ... 24:00 (time)
Factory setting: 00:00

If the starting delay option is activated, a starting time for the thermal disinfection with starting delay can be adjusted. The activation of the backup heating is then delayed until that starting time after the monitoring period has ended.

If the monitoring period ends, for example, at 12:00 o'clock, and the starting time has been set to 18:00, the reference relay will be energised with a delay of 6 hours at 18:00 instead of 12:00 o'clock.



Note

If the thermal disinfection option is activated, the display channels **TDIS**, **CDIS**, **SDIS** and **DDIS** will be displayed.

Arrangement 3: Standard solar system with heat dump

The controller calculates the temperature difference between collector sensor S1 and store sensor S2. If the difference is larger than or identical to the adjusted switch-on temperature difference (DT O), the solar pump will be activated by relay 1, and the store will be loaded until the switch-off temperature difference (DT F) or the maximum store temperature (SMX) is reached.

If the collector maximum temperature (CMX) is reached, the solar pump will be activated by R1 and the 3-port valve by R2 in order to divert excess heat to a heat

sink. For safety reasons, excess heat dump will only take place as long as the store temperature is below the non-adjustable shutdown temperature of 95 °C [200 °F].

Sensors S3 and S4 can optionally be connected. S3 can optionally be used as the reference sensor for the store emergency shutdown option (OSEM).

If heat quantity measurement (OHQM) is activated, S4 and VFD are used as the flow and return sensors respectively.

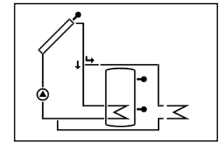
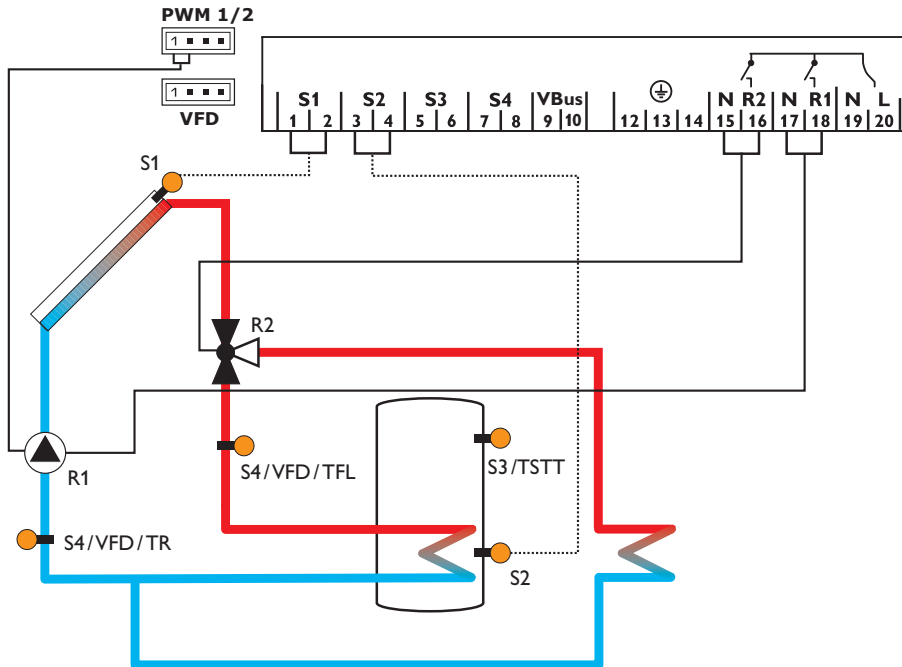

Display channels				
Channel		Description	Connection terminal	Page
COL	x	Temperature collector	S1	25
TST	x	Temperature store	S2	25
S3	x	Temperature sensor 3	S3	25
TSTT	x*	Temperature store top	S3	25
S4	x	Temperature sensor 4	S4	25
TFL	x*	Temperature flow sensor	S1/S4/VFD	25
TR	x*	Temperature return sensor	S4/VFD	25
VFD	x*	Temperature Grundfos Direct Sensor™	VFD	25
L/h	x*	Flow rate Grundfos Direct Sensor™	VFD	26
n%	x	Speed relay R1	R1	26
h P1	x	Operating hours R1	R1	27
h P2	x	Operating hours R2	R2	27
kWh	x*	Heat quantity in kWh	-	26
MWh	x*	Heat quantity in MWh	-	26
TIME	x	Time	-	27

Adjustment channels				
Channel		Description	Factory setting	Page
Arr	x	System	3	27
DT O	x	Switch-on temperature difference R1	6.0 K [12.0 °Ra]	28
DT F	x	Switch-off temperature difference R1	4.0 K [8.0 °Ra]	28
DT S	x	Set temperature difference R1	10.0 K [20.0 °Ra]	28
RIS	x	Rise R1	2 K [4 °Ra]	28
PUM1	x	Pump control type R1	PSOL	29
nMN	x	Minimum speed R1	30%	29
nMX	x	Maximum speed R1	100%	29
S MX	x	Maximum store temperature	60 °C [140 °F]	28
OSEM	x	Store emergency shutdown option	OFF	28
EM	x	Collector emergency temperature	130 °C [270 °F]	28
CMX	s	Maximum collector temperature	110 °C [230 °F]	30
OCN	x	Collector minimum limitation option	OFF	32
CMN	x*	Collector minimum temperature	10 °C [50 °F]	32
OCF	x	Antifreeze option	OFF	32
CFR	x*	Antifreeze temperature	4.0 °C [40.0 °F]	32
OTC	x	Tube collector option	OFF	32
TCST	x*	OTC starting time	07:00	32
TCEN	x*	OTC ending time	19:00	32

Adjustment channels				
Channel		Description	Factory setting	Page
TCRU	x*	OTC runtime	30 s	32
TCIN	x*	OTC standstill interval	30 min	33
GFD	x	Grundfos Direct Sensor™	OFF	33
OHQM	x	Heat quantity measurement option	OFF	33
SEN	x*	VFD allocation	2	34
FMAX	x*	Maximum flow rate	6.0 l/min	33
MEDT	x*	Antifreeze type	1	34
MED%	x*	Antifreeze concentration (only if MEDT = propylene or ethylene glycol)	45 %	34
MAN1	x	Manual mode R1	Auto	35
MAN2	x	Manual mode R2	Auto	35
LANG	x	Language	dE	36
UNIT	x	Temperature unit	°C	36
RESE	x	Reset - back to factory settings		36
#####		Version number		

Legend:

Symbol	Description
x	Channel is available
x*	Channel is available, if the corresponding option is activated.

3 Operation and function

3.1 Buttons

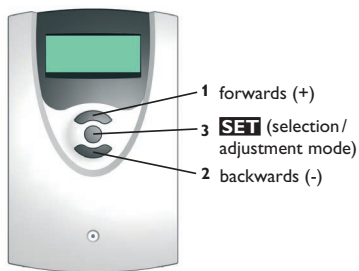

The controller is operated via the 3 buttons below the display.

Button 1 (+) is used for scrolling forwards through the menu and increasing adjustment values. **Button 2 (-)** is used for scrolling backwards through the menu and reducing adjustment values. **Button 3 (OK)** is used for selecting channels and confirming adjustments.

During normal operation, display channels will be displayed.

➔ In order to scroll between display channels, press buttons 1 and 2.

Access to adjustment channels:

➔ Use button 1 in order to scroll to the last display channel, then press and hold down button 1 for approx. 2 s.

If an **adjustment channel** is shown on the screen, **SET** will be displayed on the right-hand side next to the channel name.

1. Press button 3 in order to select an adjustment channel.

SET starts flashing.

2. Adjust the desired value with buttons 1 and 2.

3. Briefly press button 3.

SET permanently appears, the adjusted value has been saved.

4 System-Monitoring-Display

System-Monitoring-Display

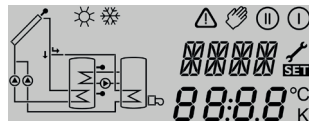

The System-Monitoring-Display consists of 3 blocks: channel display, tool bar and system screen.

Channel display



The channel display consists of 2 lines. The upper display line is an alphanumeric 16-segment display. In this line, mainly channel names and menu items are displayed. In the lower 16-segment display, values are displayed.

Tool bar

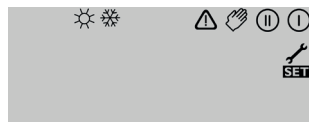

The additional symbols in the tool bar indicate the current system state.

Permanently shown	Flashing	Status indications:
①		Relay 1 active
②		Relay 2 active
☀		Maximum store temperature exceeded
	⚠ + ☀	Store emergency shutdown active
	⚠	Collector emergency shutdown active
①	☀	Collector cooling active
①	☀	System cooling active
① + ☀		Store cooling active
☀	⚠	Holiday cooling option activated
① + ☀	⚠	Holiday cooling active
	☀	Collector minimum limitation active
☀		Antifreeze function activated
① / ②	☀	Antifreeze function active
👤 + ①	⚠	Manual mode relay 1 ON
👤 + ②	⚠	Manual mode relay 2 ON
👤	⚠	Manual mode relay 1/2 OFF
🔧	⚠	Sensor fault

4.1 Flashing codes

- Pumps are flashing when the corresponding relay is switched on
- Sensor symbols are flashing, if the corresponding sensor display channel is selected
- Sensors are flashing quickly in the case of a sensor fault
- Burner symbol is flashing if the backup heating is active

System screen

The system selected is indicated in the System-Monitoring-Display. It consists of several system component symbols which are – depending on the current status of the system – either flashing, permanently shown or not indicated.

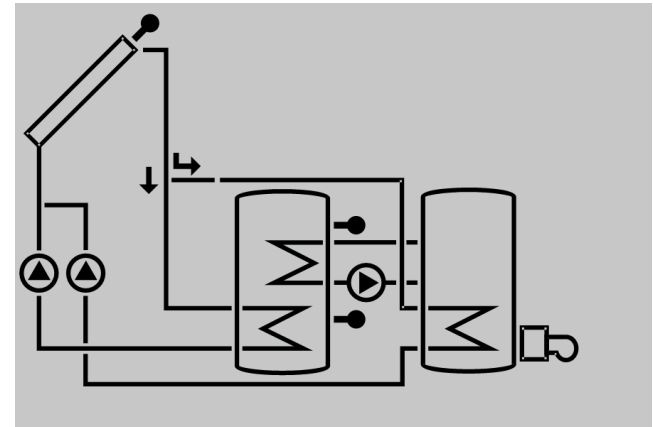

Collector
with collector sensor



Temperature sensor



Store
with heat exchanger



Pump



3-port valve
Only the flow direction or current switching position is indicated.



Backup heating
with burner symbol

5 Commissioning

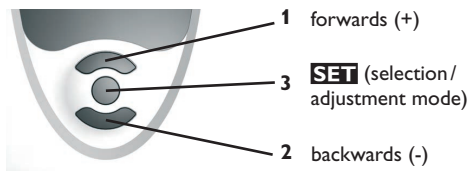

→ Connect the device to the mains

The controller runs an initialisation phase.

When the controller is commissioned or when it is reset, it will run a commissioning menu. The commissioning menu leads the user through the most important adjustment channels needed for operating the system.

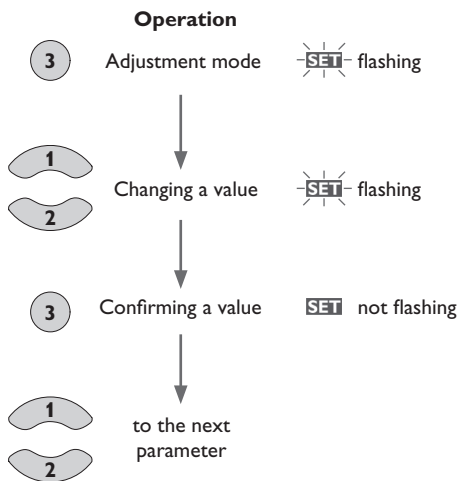

Commissioning

1. Language

→ Adjust the desired menu language.

LANG

Language selection

Selection: dE, En, Fr, ES, It

Factory setting: dE

2. Temperature unit

→ Adjust the desired unit.

UNIT

Temperature unit

Selection: °F, °C

Factory setting: °C

3. Time

→ Adjust the clock time.

First of all adjust the hours, then the minutes.

TIME

Real time clock

4. Arrangement

→ Adjust the desired system.

For a detailed description of the systems to choose from, see page 9.

Arr

System selection

Adjustment range: 1 ... 3

Factory setting: 1

If the system selection is changed later on, any previous adjustments which have been made in the other channels will be lost. Therefore, changing the system is always followed by a security enquiry.

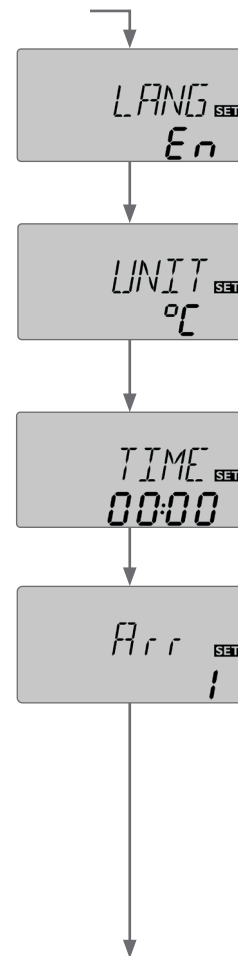

Commissioning

Only confirm the security enquiry if you are sure that you wish to change the system selection.

Security enquiry:

→ In order to confirm the security enquiry, press button 3.

5. Maximum store temperature

→ Adjust the desired maximum store temperature.

SMX

Maximum store temperature

Adjustment range: 4 ... 95 °C [40 ... 200 °F]

Arr 3: 4 ... 90 °C [40 ... 190 °F]

Factory setting: 60 °C [140 °F]



Note

The controller is also equipped with a non-adjustable emergency shutdown, deactivating the system if the store reaches 95 °C [200 °F].

6. Pump control type

→ Adjust the pump control type.

PUM

Pump control type

Selection: OnOF, PULS, PSOL, PHEA

Factory setting: PSOL

The following types can be selected:

Adjustment for standard pump without speed control

- OnOF (pump on/pump off)

Adjustment for standard pump with speed control

- PULS (burst control via semiconductor relay)

Adjustment for high-efficiency pump (HE pump)

- PSOL (PWM profile for a HE solar pump)
- PHEA (PWM profile for a HE heating pump)

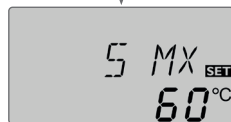

Commissioning

7. Minimum speed

→ Adjust the minimum speed for the corresponding pump.

nMN

Minimum speed

Adjustment range: (10) 30 ... 100 %

Factory setting: 30 %



Note

The pump speed must be set to 100% when auxiliary relays or valves are connected.

8. Maximum speed

→ Adjust the maximum speed for the corresponding pump.

nMX

Maximum speed

Adjustment range: (10) 30 ... 100 %

Factory setting: 100 %



Note

The pump speed must be set to 100% when auxiliary relays or valves are connected.

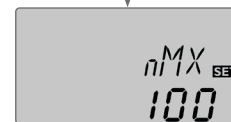
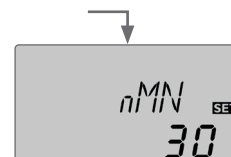

Confirmation

Completing the commissioning menu

After the last channel of the commissioning menu has been adjusted and confirmed, the controller asks for confirmation of the adjustments.

→ In order to confirm the adjustments made in the commissioning menu, press button 3.

The controller is then ready for operation with the adjustments made for the system selected .

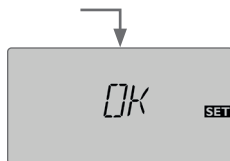

Note

The adjustments carried out during commissioning can be changed anytime in the corresponding adjustment channel. Additional functions and options can also be activated or deactivated (see page 27).

6 Channel overview

6.1 Display channels



Note

The display and adjustment channels as well as the adjustment ranges depend on the system selected, the functions and options as well as on the system components connected to the controller.

Display of drainback time periods

Initialisation

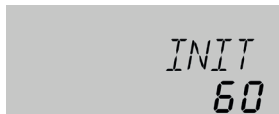

INIT

ODB initialisation active

Indicates the time adjusted in tDTO, running backwards.

Filling time



FLL

ODB filling time active

Indicates the time adjusted in tFLL, running backwards.

Stabilisation

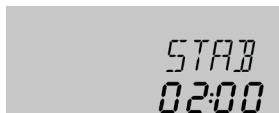

STAB

ODB stabilisation in progress

Indicates the time adjusted in tSTB, running backwards.

Display of collector temperatures



COL

Collector temperature

Display range: -40 ... +260 °C [-40 ... +500 °F]

Indicates the collector temperatures.

Display of store temperatures

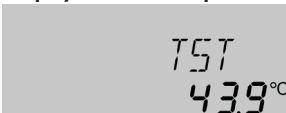

TST, TSTB, TSTT, TDIS

Store temperatures

Display range: -40 ... +260 °C [-40 ... +500 °F]

Indicates the store temperatures.

- TST : Store temperature (1-store system)
- TSTB : Store temperature base
- TSTT : Store temperature top
- TDIS : Thermal disinfection temperature

(Arr = 3 only; replaces TSTT if, during thermal disinfection, the heating period DDIS is active)

Display of sensors 3, 4 and VFD

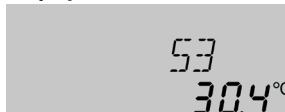

S3, S4, VFD

Sensor temperatures

Display range: -40 ... +260 °C [-40 ... +500 °F]

VFD: 0 ... 100 %

Indicates the current temperature at the corresponding additional sensor (without control function).

- S3 : Temperature at sensor 3
- S4 : Temperature at sensor 4
- VFD : Grundfos Direct Sensor™



Note

S3 and S4 will only be indicated if the temperature sensors are connected to the corresponding terminals. VFD will be indicated only if a Grundfos Direct Sensor™ has been connected and registered.

Display of further temperatures

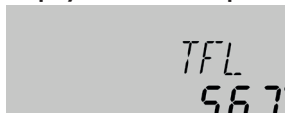

TFL, TR

Further measured temperatures

Display range: -40 ... +260 °C [-40 ... +500 °F]

Indicates the current temperature at the corresponding sensor. The display of these temperatures depends on the system selected.

- TFL : Temperature flow
- TR : Temperature return



Note

TFL/ TR will be indicated only if the heat quantity measurement option (OHQM) has been activated.

Display of flow rate

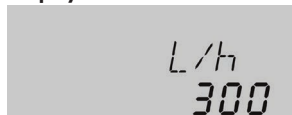

l/h

Flow rate

Display range: depending on the sensor type used

Indicates the current flow rate at the VFD flow rate sensor.

The display range depends on the sensor type previously selected.

Display of current pump speed

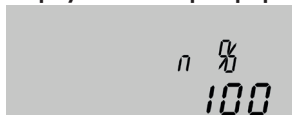

n %

Current pump speed

Display range: 30 ... 100 %

Indicates the current pump speed.



kWh/MWh

Heat quantity in kWh/MWh

Display channel

Indicates the energy gained in heat quantity – only available if heat quantity measurement (**OHQM**) is activated.

The heat quantity measurement can be carried out in 2 different ways (see page 33): with a fixed flow rate value or with a VFD Grundfos Direct Sensor™. It is shown in kWh in the channel **kWh** and in MWh in the channel **MWh**. The overall heat quantity results from the sum of both values.

The accumulated heat quantity can be set back to zero. As soon as one of the display channels of the heat quantity is selected, the symbol **SET** is displayed.

1. In order to access the reset mode of the counter, press button 3 for approx. 2 s.

SET starts flashing and the heat quantity value will be set back to zero.

2. In order to finish the reset process, press button 3.

In order to interrupt the reset process, do not press any button for about 5 s. The display returns to the display mode.



CDIS

Countdown monitoring period

Display range: 0 ... 30:0 ... 24 (dd:hh)

If the thermal disinfection option (**OTD**) is activated and the monitoring period is in progress, the remaining time is displayed as **CDIS** (in hours and minutes), counting backwards.

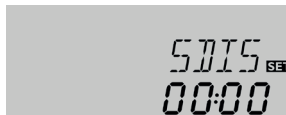

SDIS

Display of starting time

Display range: 00:00 ... 24:00 (hh:mm)

If the thermal disinfection option (**OTD**) is activated and a starting delay time has been adjusted, the adjusted starting time is displayed as **SDIS** (flashing).

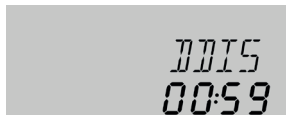

DDIS

Display of heating period

Display range: 00:00 ... 24:00 (hh:mm)

If the thermal disinfection option (**OTD**) is activated and the heating period is in progress, the remaining time is displayed as **CDIS** (in hours and minutes), counting backwards.

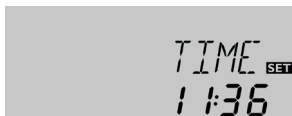

TIME

Indicates the current clock time.

1. In order to adjust the hours, press button 3 for approx. 2 s.
2. Set the hours by pressing buttons 1 and 2.
3. In order to adjust the minutes, press button 3.
4. Set the minutes by pressing buttons 1 and 2.
5. In order to save the adjustments, press button 3.

Operating hours counter

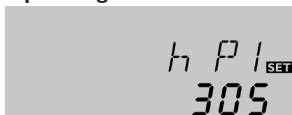

h P/h P1/h P2

Operating hours counter
Display channel

The operating hours counter accumulates the operating hours of the corresponding relay (**hP/h P1/h P2**). Full hours are displayed.

The accumulated operating hours can be set back to zero. As soon as an operating hours channel is selected, the symbol **SET** is displayed.

1. In order to access the reset mode of the counter, press button 3 for approx. 2 s. **SET** starts flashing and the operating hours will be set back to zero.

2. In order to finish the reset process, press button 3.

In order to interrupt the reset process, do not press any button for about 5 s. The display returns to the display mode.

6.2 Adjustment channels

System selection



Arr

System selection.

Adjustment range: 1 ... 3

Factory setting: 1

In this channel, a pre-defined system can be selected. Each system has a set of pre-programmed settings that can be individually changed.

If the system selection is changed later on, any previous adjustments which have been made in the other channels will be lost. Therefore, changing the system is always followed by a security enquiry.

Only confirm the security enquiry if you are sure that you wish to change the system selection.

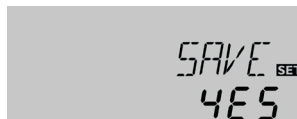

Security enquiry:

→ In order to confirm the security enquiry, press button 3.

ΔT control



DTO

Switch-on temperature difference
Adjustment range: 1.0 ... 20.0 K [2.0 ... 40.0 °Ra]
Factory setting: 6.0 K [12.0 °Ra]

The controller works as a standard differential controller. If the temperature reaches or exceeds the switch-on temperature difference, the pump switches on. When the temperature difference reaches or falls below the adjusted switch-off temperature difference, the respective relay switches off.



Note

The switch-on temperature difference must be at least 0.5 K [1 °Ra] higher than the switch-off temperature difference.

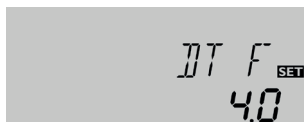

DTF

Switch-off temperature difference
Adjustment range: 0.5 ... 19.5 K [1.0 ... 39.0 °Ra]
Factory setting: 4.0 K [8.0 °Ra]



Note

If the drainback option **ODB** is activated, the values of the parameters **DTO**, **DTF** and **DTS** will be adapted to values suiting drainback systems:

DT O = 10 K [20 °Ra]

DT F = 4 K [8 °Ra]

DT S = 15 K [30 °Ra]

Adjustments that have been previously made in these channels will be overridden and have to be entered again if **ODB** is deactivated later on.

Speed control

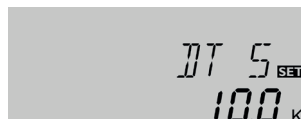

DTS

Set temperature difference
Adjustment range:
1.5 ... 30.0 K [3.0 ... 60.0 °Ra]
Factory setting: 10.0 K [20.0 °Ra]



Note

For pump speed control, the operating mode of the corresponding relay must be set to Auto (adjustment channel **MAN1**).

If the temperature difference reaches or exceeds the switch-on temperature difference, the pump switches on at 100% speed for 10 s. Then, the speed is reduced to the minimum pump speed value.

If the temperature difference reaches the adjusted set value, the pump speed increases by one step (10%). The response of the controller can be adapted via the parameter Rise. Each time the difference increases by the adjustable rise value, the pump speed increases by 10% until the maximum pump speed of 100% is reached. If the temperature difference decreases by the adjustable rise value, pump speed will be decreased by one step.



Note

The set temperature difference must be at least 0.5 K [1 °Ra] higher than the switch-on temperature difference.



RIS

Rise
Adjustment range:
1 ... 20 K [2 ... 40 °Ra]
Factory setting: 2 K [4 °Ra]



PUM

Pump control type

Selection: OnOF, PULS, PSOL, PHEA

Factory setting: PSOL

With this parameter, the pump control type can be adjusted. The following types can be selected:

Adjustment for standard pump without speed control

- OnOF (pump on/pump off)

Adjustment for standard pump with speed control

- PULS (burst control via semiconductor relay)

Adjustment for high-efficiency pump (HE pump)

- PSOL (PWM profile for a HE solar pump)
- PHEA (PWM profile for a HE heating pump)

Minimum speed

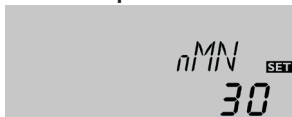

nMN

Minimum speed

Adjustment range: (10) 30 ... 100%

Factory setting: 30%

nMN, n1MN, if ODB is activated: 50%

In the adjustment channel **nMN**, a relative minimum pump speed for a pump connected can be allocated to the output R1.



Note

The pump speed must be set to 100% when auxiliary relays or valves are connected.

Maximum speed



nMX

Maximum speed

Adjustment range: (10) 30 ... 100%

Factory setting: 100%

In the adjustment channel **nMX**, a relative maximum speed for a pump connected can be allocated to the output R1.



Note

The pump speed must be set to 100% when auxiliary relays or valves are connected.

Maximum store temperature

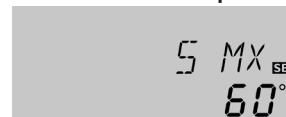

SMX

Maximum store temperature

Adjustment range: 4 ... 95 °C [40 ... 200 °F]

Arr 3: 4 ... 90 °C [40 ... 190 °F]

Factory setting: 60 °C [140 °F]

If the store temperature reaches the adjusted maximum temperature, the store will no longer be loaded in order to avoid damage caused by overheating. A non-adjustable hysteresis of 2 K [4 °Ra] is set for the maximum store temperature.

If the maximum store temperature is exceeded, ✱ is displayed.



Note

If the collector cooling or the system cooling function is activated, the adjusted maximum store temperature may be exceeded. In order to prevent system damage, the controller is also equipped with an integrated store emergency shutdown, deactivating the system if the store reaches 95 °C [200 °F].

Store emergency shutdown

OSEM

Store emergency shutdown option

Adjustment range: ON, OFF

Factory setting: OFF

This option is used for activating the internal store emergency shutdown for an upper store sensor. If the temperature at the reference sensor exceeds 95 °C, store 1 will be blocked and loading will be stopped until the temperature falls below 90 °C.



Note

Sensor S3 ist used as the reference sensor.

Collector limit temperature

Collector emergency shutdown

EM

Collector limit temperature

Adjustment range: 80 ... 200 °C [170 ... 390 °F]

Factory setting: 130 °C [270 °F]

When the collector temperature exceeds the adjusted collector limit temperature, the solar pump (R1/R2) switches off in order to protect the system components against overheating (collector emergency shutdown). If the collector limit temperature is exceeded, Δ is displayed.



Note

If the drainback option **ODB** is activated, the adjustment range of **EM** will change to 80 ... 120 °C [170 ... 250 °F]. The factory setting in that case is 95 °C [200 °F].

Cooling functions

In the following the 3 cooling functions – collector cooling, system cooling and store cooling – are described in detail. The following note is valid for all three cooling functions:



Note

The cooling functions will not become active as long as solar loading is possible.

Collector cooling

OCC

Collector cooling option

Adjustment range: OFF/ON

Factory setting: OFF

CMX

Collector maximum temperature

Adjustment range: 70 ... 160 °C [150 ... 320 °F]

Factory setting: 110 °C [230 °F]

The collector cooling function keeps the collector temperature within the operating range by heating the store. If the store temperature reaches 95 °C [200 °F] the function will switch off for safety reasons.

If the store temperature exceeds the adjusted maximum store temperature, the solar system is switched off. If the collector temperature increases to the adjusted maximum collector temperature, the solar pump is activated until the collector temperature falls below the maximum collector temperature. The store temperature may then exceed the maximum store temperature, but only up to 95 °C [200 °F] (emergency shutdown of the store).

If the collector cooling function is active, \odot and \star are displayed (flashing).

**Note**

This function will only be available if the system cooling function (**OSYC**) is deactivated.

**Note**

In system 3, the parameter **CMX** is available without the **OCC** function. In system 3, **CMX** is used for setting the activation temperature for the heat dump function. No other switch-on condition is needed in that case.

System cooling**OSYC**

System cooling option

Adjustment range: OFF/ON

Factory setting: OFF

**DTCD**

Switch-on temperature difference

Adjustment range:

1.0 ... 30.0 K [2.0 ... 60.0 °Ra]

Factory setting: 20.0 K [40.0 °Ra]

The system cooling function aims to keep the solar system operational for a longer time. The function overrides the maximum store temperature to provide thermal relief of the collector field and the heat transfer fluid on hot days. If the store temperature is higher than the adjusted maximum store temperature and the switch-on temperature difference **DTCD** is reached, the solar pump remains switched on or will be switched on. Solar loading is continued until either the temperature difference falls below the adjusted value **DTCF** or the collector limit temperature is reached. If the system cooling function is active, ☉ and ☼ are displayed (flashing).

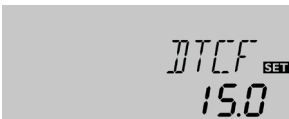
**DTCF**

Switch-off temperature difference

Adjustment range: 0.5 ... 29.5 K [1.0 ... 59.0 °Ra]

Factory setting: 15.0 K [30.0 °Ra]

**Note**

This function will only be available, if the collector cooling function (**OCC**) is deactivated.

Store cooling**OSTC**

Store cooling option

Adjustment range: OFF/ON

Factory setting: OFF

**THOL**

Holiday cooling temperature

Adjustment range: 20 ... 80 °C [70 ... 175 °F]

Factory setting: 40 °C [110 °F]

**OHOL**

Holiday cooling option

Adjustment range: OFF/ON

Factory setting: OFF

When the store cooling function is activated, the controller aims to cool down the store during the night in order to prepare it for solar loading on the following day. If the adjusted maximum store temperature (**SMX**) is exceeded and the collector temperature falls below the store temperature, the system will be reactivated in order to cool down the store. Cooling will continue until the store temperature has fallen below the adjusted maximum store temperature (**SMX**) again. A hysteresis of 2K [4 °Ra] is set for the store cooling function.

Reference threshold temperature differences for the store cooling function are **DTO** and **DTF**.

If no DHW consumption is expected for a longer period of time, the additional holiday cooling option **OHOL** can be activated in order to extend the store cooling function. The adjustable temperature **THOL** then replaces the maximum store temperature (**SMX**) as the switch-off temperature for the store cooling function. When the holiday cooling function is activated, ☼ and △ (flashing) are shown on the display.

If the holiday cooling function is active, ☉, ☼ and △ are displayed (flashing).

Collector minimum limitation

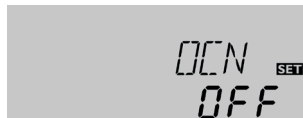

OCN

Collector minimum limitation option

Adjustment range: OFF/ON

Factory setting: OFF

If the collector minimum limitation option is activated, the pump (R1/R2) will only be switched on, if the adjustable collector minimum temperature is exceeded. The minimum temperature prevents the pump from being switched on too often at low collector temperatures. A hysteresis of 5K [10 °Ra] is set for this function. If the collector minimum limitation is active, ❄️ is displayed (flashing).



Note

If **OSTC** or **OCF** is active, the collector minimum limitation will be overridden. In that case, the collector temperature may fall below **CMN**.

Antifreeze function

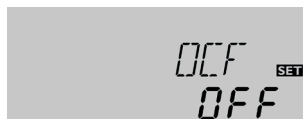

OCF

Antifreeze function option

Adjustment range: OFF/ON

Factory setting: OFF

The antifreeze function activates the loading circuit between the collector and the store when the temperature falls below the adjusted antifreeze temperature. This will protect the fluid against freezing or coagulating. If the adjusted antifreeze temperature is exceeded by 1K [2 °Ra], the loading circuit will be deactivated.

If the antifreeze function is activated, ❄️ is displayed. If the antifreeze function is active, ⓪ and ❄️ are displayed (flashing).



CMN

Minimum collector temperature

Adjustment range:

10.0... 90.0 °C [50.0... 190.0 °F]

Factory setting: 10.0 °C [50.0 °F]



Note

Since this function uses the limited heat quantity of the store, the antifreeze function should only be used in regions with few days of temperatures around the freezing point.

The antifreeze function will be suppressed if the store temperature falls below +5 °C [+40 °F] in order to protect the store from frost damage.

Tube collector function



OTC

Tube collector option

Adjustment range: OFF/ON

Factory setting: OFF

This function is used for improving the switch-on behaviour in systems with non-ideal sensor positions (e.g. with some tube collectors). This function operates within an adjusted time frame. It activates the collector circuit pump for an adjustable runtime between adjustable standstill intervals in order to compensate for the delayed temperature measurement.

If the runtime is set to more than 10 s, the pump will be run at 100% for the first 10 s of the runtime. For the remaining runtime, the pump will be run at the adjusted minimum speed. If the collector sensor is defective or the collector is blocked, this function is suppressed or switched off.



TCST

Tube collector function starting time

Adjustment range: 00:00... 23:45

Factory setting: 07:00

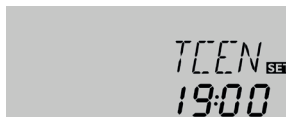

TCEN

Tube collector function ending time

Adjustment range: 00:00... 23:45

Factory setting: 19:00



TCRU

Tube collector function runtime

Adjustment range: 5... 500 s

Factory setting: 30 s



TCIN

Tube collector function standstill interval

Adjustment range: 1 ... 60 min

Factory setting: 30 min



Note

If the drainback option **ODB** is activated, **TRCU** will not be available. In that case, the runtime will be determined by the parameters **tFLL** and **tSTB**.

Grundfos Direct Sensor™ registration



GFD

Grundfos Direct Sensor™ registration

Selection: OFF, 12, 40, 40F

Factory setting: OFF

Registration of a digital flow rate sensor which can be used for heat quantity measurement.

OFF : no Grundfos Direct Sensor™

12 : VFD 1-12 (water-propylene glycol mixture only)

40 : VFD 2-40

40F : VFD 2-40 Fast (water only)

Heat quantity measurement



OHQM

Heat quantity measurement option

Adjustment range: OFF/ON

Factory setting: OFF

If **OHQM** is activated, the heat quantity gained can be calculated and displayed.

The heat quantity measurement can be carried out in 2 different ways (see below): with a fixed flow rate value or with a VFD Grundfos Direct Sensor™.

Heat quantity measurement with fixed flow rate value

The heat quantity balancing (estimation) uses the difference between the flow and return temperatures and the entered flow rate (at 100% pump speed).

1. Read the flow rate (l/min) and adjust it in the **FMAX** channel.
2. Adjust the antifreeze type and concentration of the heat transfer fluid in the channels **MEDT** and **MED%**.



Note

Heat quantity measurement is not possible in systems with 2 solar pumps.



FMAX

Flow rate in l/min

Adjustment range: 0.5 ... 100.0

Factory setting: 6.0



Note:

The **FMAX** channel will be available only if the **SEN** channel has been set to **OFF** or if no VFD Grundfos Direct Sensor™ is activated.

Heat quantity measurement with a VFD Grundfos Direct Sensor™

Heat quantity measurement with a VFD Grundfos Direct Sensor™ is possible in all system layouts.

In order to use a VFD Grundfos Direct Sensor™ for heat quantity measurement, proceed as follows:

1. Register the VFD Grundfos Direct Sensor™ in the **GFD** channel.
2. Adjust the position of the **VFD** Grundfos Direct Sensor™ in the **SEN** channel.
3. Adjust the type and concentration of the heat transfer fluid in the channels **MEDT** and **MED%**.



SEN

Digital flow rate sensor (only if SEN = 12, 40 or 40F)

Selection: OFF, 1, 2

Factory setting: 2

Flow rate detection type:

OFF : fixed flow rate value (flowmeter)

1 : Grundfos Direct Sensor™ in the flow pipe

2 : Grundfos Direct Sensor™ in the return pipe

Sensor allocation for heat quantity measurement:

SEN	1		2		OFF		
	Arr	SFL	SRET	SFL	SRET	SFL	SRET
1		GFD	S4	S4	GFD	S1	S4
2		GFD	S4	S4	GFD	S1	S4
3		GFD	S4	S4	GFD	S1	S4



MEDT

Heat transfer fluid

Adjustment range: 0 ... 3

Factory setting: 1

Heat transfer fluid:

0 : Water

1 : Propylene glycol

2 : Ethylene glycol

3 : Tyfocor® LS/G-LS



Note

If the system 3 has been selected and **OHQM** is activated, heat quantity measurement will be interrupted when the 3-port valve switches to the heat dump. Heat quantity measurement with a VFD Grundfos Direct Sensor™ will continue independently.



MED%

Antifreeze concentration

in Vol-% (MED% is not indicated when MEDT 0 or 3 is used.)

Adjustment range: 20 ... 70%

Factory setting: 45%

Drainback option



Note

A drainback system requires additional components such as a holding tank. The drainback option should only be activated if all components required are properly installed.



Note

The drainback option is only available in systems 1 and 2.

In a drainback system the heat transfer fluid will flow into a holding tank if solar loading does not take place. The drainback option initiates the filling process if solar loading is about to start. If the drainback option is activated, the following adjustment can be made.



ODB

Drainback option

Adjustment range: OFF/ON

Factory setting: OFF



Note

If the drainback option is activated, the cooling functions and the antifreeze function will not be available. If one or more than one of these functions have been activated before, they will be deactivated again as soon as **ODB** is activated. They will remain deactivated, even if **ODB** is deactivated later on.



Note

If the drainback option **ODB** is activated, the factory settings of the parameters **nMN**, **DTO**, **DTF** and **DTS** will be adapted to values suiting drainback systems:

Additionally, the adjustment range and the factory setting of the collector emergency shutdown will change. Adjustments previously made in these channels will be overridden and have to be entered again if the drainback option is deactivated later on.

Time period – switch-on condition

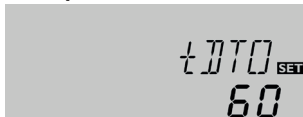

tD70

Time period – switch-on condition

Adjustment range: 1 ... 100 s

Factory setting: 60 s

The parameter **tD70** is used for adjusting the time period during which the switch-on condition must be permanently fulfilled.

Filling time

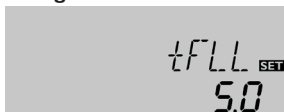

tFLL

Filling time

Adjustment range: 1.0 ... 30.0 min

Factory setting: 5.0 min

The parameter **tFLL** is used for adjusting the filling time. During this period, the pump runs at 100% speed.

Stabilisation

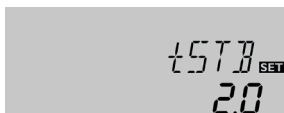

tSTB

Stabilisation

Adjustment range: 1.0 ... 15.0 min

Factory setting: 2.0 min

The parameter **tSTB** is used for adjusting the time period during which the switch-off condition will be ignored after the filling time has ended.

Booster function



OBST

Booster function

Adjustment range: ON/OFF

Factory setting: OFF

This function is used for switching on a second pump when filling the solar system. When solar loading starts, R2 is energised in parallel to R1. After the filling time has elapsed, R2 switches off.



Note

The booster function is available in system 1 only. The booster function will only be available if the drainback option has been activated.

Operating mode



MAN1/MAN2

Operating mode

Adjustment range: OFF, Auto, On

Factory setting: Auto

For control and service work, the operating mode of the relays can be manually adjusted. For this purpose, select the adjustment value **MAN1** (for R1) or **MAN2** (for R2) in which the following adjustments can be made:

• MAN1/MAN2

Operating mode

OFF : Relay off Δ (flashing) + ☞

Auto : Relay in automatic operation

ON : Relay on Δ (flashing) + ☞ + ⓪ / ⓪



Note

Always adjust the operating mode back to **Auto** when the control and service work is completed. Normal operation is not possible in manual mode.

Language

The LCD display shows the word 'LANG' in a large, stylized font with 'SET' in a smaller font to its right. Below it, the letter 'E' is displayed, and below that, the letters 'En' are displayed.

LANG

Language selection

Selection: dE, En, Fr, ES, It

Factory setting: dE

In this adjustment channel the menu language can be selected.

- dE : German
- En : English
- Fr : French
- ES : Spanish
- It : Italian

Unit

The LCD display shows the word 'UNIT' in a large, stylized font with 'SET' in a smaller font to its right. Below it, the symbol '°C' is displayed.

UNIT

Temperature unit selection

Selection: °F, °C

Factory setting: °C

In this adjustment channel, the display unit for temperatures and temperature differences can be selected. The unit can be switched between °C/K and °F/°Ra during operation.

Temperatures and temperature differences in °F and °Ra are displayed without units. If the indication is set to °C, the units are displayed with the values.

Reset

The LCD display shows the word 'RESE' in a large, stylized font with 'SET' in a smaller font to its right.

RESE

Reset function

By means of the reset function, all adjustments can be set back to their factory settings.

➔ In order to carry out a reset, press button 3

All adjustments that have previously been made will be lost! For this reason, a security enquiry will appear after the reset function has been selected.

Only confirm the security enquiry if you are sure you want to set back all adjustment to the factory setting.

The LCD display shows the word 'SAVE' in a large, stylized font with 'SET' in a smaller font to its right. Below it, the letters 'YES' are displayed.

Security enquiry

➔ In order to confirm the security enquiry, press button 3





Note

After a reset, the commissioning menu will start again (see page 22).

7 Troubleshooting

If a malfunction occurs, the display symbols will indicate an error code:

The symbol  is indicated on the display and the symbol  is flashing.

Sensor fault. An error code instead of a temperature is shown on the sensor display channel.

888.8

- 88.8

Cable is broken. Check the cable.

Short circuit. Check the cable.

Disconnected Pt1000 temperature sensors can be checked with an ohmmeter. Please check the resistance values correspond with the table.

°C	°F	Ω	°C	°F	Ω
-10	14	961	55	131	1213
-5	23	980	60	140	1232
0	32	1000	65	149	1252
5	41	1019	70	158	1271
10	50	1039	75	167	1290
15	59	1058	80	176	1309
20	68	1078	85	185	1328
25	77	1097	90	194	1347
30	86	1117	95	203	1366
35	95	1136	100	212	1385
40	104	1155	105	221	1404
45	113	1175	110	230	1423
50	122	1194	115	239	1442

Resistance values of Pt1000 sensors

WARNING! Electric shock!



Upon opening the housing, live parts are exposed!

→ Always disconnect the device from power supply before opening the housing!

The display is permanently off.

If the display is off, check the power supply of the controller. Is it disconnected?

no

yes

The fuse of the controller could be blown. The fuse holder (which holds the spare fuse) becomes accessible when the cover is removed. The fuse can then be replaced.

Check the supply line and reconnect it.

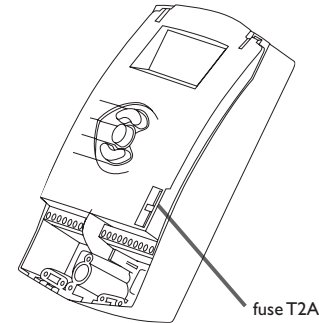

fuse T2A

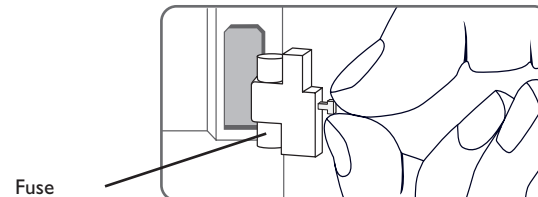

Fuse

Pump is overheated, but no heat transfer from the collector to the store, flow and return have the same temperature; perhaps also bubbling in the lines.

Air or gas bubbles in the system?

no yes

Vent the system; increase the system pressure to a static primary pressure of at least plus 0.5 bar; if necessary continue to increase pressure; switch the pump on and off for a short time.

Is the collector circuit blocked at the dirt trap?

yes

Clean dirt trap

Pump starts up very late.

Switch-on temperature difference ΔT_{on} too large?

no yes

Change ΔT_{on} and ΔT_{off} correspondingly.

Non-ideal position of the collector sensor (e. g. flatscrew sensor instead of sensor in immersion sleeves).

yes

Activate tube collector function if necessary.

o.k.

Pump starts for a short moment, switches off, switches on again, etc.

Temperature difference at the controller too small?

no yes

Change ΔT_{on} and ΔT_{off} correspondingly.

no o.k.

Wrong position of collector sensors?

no yes

Mount the collector sensor at solar flow (warmest collector output); use immersion sleeve of the respective collector.

Plausibility control of the option tube collector special function

The temperature difference between store and collector increases enormously during operation; the collector circuit cannot dissipate the heat.

Collector circuit pump defective?

no yes

Check/replace it

Heat exchanger calcified?

no yes

Decalcify it

Heat exchanger blocked?

no yes

Clean it

Heat exchanger too small?!

yes

Replace with correctly sized one.



Note: For answers to frequently asked questions (FAQ) see www.resol.com.

Store cool down at night

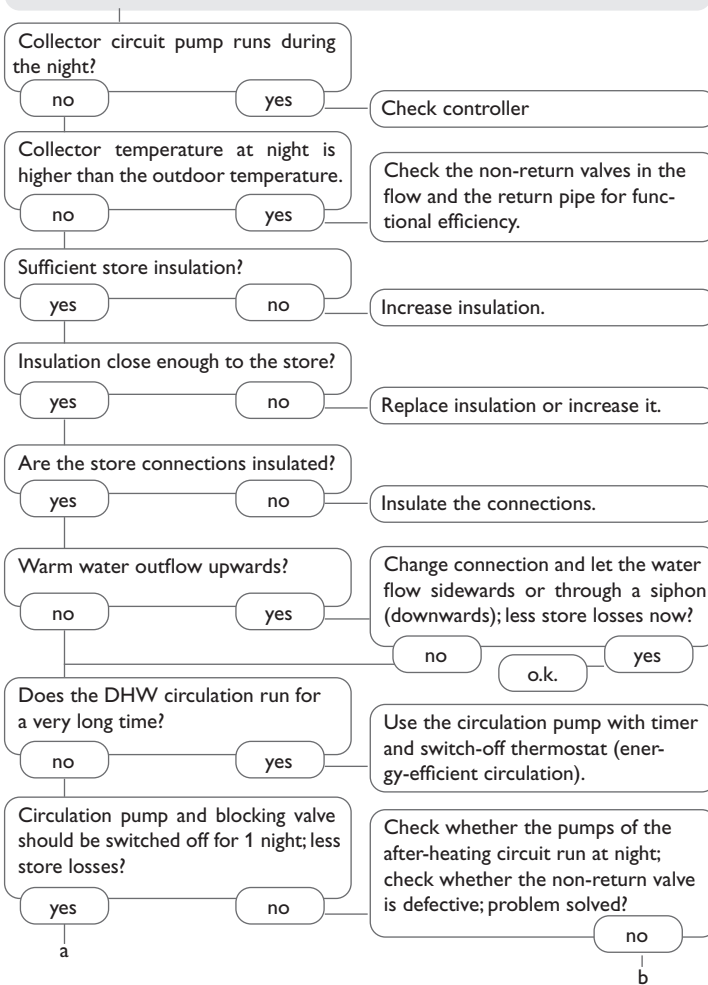

a

b

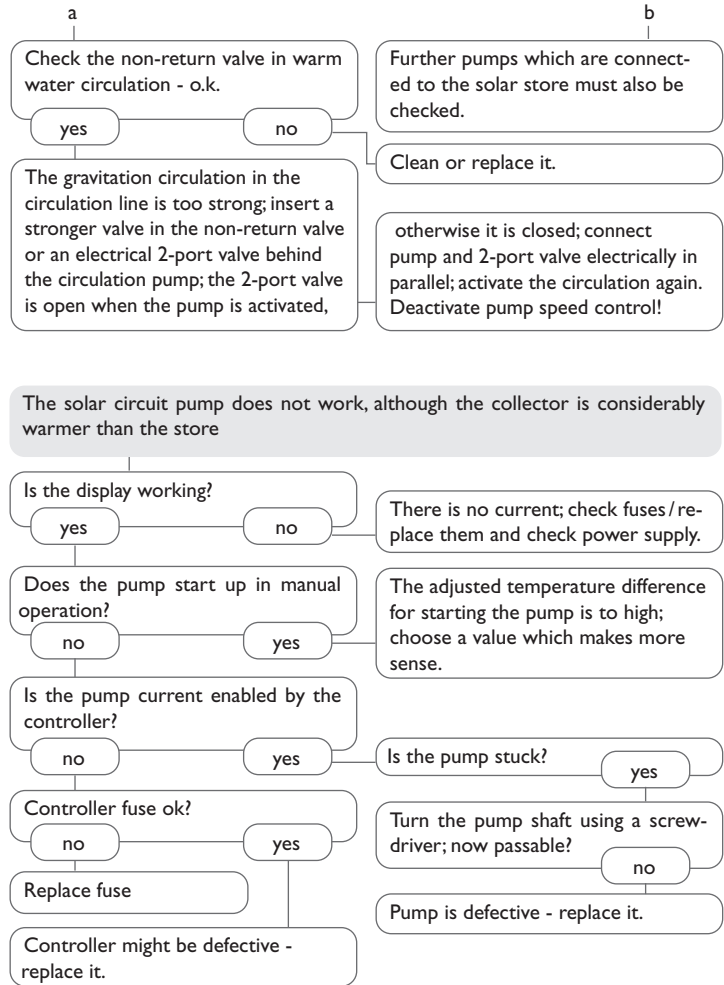

a

b

The solar circuit pump does not work, although the collector is considerably warmer than the store

en

Installation

Operation and function

Commissioning

Indications, functions and options

Messages

Symbole	
ΔT control	27
A	
Accessories.....	39, 40
Antifreeze function	31
B	
Backup heating.....	14
Booster function	34
C	
Collector cooling	29
Collector emergency shutdown.....	29
Commissioning	21
Cooling function.....	29
D	
Data communication / Bus.....	7
Displays.....	19
Drainback option	33
E	
Electrical connection.....	6
F	
Flow rate.....	25, 32
H	
Heat quantity measurement.....	32
Holiday.....	30
L	
Language.....	35
M	
Minimum collector temperature	31
Monitoring-Display	19
Mounting	5
O	
Operating mode.....	34
S	
Speed control.....	27
Store cooling.....	30
System overview	7
System screen	20
T	
Technical data.....	4
Thermal disinfection.....	15
Thermostat function	14
Time.....	21
Troubleshooting.....	36

Software License Information (Firmware Version 3.00)

Copyright 2020 (c) Raspberry Pi (Trading) Ltd.

Redistribution and use in source and binary forms, with or without modification, are permitted provided that the following conditions are met:

1. Redistributions of source code must retain the above copyright notice, this list of conditions and the following disclaimer.
2. Redistributions in binary form must reproduce the above copyright notice, this list of conditions and the following disclaimer in the documentation and/or other materials provided with the distribution.
3. Neither the name of the copyright holder nor the names of its contributors may be used to endorse or promote products derived from this software without specific prior written permission.

THIS SOFTWARE IS PROVIDED BY THE COPYRIGHT HOLDERS AND CONTRIBUTORS "AS IS" AND ANY EXPRESS OR IMPLIED WARRANTIES, INCLUDING, BUT NOT LIMITED TO, THE IMPLIED WARRANTIES OF MERCHANTABILITY AND FITNESS FOR A PARTICULAR PURPOSE ARE DISCLAIMED. IN NO EVENT SHALL THE COPYRIGHT HOLDER OR CONTRIBUTORS BE LIABLE FOR ANY DIRECT, INDIRECT, INCIDENTAL, SPECIAL, EXEMPLARY, OR CONSEQUENTIAL DAMAGES (INCLUDING, BUT NOT LIMITED TO, PROCUREMENT OF SUBSTITUTE GOODS OR SERVICES; LOSS OF USE, DATA, OR PROFITS; OR BUSINESS INTERRUPTION) HOWEVER CAUSED AND ON ANY THEORY OF LIABILITY, WHETHER IN CONTRACT, STRICT LIABILITY, OR TORT (INCLUDING NEGLIGENCE OR OTHERWISE) ARISING IN ANY WAY OUT OF THE USE OF THIS SOFTWARE, EVEN IF ADVISED OF THE POSSIBILITY OF SUCH DAMAGE.



Optionales Zubehör | Optional accessories | Accessoires optionnels | Accesorios opcionales | Accessori opzionali:
www.resol.de/4you

Distributed by:

RESOL – Elektronische Regelungen GmbH

Heiskampstraße 10
45527 Hattingen / Germany

Tel.: +49 (0) 23 24 / 96 48 - 0

Fax: +49 (0) 23 24 / 96 48 - 755

www.resol.com
info@resol.com

Important note

The texts and drawings in this manual are correct to the best of our knowledge. As faults can never be excluded, please note:

Your own calculations and plans, under consideration of the current standards and directions should only be basis for your projects. We do not offer a guarantee for the completeness of the drawings and texts of this manual - they only represent some examples. They can only be used at your own risk. No liability is assumed for incorrect, incomplete or false information and / or the resulting damages.

Note

The design and the specifications can be changed without notice.

The illustrations may differ from the original product.

Imprint

This mounting- and operation manual including all parts is copyrighted. Another use outside the copyright requires the approval of **RESOL – Elektronische Regelungen GmbH**. This especially applies for copies, translations, micro films and the storage into electronic systems.

© **RESOL – Elektronische Regelungen GmbH**