

DeltaTherm® HT

RESOL®

beginning with version 1.0

Heating circuit controller for heat interface units

Manual for the
specialised craftsman

Mounting

Connection

Operation

Troubleshooting

Application examples

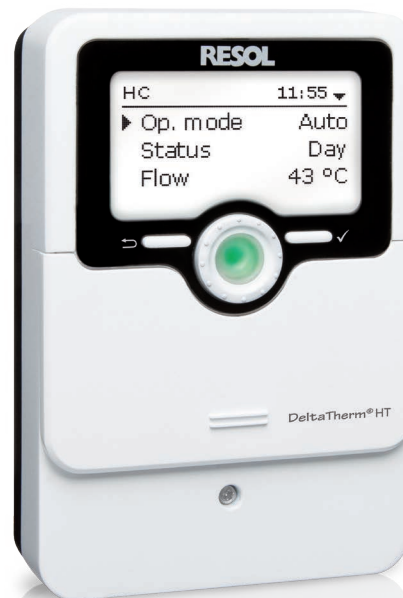

11212709

Thank you for buying this RESOL product.

Please read this manual carefully to get the best performance from this unit. Please keep this manual carefully.

en

Manual

www.resol.com

Safety advice

Please pay attention to the following safety advice in order to avoid danger and damage to people and property.

Danger of electric shock:

- When carrying out works, the device must first of all be disconnected from the mains.
- It must be possible to disconnect the device from the mains at any time.
- Do not use the device if it is visibly damaged.

The device must not be used by children or persons with reduced physical, sensory or mental abilities or without any experience and knowledge. Make sure that children do not play with the device!

Only connect accessories authorised by the manufacturer to the device.

Make sure that the housing is properly closed before commissioning the device.

Set the code to the customer code before handing over the controller to the customer.

Target group

These instructions are exclusively addressed to authorised skilled personnel.

Only qualified electricians are allowed to carry out electrical works.

Initial commissioning must be effected by authorised skilled personnel.

Authorised skilled personnel are persons who have theoretical knowledge and experience with the installation, commissioning, operation, maintenance, etc. of electric/electronic devices and hydraulic systems and who have knowledge of relevant standards and directives.

Instructions

Attention must be paid to the valid local standards, regulations and directives!

Subject to technical change. Errors excepted.

Information about the product

Proper usage

The controller is designed for use in heating systems in compliance with the technical data specified in this manual.

Any use beyond this is considered improper.

Proper usage also includes compliance with the specifications given in this manual.

Improper use excludes all liability claims.



Note:

Strong electromagnetic fields can impair the function of the device.

- ➔ Make sure the device as well as the system are not exposed to strong electromagnetic fields.

EU Declaration of conformity

The product complies with the relevant directives and is therefore labelled with the CE mark. The Declaration of Conformity is available upon request, please contact the manufacturer.



Scope of delivery

The scope of delivery of this product is indicated on the packaging label.

Storage and transport

Store the product at an ambient temperature of 0 ... 40 °C and in dry interior rooms only.

Transport the product in its original packaging only.

Cleaning

Clean the product with a dry cloth. Do not use aggressive cleaning fluids.

Data security

We recommend regular backups of the data stored on the device via MicroSD card.

Decommissioning

1. Disconnect the device from the power supply.
2. Dismount the device.

Disposal

- Dispose of the packaging in an environmentally sound manner.
- At the end of its working life, the product must not be disposed of as urban waste. Old appliances must be disposed of by an authorised body in an environmentally sound manner. Upon request we will take back your old appliances bought from us and guarantee an environmentally sound disposal of the devices.



Description of symbols

Warnings are indicated with a warning symbol!

Signal words describe the danger that may occur, when it is not avoided.

WARNING means that **injury, possibly life-threatening injury, can occur.**

→ It is indicated how to avoid the danger described.



ATTENTION means that **damage to the appliance can occur.**

→ It is indicated how to avoid the danger described.



Note

Notes are indicated with an information symbol.

→ Texts marked with an arrow indicate one single instruction step to be carried out.

1. Texts marked with numbers indicate several successive instruction steps to be carried out.

The controller offers a compact and user-friendly solution for simple heating systems. It can control a weather-compensated heating circuit. Additionally, there's a choice of 5 different operating modes and a night correction. Due to the commis-

sioning menu, configuration is quick and easy. The chimney sweeper function and the holiday mode can be activated by pressing a single button.

Contents

1	Overview	5	6	Heating	18
2	Installation	6	6.1	Screed drying.....	22
2.1	Mounting.....	6	7	Basic settings	24
2.2	Electrical connection.....	6	8	SD card	24
2.3	Data communication / Bus.....	7	9	Manual mode	25
2.4	MicroSD card slot.....	7	10	User code	26
3	Operation and function	8	11	Troubleshooting	26
3.1	Buttons and adjustment dial.....	8	12	Accessories	29
3.2	Microbutton for chimney sweeper function / screed drying and holiday mode.....	8	12.1	Sensors and measuring instruments.....	30
3.3	Control lamp	8	13	Index	31
4	Commissioning	13			
4.1	Basic settings.....	15			
5	Functions and options	16			
5.1	Menu structure.....	16			
5.2	Status menu.....	17			
5.3	Heating.....	17			
5.4	Meas./ Balance values	17			
5.5	Messages	17			

1 Overview

- Pre-configured basic system
- 4 relay outputs (incl. 1 extra-low voltage relay)
- 4 inputs for Pt1000 temperature sensors
- 5 operating modes, room thermostat and night correction
- Holiday mode, chimney sweeper function and screed drying function via microbuttons
- Data logging, storing, easy transfer of controller adjustments prepared and firmware updates via SD card
- Weather-compensated control with room influence or demand-based room control with 1 room temperature sensor
- Remote access with a room control unit
- Function for using a central outdoor sensor unit

Dimensions and minimum distances

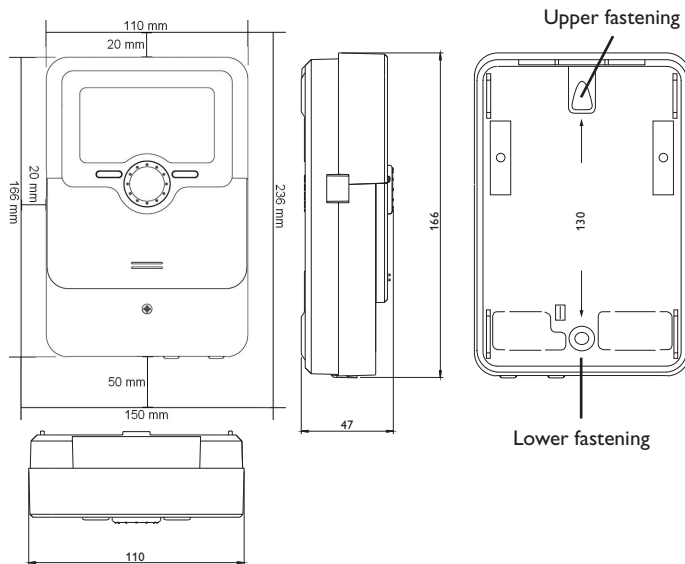

Technical data

Inputs: 4 inputs for Pt1000 temperature sensors (1 of them can be converted to room thermostat (switch)), 1 input for remote control (RTA) or operating mode switch (BAS)

Outputs: 3 semiconductor relays, 1 potential-free extra-low voltage relay, 1 PWM output, 1 0-10 V output

PWM frequency: 512 Hz

PWM voltage: 10.8 V

Switching capacity:

1 (1) A 240 V~ (semiconductor relay)

1 (1) A 30 V=== (potential-free relay)

Total switching capacity: 3 A 240 V~

Power supply: 100–240 V~ (50–60 Hz)

Supply connection: type X attachment

Standby: 0.63 W

Mode of operation: type 1.B.C.Y action

Rated impulse voltage: 2.5 kV

Data interface: VBus®, MicroSD card slot

Functions: weather-compensated heating circuit control, room thermostat, chimney sweeper function, screed drying function, holiday mode

Housing: plastic, PC-ABS and PMMA

Mounting: wall mounting, also suitable for mounting into patch panels

Indication / Display: full graphic display, operating control LED (Lightwheel®)

Operation: 4 buttons and 1 adjustment dial (Lightwheel®)

Protection type: IP 20 / DIN EN 60529

Protection class: I

Ambient temperature: 0... 40 °C

Degree of pollution: 2

Fuse: T4A

Maximum altitude: 2000 m above MSL

Dimensions: 110 x 166 x 47 mm

2 Installation

2.1 Mounting

WARNING! Electric shock!



Upon opening the housing, live parts are exposed!

→ **Always disconnect the controller from power supply before opening the housing!**



Note:

Strong electromagnetic fields can impair the function of the device.

→ Make sure the device as well as the system are not exposed to strong electromagnetic fields.

The unit must only be located in dry interior rooms.

If the device is not equipped with a mains connection cable and a plug, the device must additionally be supplied from a double pole switch with contact gap of at least 3 mm or must be equipped with a disconnecting device (fuse) in accordance with the required installation regulations.

Please pay attention to separate routing of sensor cables and mains cables.

In order to mount the device to the wall, carry out the following steps:

1. Unscrew the crosshead screw from the cover and remove it along with the cover from the housing.
2. Mark the upper fastening point on the wall. Drill and fasten the enclosed wall plug and screw leaving the head protruding.
3. Hang the housing from the upper fastening point and mark the lower fastening point (centres 130 mm).
4. Insert lower wall plug.
5. Fasten the housing to the wall with the lower fastening screw and tighten.
6. Carry out the electrical wiring in accordance with the terminal allocation (see page 6).
7. Put the cover on the housing.
8. Attach with the fastening screw.

2.2 Electrical connection

WARNING! Electric shock!



Upon opening the housing, live parts are exposed!

→ **Always disconnect the controller from power supply before opening the housing!**

ATTENTION! ESD damage!



Electrostatic discharge can lead to damage to electronic components!

→ **Take care to discharge properly before touching the inside of the device! To do so, touch a grounded surface such as a radiator or tap!**



Note:

Connecting the device to the power supply must always be the last step of the installation!



Note:

The pump speed must be set to 100% when auxiliary relays or valves are connected.



Note:

It must be possible to disconnect the device from the mains at any time.

→ Install the mains plug such that it is accessible at any time.

→ If this is not possible, install a switch that can be accessed.

If the mains cable is damaged, it must be replaced by a special connection cable which is available from the manufacturer or its customer service.

Do not use the device if it is visibly damaged!

Depending on the product version, cables are already connected to the device. If that is not the case, please proceed as follows:

Terminal screws must be torqued to 0.5 Nm.

Attach flexible cables to the housing with the enclosed strain relief and the corresponding screws.

The controller is equipped with 4 **relays** in total to which loads such as pumps, valves, etc. can be connected:

Relays 1 ... 3 are semiconductor relays, designed for pump speed control:

Conductor R1 ... R3

Neutral conductor N (common terminal block)

Protective earth conductor \oplus (common terminal block)

Relay 4 is a potential-free extra-low voltage relay:

Connections to the R4 terminals can be made with either polarity.

Connect the **temperature sensors** (S1 to S4) to the terminals S1 ... S4 and GND (either polarity).

The cables carry low voltage and must not run together in a cable conduit with cables carrying a voltage higher than 50 V (please pay attention to the valid local regulations). The cable lengths depend on the cross sectional area.

Example: up to 100 m at 1.5 mm², up to 50 m at 0.75 mm². The cables can be extended with a two-wire cable.

The terminals marked **PWM/0-10V** are control outputs for high-efficiency pumps.

The controller is supplied with power via a mains cable. The power supply of the device must be 100–240 V~ (50–60 Hz).

The **mains connection** is at the terminals:

Neutral conductor N

Conductor L

Protective earth conductor ⊕ (common terminal block)

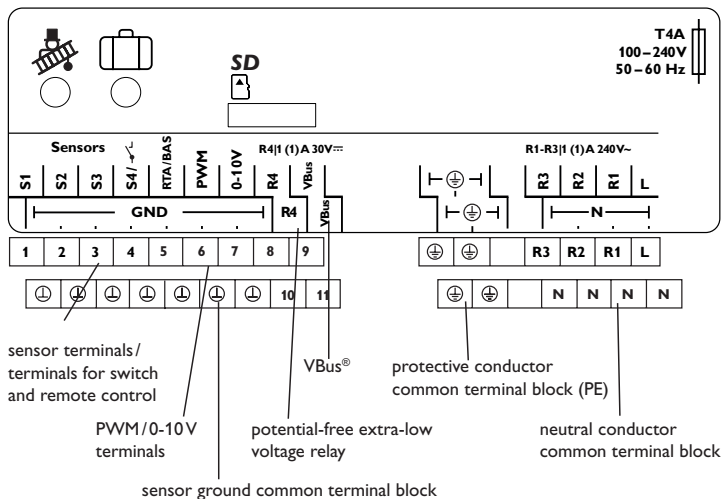

Note

For more details about the commissioning procedure see page 13.

2.3 Data communication / Bus

If a **central outdoor sensor unit** is used, connect it to the terminals marked **VBus** with correct polarity.



Note

More accessories on page 29.

2.4 MicroSD card slot

The controller is equipped with a MicroSD card slot.

With a MicroSD card, the following functions can be carried out:

- Store measurement and balance values onto the MicroSD card. After the transfer to a computer, the values can be opened and visualised, e.g. in a spreadsheet.
- Prepare adjustments and parameterisations on a computer and transfer them via the MicroSD card.
- Store adjustments and parameterisations on the MicroSD card and, if necessary, retrieve them from there.
- Download firmware updates from the Internet and install them on the controller via MicroSD card.

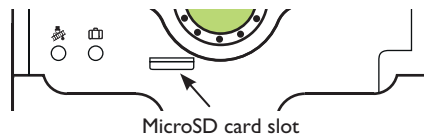

Note

For more information about using a MicroSD card, see page 24.

3 Operation and function

3.1 Buttons and adjustment dial

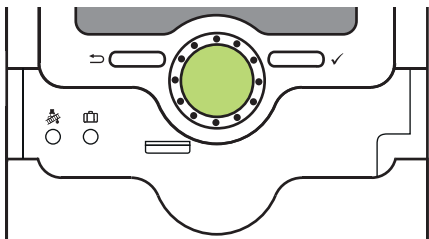

The controller is operated via 2 buttons and 1 adjustment dial (Lightwheel®) below the display:



Left button (←) - escape button for changing into the previous menu/changing to the home screen (Status Heating circuit), if the button is pressed for 2s



Right button (✓) - confirming/selecting

Lightwheel® - scrolling upwards/scrolling downwards, increasing adjustment values/reducing adjustment values

3.2 Microbutton for chimney sweeper function/screed drying and holiday mode





The controller is equipped with two microbuttons for quick access to the holiday mode and the chimney sweeper function/screed drying. The microbuttons are located underneath the slidable housing cover, the slider.

Microbutton : The chimney sweeper or screed drying function can be triggered with the microbutton . The chimney sweeper function is activated by default. In order to activate the screed drying function, the chimney sweeper function must be deactivated (see page 21). In order to trigger the chimney sweeper or screed drying function, press and hold down the microbutton  for 5s.

Microbutton : The microbutton  is used for activating the holiday mode. If the microbutton is pressed and held down for approx. 3 s, the adjustment channel **Days of absence** appears, allowing to enter the number of days for an absence. If the parameter is set to a value higher than 0, the holiday mode becomes active and the days will be counted backwards at 00:00. If the value is set to 0, the holiday mode is deactivated.

3.3 Control lamp

The controller is equipped with a multicolour LED in the centre of the Lightwheel®, indicating the following states:

Colour	Permanently shown	Flashing
	Everything OK	Manual mode on
	Screed drying cancelled	Sensor line break, sensor short circuit, initialisation
	Holiday mode active	Chimney sweeper function/screed drying active
		Manual mode off

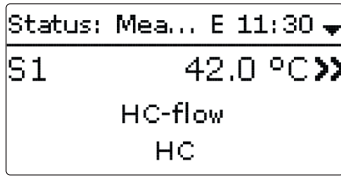

If the symbol **»** is shown behind a menu item, pressing the right button (✓) will open a new submenu.

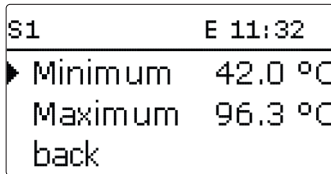

Values and adjustments can be changed in different ways:

Numeric values can be adjusted by means of a slide bar. The minimum value is indicated to the left, the maximum value to the right. The large number above the slide bar indicates the current adjustment. By turning the Lightwheel®, the upper slide bar can be moved to the left or to the right.

Only after the adjustment has been confirmed by pressing the right button (✓) will the number below the slide bar indicate the new value. The new value will be saved if it is confirmed by pressing the right button (✓) again.

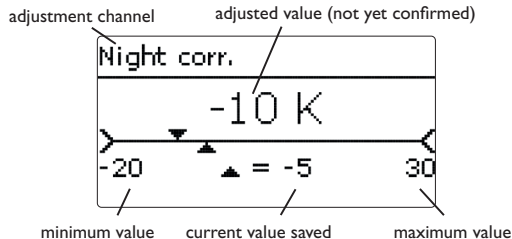

When 2 values are locked against each other, they will display a reduced adjustment range depending on the adjustment of the respective other value.

In this case, the active area of the slide bar is shortened, the inactive area is indicated as a dotted line. The indication of the minimum and maximum values will adapt to the reduction.

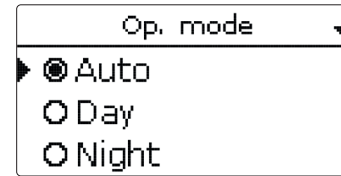

If only one item of several can be selected, they will be indicated with radio buttons. When one item has been selected, the radio button in front of it is filled.

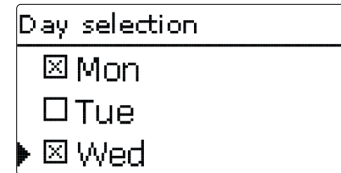

If more than one item of several can be selected, they will be indicated with checkboxes. When an item has been selected, an x appears inside the checkbox.

If no button has been pressed within a couple of minutes, the adjustment is cancelled and the previous value is retained.

Adjusting the timer

When the **Timer** option is activated, a timer is indicated in which time frames for the function can be adjusted.

In the **Day selection** channel, the days of the week are available individually and as frequently selected combinations.

If more than one day or combination is selected, they will be merged into one combination for the following steps.

The last menu item after the list of days is **Continue**. If **Continue** is selected, the **Edit timer** menu opens, in which the time frames can be adjusted.

Adding a time frame:

In order to add a time frame, proceed as follows:

1. Select **New time frame**.

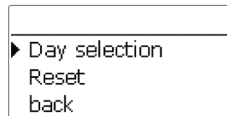

Day selection
Reset
back

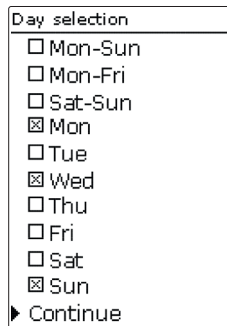

Day selection
 Mon-Sun
 Mon-Fri
 Sat-Sun
 Mon
 Tue
 Wed
 Thu
 Fri
 Sat
 Sun
▶ Continue

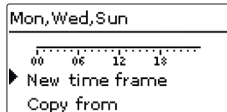

Mon, Wed, Sun
00 06 12 18
▶ New time frame
Copy from

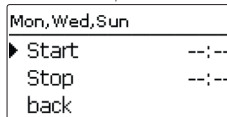

Mon, Wed, Sun
▶ Start --:--
Stop --:--
back

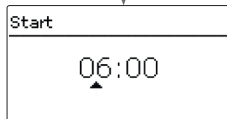

Start
06:00

2. Adjust **Start** and **Stop** for the desired time frame.

The time frames can be adjusted in steps of 5 min.

3. In order to save the time frame, select **Save** and confirm the safety enquiry with **Yes**.

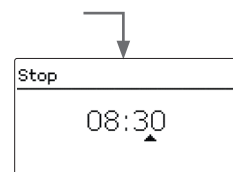

Stop
08:30

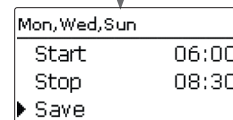

Mon, Wed, Sun
Start 06:00
Stop 08:30
▶ Save

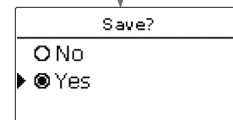

Save?
 No
▶ Yes

4. In order to add another time frame, repeat the previous steps.

6 time frames can be adjusted per day or combination.

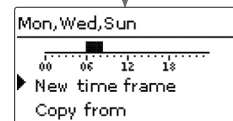

Mon, Wed, Sun
00 06 12 18
▶ New time frame
Copy from

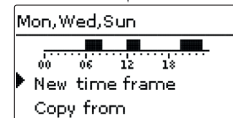

Mon, Wed, Sun
00 06 12 18
▶ New time frame
Copy from

5. Press the left button in order to get back to the day selection.

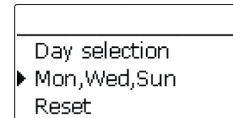

Day selection
▶ Mon, Wed, Sun
Reset

Copying a time frame:

In order to copy time frames already adjusted into another day/another combination, proceed as follows:

1. Choose the day/The combination into which the time frames are to be copied and select **Copy from**.

A selection of days and/or combinations with time frames will appear:

2. Select the day or combination from which the time frames are to be copied.

All time frames adjusted for the selected day or combination will be copied.

If the time frames copied are not changed, the day or combination will be added to the combination from which the time frames have been copied.

If the time frames copied are changed, the day/combination will be listed separately.

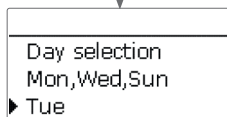
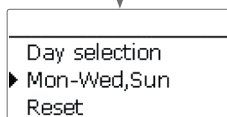
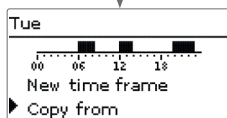
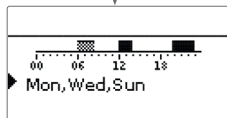
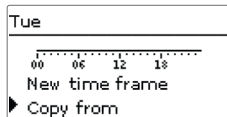

Changing a time frame:

In order to change a time frame, proceed as follows:

1. Select the time frame to be changed.

2. Make the desired change.

3. In order to save the time frame, select **Save** and confirm the safety enquiry with **Yes**.

Removing a time frame:

In order to delete a time frame, proceed as follows:

1. Select the time frame that is to be deleted.

2. Select **Delete** and confirm the safety enquiry with **Yes**.

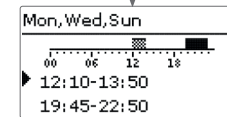
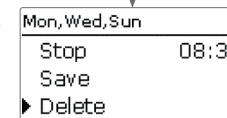
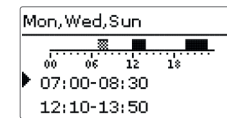
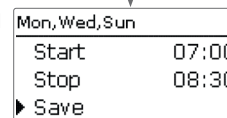
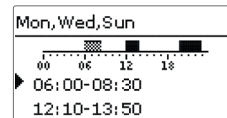

Resetting the timer:

In order to reset time frames adjusted for a certain day or combination, proceed as follows:

1. Select the desired day or combination.

Day selection
▶ Mon,Wed,Sun
Tue

Tue
00 06 12 18
New time frame
▶ Copy from

Reset
Reset? Yes

Day selection
Tue
Reset

2. **Select Reset** and confirm the safety enquiry with **Yes**.

The selected day or combination will disappear from the list, all its time frames will be deleted.

In order to reset the whole timer, proceed as follows:

- Select **Reset** and confirm the safety enquiry with **Yes**.

All adjustments made for the timer are deleted.

Mon,Wed,Sun
Tue
▶ Reset

Reset
Reset? Yes

Day selection
▶ Reset
back

4 Commissioning

When the hydraulic system is filled and ready for operation, connect the controller to the mains.

The controller runs an initialisation phase in which the Lightwheel® flashes red.

When the controller is commissioned or when it is reset, it will run a commissioning menu after the initialisation phase. The commissioning menu leads the user through the most important adjustment channels needed for operating the system.

Disconnecting the controller from the power supply after having run the commissioning menu will not delete adjustments that have already been carried out. After you switch on the device again, the controller will not start the commissioning menu, but normal operation after the initialisation phase.

Commissioning menu

The commissioning menu consists of the channels described in the following. In order to make an adjustment, adjust the desired value with the Lightwheel® and confirm with the right button (✓). The next channel will appear in the display.

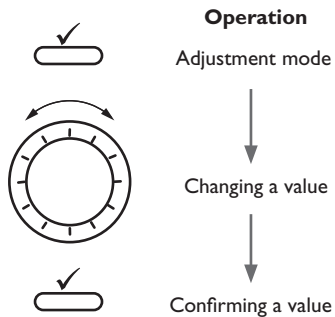

1. Language:

→ Adjust the desired menu language.

2. Daylight savings time adjustment:

→ Activate or deactivate the automatic daylight savings time adjustment.

3. Time:

→ Adjust the clock time. First of all adjust the hours, then the minutes.

4. Date:

→ Adjust the date. First of all adjust the year, then the month and then the day.

5. Central outdoor sensor unit

→ Activate or deactivate respectively the central outdoor sensor unit.

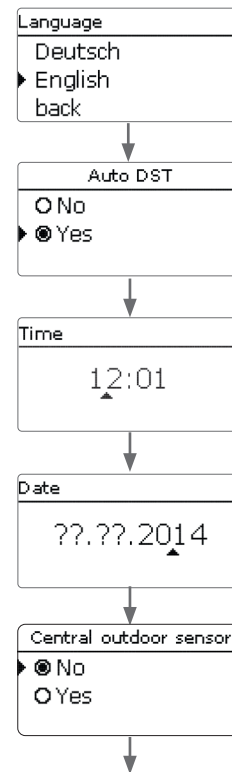

6. Completing the commissioning menu:

After the selection, a security enquiry appears. If the safety enquiry is confirmed, the adjustments are saved.

- ➔ In order to confirm the security enquiry, press the right button (✓).
- ➔ In order to reenter the commissioning menu channels, press the left button (↶).

If the security enquiry has been confirmed, the controller is ready for operation and should enable an optimum system operation.

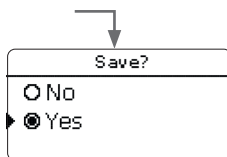

Adjusting the operating mode:

After commissioning the heating circuit will be in automatic mode. The operating mode can be changed in the status menu:

- Automatic
- Day
- Night
- Holiday
- Off



Note:

The adjustments carried out during commissioning can be changed anytime in the corresponding adjustment channel. Additional functions and options can also be activated or deactivated (see page 16).

Set the code to the customer code before handing over the controller to the customer (see page 26).

4.1 Basic settings

The controller is preprogrammed for 1 basic system. The basic pre-adjustments have already been made.

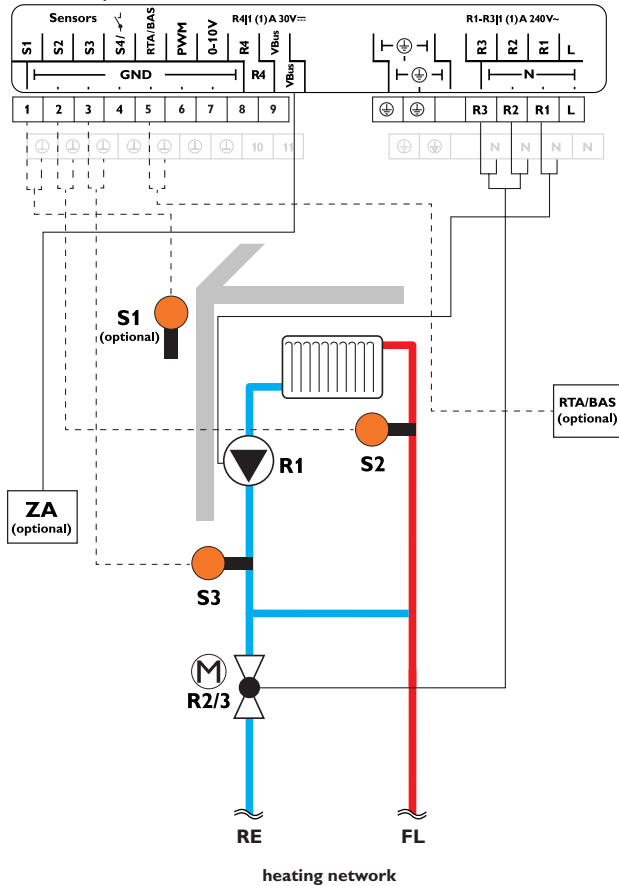

Sensors

S1	Outdoor	1 / GND
S2	Flow HC	2 / GND
S3	Return	3 / GND
S4	Room thermostat	4 / GND
S5	Remote control / operating mode switch	5 / GND

Relay

R1	HC pump	R1 / N / PE
R2	Valve open	R2 / N / PE
R3	Valve closed	R3 / N / PE
R4	Free	8 / 10

By means of the flow sensor S2 and the outdoor temperature sensor S1, a mixed weather-compensated heating circuit can be controlled.

5 Functions and options

5.1 Menu structure

Main menu

- Status
- Heating
- Basic settings
- SD card
- Manual mode
- User code

Heating

- Heating circuit
- Screed drying

Basic settings

- Language
- Auto DST
- Time
- ...
- Factory setting

Heating circuit

- Interval
- Heat. sys.
- Heating curve
- Centr. outd. sen.
- ...
- TFrost
- Chimney sweeper



The menu items and adjustment values selectable are variable depending on adjustments already made. The figure only shows an exemplary excerpt of the complete menu in order to visualise the menu structure.

5.2 Status menu

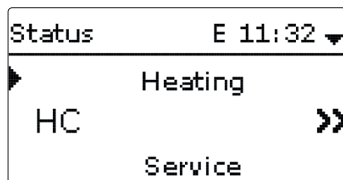

The status menu contains information about the current state of the heating circuits. Furthermore, measured and balance values as well as messages are indicated.

5.3 Heating

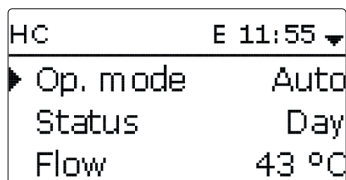

In the **Status/HC** menu, the status of the heating circuit is indicated. The status of the heating circuit is also the home screen of the controller. In this menu, the operating mode of the heating circuit can be changed:

Automatic: Automatic heating mode.

Day: Constant heating mode with the adjusted day correction.

Night: Constant heating mode with the adjusted night correction and the selected correction mode.

Holiday: Constant heating mode within an adjustable time frame with the adjusted night correction and the selected correction mode.

Off: The heating circuit is switched off. The antifreeze function of the heating circuit remains active.

5.4 Meas./Balance values

In the **Status/Meas./Balance** menu, all current measurement values as well as a range of balance values are displayed. Some of the menu items can be selected in order to enter a submenu.

Each sensor and relay is indicated with the component or function it has been allocated to. The symbol ▶ at the edge of the display next to a sensor allocated to a function, means that this sensor has several functions. Use the Lightwheel® to scroll to these functions. The sensors and relays of the controller are listed in numerical order.

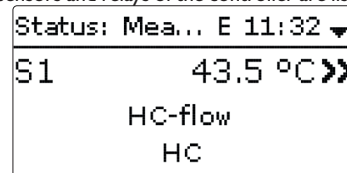

When a line with a measurement value is selected, another submenu will open.

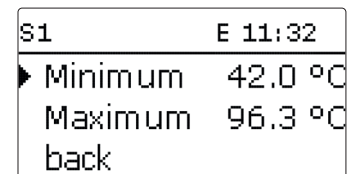

If, for example, S1 is selected, a submenu indicating the minimum and maximum values will open.

5.5 Messages

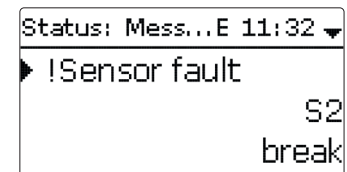

In the **Status/ Messages** menu, error and warning messages which have not been acknowledged are indicated.

During normal operation, the message **Everything OK** is indicated.

A short circuit (**short-circuit**) or line break (**break**) in a sensor line is indicated as **!Sensor fault**.

6 Heating

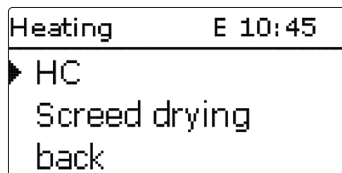

In this menu, all adjustments for the heating circuit can be made. Additionally, the screed drying function can be activated and adjusted.

Heating circuit

The controller has one heating circuit. The following heating circuit variants are possible:

- 1 mixed weather-compensated heating circuit
- 1 mixed constant heating circuit

If the measured flow temperature deviates from the set flow temperature, the valve will be controlled in order to adjust the flow temperature correspondingly.

The control runtime can be adjusted with the parameter **Interval**.

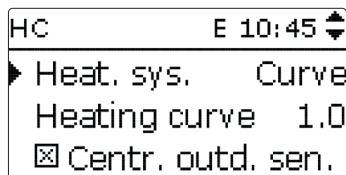
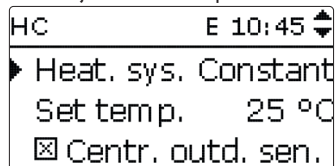

The heating system **Constant** aims to keep the set flow temperature to a constant value which can be adjusted by means of the parameter **Set temperature**.

If the heating system **Curve** is selected, the controller calculates a set flow temper-

ature by means of the outdoor temperature and the selected **Heating curve**. In both cases, the dial setting of the remote control and the controller day correction or night correction are added.

Heating system Constant:

Set flow temperature = set temperature + remote control + day correction or night correction

Heating system Curve:

Set flow temperature = heating curve temperature + remote control + day correction or night correction

The calculated set flow temperature is limited by the adjusted values of the parameters **Maximum flow temperature** and **Minimum flow temperature**.

Flow maximum temperature ≥ set flow temperature ≥ flow minimum temperature

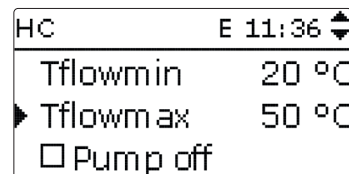

The parameter **Pump off** is used for switching off the heating circuit pump, if the adjusted value of the maximum flow temperature is exceeded by 5 K.

If the outdoor temperature sensor is defective, an error message will be indicated. For the duration of this condition, 0 °C is assumed as the outdoor temperature.

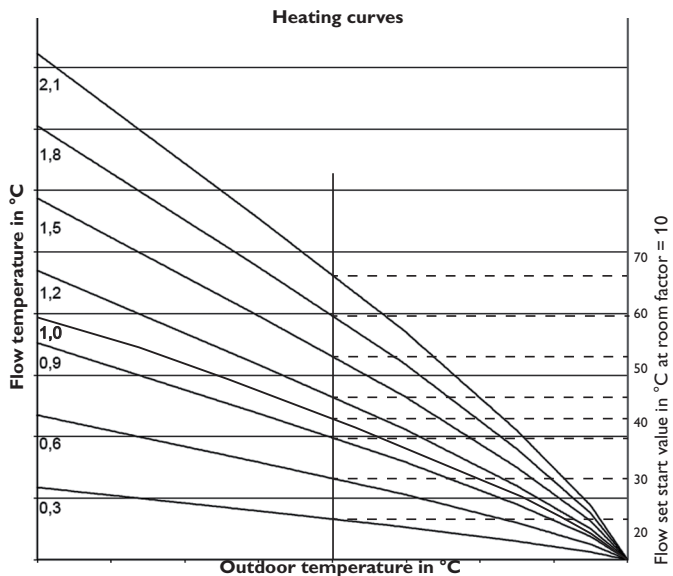

Room influence

If the heating system **Constant** is selected, the **Room influence** option will be available. The weather-compensated set flow temperature will thus be expanded by a demand-based room control.

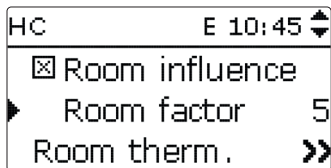

The parameter **Room factor** can be used for determining the intensity of the room influence.

Room factor < 10

If the room factor is < 10, the controller will calculate the set flow temperature using the heating system Curve plus the room influence:

Set flow temperature = set temperature + remote control + day correction or night correction + room influence.

Room factor = 10

If the room factor is equal to 10, the controller will calculate the set flow temperature by means of the room influence, the outdoor temperature will not be taken into account.

An outdoor temperature sensor cannot be allocated. The parameters **Day/Night correction**, **Timer** and **TSummer** will not be indicated.

The start value of the set flow temperature can be influenced by the parameter **Heating curve**. The start value corresponds to the set flow value of the selected curve at an outdoor temperature of 0 °C.

Set flow temperature = set flow start value + room influence

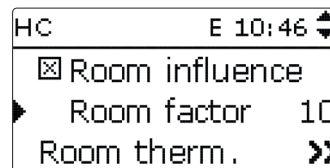

In order to calculate the deviation of the room temperature from the adjusted set value, a room thermostat is required. The adjustments can be made using the parameter **RTH**. RTH is always pre-adjusted for the room influence.

Room thermostat option

In order to integrate a room thermostat into the control logic without activating the room influence option, proceed as follows:

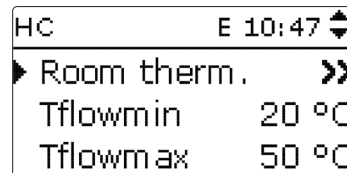

With the **Room thermostat** option, 1 room thermostat can be integrated into the control logic.

A sensor input can be allocated to the room thermostat. The temperature at the allocated sensor is monitored. If the measured temperature exceeds the adjusted value **TambSet** at all activated room thermostats and if the parameter **HC off** is activated, the heating circuit will switch off.

A common room thermostat with a potential-free output can be used alternatively.

In this case, **Switch** must be selected in the **Type** channel.

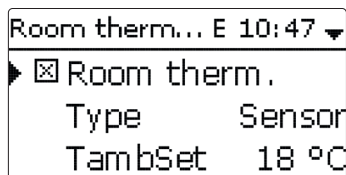

When the **Timer** option is activated, a timer is indicated in which time frames for the function can be adjusted. During these time frames, the adjusted room temperature decreases by the **Correction** value.



Note:

For information on timer adjustment see 10.

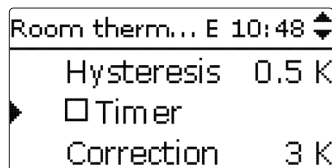

Relay 4 is allocated to the room thermostat. The relay will switch on when the temperature falls below the adjusted room temperature. This way, the room in question can be excluded from the heating circuit via a valve as long as the desired room temperature is reached.

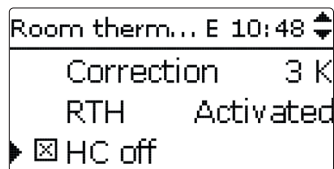

With the parameter **RTH**, the room thermostat can be temporarily deactivated or re-activated respectively. All adjustments remain stored.

The **Return limit value** option monitors the return temperature. If it exceeds the value **T-ret.**, the flow temperature will be decreased in order to avoid a too high return temperature. The parameter **Factor** can be used for defining to which extend the deviation may influence the correction of the flow temperature. The higher the factor, the higher the flow correction.

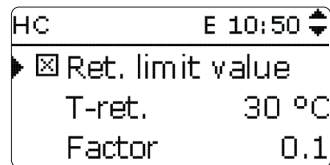

Correction timer

With the **Timer**, the day/night operation can be adjusted. During day phases, the set flow temperature is increased by the adjusted **Day correction** value, during night phases it is decreased by the **Night correction** value (night setback).

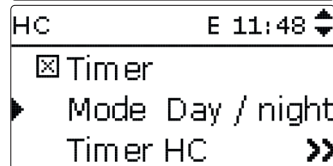
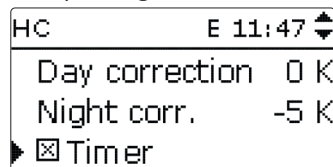

The parameter **Mode** is used for selecting between the following correction modes:
Day/night: A reduced set flow temperature (night correction) is used during night operation.

Day/off: The heating circuit switches off during night operation.

Outdoor/off: The heating circuit switches off during night operation. If the temperature falls below the adjusted limit temperature at the allocated outdoor temperature sensor, the controller changes to the reduced heating mode.

The **Timer HC** parameter can be used for adjusting the time frames for day operation.

Summer mode

HC	E 11:48
▶ TSummer	20 °C
Daytime on	00:00
Daytime off	00:00

The automatic summer mode becomes active when the outdoor temperature exceeds the adjusted summer temperature **TSummer**. This can be limited to a daytime frame with the parameters **Daytime on** and **Daytime off**. Outside the adjusted time frame, the lower temperature **TNight** is used in summer mode. In summer mode, the heating circuit is switched off.

HC	E 11:48
Daytime on	09:00
Daytime off	19:00
▶ TNight	14 °C

Remote access

The following types of remote access are possible:

Remote control: A device which allows manual adjustment of the heating curve, thus influencing the set flow temperature.

➔ In order to use a remote control, set the **Type** to **RTA**

Room control unit: A device incorporating a remote control as well as an additional operating mode switch.

➔ In order to use a room control unit, set the **Type** to **BAS**.

The operating mode switch of the room control unit is used for adjusting the operating mode of the controller. If a room control unit is used, the operating mode can be adjusted by means of the room control unit only. The controller menu only allows the activation of the operating mode **Holiday**.

HC	E 11:54
▶ <input type="checkbox"/> Remote access	
Sen. Frost	Flow
TFrost	5 °C

Antifreeze function

The antifreeze function of the heating circuit can be used to temporarily activate an inactive heating circuit during sudden temperature drop in order to protect it against frost damage.

The temperature at the allocated antifreeze sensor **Sen. Frost** is monitored. If the temperature falls below the adjusted antifreeze temperature **TFrost**, the heating circuit will be activated until the antifreeze temperature is exceeded by 2K, but at least for 30 min.

Chimney sweeper function

The chimney sweeper function can be used for enabling quick access to measurement conditions without having to navigate through the menu.

HC	E 11:55
TFrost	5 °C
▶ <input checked="" type="checkbox"/> Chimney sweeper	
back	

The chimney sweeper function is activated by default. The chimney sweeper mode can be activated by pressing microbutton  for 3 s.

In the chimney sweeper mode, the valve opens, the heating circuit pump is activated. If the chimney sweeper function is active, the Lightwheel® flashes yellow. Additionally, **Chimney sweeper** and a countdown of 30 min are indicated on the display.

When the countdown has elapsed, the chimney sweeper mode is automatically deactivated. If, during the countdown, microbutton  is again pressed for more than 3 s, the chimney sweeper mode will end.

Heating/Heating circuit

Adjustment channel	Description	Adjustment range/selection	Factory setting
Interval	Valve control runtime	1...20s	4 s
Heat. sys.	Heating system selection	Curve, Constant	PWM characteristic curve
Heating curve	Heating curve	0.3...3.0	1.0
Set temp.	Set temperature	10...100°C	25°C
Centr. outd. sen.	Central outdoor sensor unit option	Yes, No	No
Room influence	Room influence option	Yes, No	No
Room factor	Room influence factor	1...10	5
Room therm.	Room thermostats sub-menu	-	-
Room therm.	Room thermostat option	Yes, No	No
Type	Room thermostat type selection	Sensor, Switch	Sensor
TambSet	Room temperature	10...30°C	18°C
Hysteresis	RTH hysteresis	0.5...20.0 K	0.5 K
Timer	RTH timer	Yes, No	No
Correction	Correction	1...20K	3K
RTH	Room thermostat	Activated, Deactivated	Activated
HC off	Heating circuit off option	Yes, No	No
Tflowmin	Minimum flow temperature	20...89°C	20°C
Tflowmax	Maximum flow temperature	21...90°C	50°C
Pump off	Deactivation of the heating circuit pump when Tflowmax is exceeded	Yes, No	No
Ret. limit value	Return limit value option	Yes, No	No
T-ret.	Return limit value	20...60°C	30°C
Factor	Flow correction factor	0.1...1.0	0.1
Day correction	Day correction	-5...+45 K	0 K
Night corr.	Night correction	-20...+30K	-5K
Timer	Timer option	Yes, No	No
Mode	Correction mode selection	Day/night, Day/Off, Outdoor/Off	Day/night
TLimit	Limit temperature	-20...+30°C	16°C/0°C
Timer HC	Heating circuit timer	Yes, No	No
TSummer	Summer temperature day	0...40°C	20°C
Daytime on	Daytime on	00:00...23:45	00:00
Daytime off	Daytime off	00:00...23:45	00:00
TNight	Summer temperature night	0...40°C	14°C

Adjustment channel	Description	Adjustment range/selection	Factory setting
Remote access	Remote access option	Yes, No	No
Type	Remote access type selection	RTA, BAS	RTA
Sen. Frost	Antifreeze sensor	Flow, Outdoor	Flow
TFrost	Antifreeze temperature	+4...+10°C/ -20...+10°C	+5°C/0°C
Chimney sweeper	Chimney sweeper option	Yes, No	Yes

6.1 Screed drying

This function is used for time- and temperature-controlled screed drying for the heating circuit.

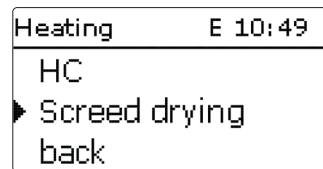

Note:

The screed drying function is blocked against the chimney sweeper function. In order to activate the screed drying function, the chimney sweeper function must be deactivated.

In the **Heating/Screed drying** menu the function can be set to standby by using the **Activated** item.

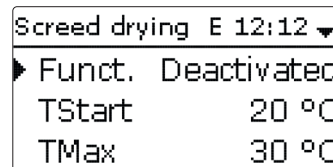

If the microbutton  is pressed and held down for at least 3 s, the screed drying programme will start.

The message **Screed drying** will be indicated on the display and the remaining time will be indicated as a countdown (dd:hh). During this process, the Lightwheel® will be flashing red.

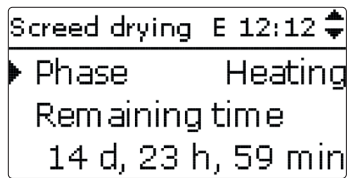

If the microbutton  is pressed again and held down for at least 3 s, the screed drying function will be cancelled. For this reason, a security enquiry appears. If you wish to interrupt the screed drying function, confirm the safety enquiry.

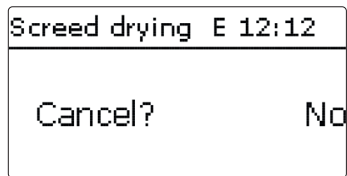

At the beginning of the screed drying function, the heating circuit is put into operation for the adjusted **Rise time** with the start temperature as the set flow temperature. Afterwards, the set flow temperature increases in steps by the adjustable rise value for the duration of the adjustable rise time until the holding temperature is reached. After the holding time has elapsed, the set flow temperature is reduced in steps until the start temperature is reached again.

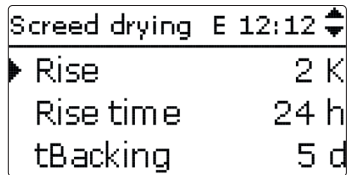

If the set flow temperature is not reached within 24 hours or after the rise time respectively, or if it is constantly exceeded, the screed drying function will be cancelled.

The heating circuit switches off and an error message is displayed. The Light-wheel® flashes red.

- Error 1: flow sensor defective

- Error 2: the flow temperature is higher than the maximum flow temperature + 5 K for over 5 min

- Error 3: the flow temperature is higher than the holding temperature + rise value for over 30 min

- Error 4: the flow temperature is higher than the set flow temperature + rise value for over 2 h

- Error 5: the flow temperature is lower than the set flow temperature - rise value for over a rise time period

The left button () can be used any time for changing to the status or main menu of the controller in order to carry out adjustments.

When the screed drying function has been successfully completed, the heating circuit changes to its previously selected operating mode.

Screed drying is automatically deactivated. The chimney sweeper function is automatically activated.



Note:

Make sure the heating circuit is supplied with heat from a heat source.



Note:

If a Micro SD card has been inserted into the slot, a screed protocol will be generated.

Heating/Screed drying

Adjustment channel	Description	Adjustment range/ selection	Factory setting
Funct.	Activation / Deactivation	Activated, Deactivated	Deactivated
TStart	Start temperature	10 ... 30 °C	20 °C
TMax	Holding temperature	20 ... 60 °C	30 °C
Rise	Temperature increase per rise time	1 ... 10 K	2 K
Rise time	Duration for emperature increase	1 ... 24 h	24 h
tBacking	TMax holding time	1 ... 20 d	5 d

7 Basic settings

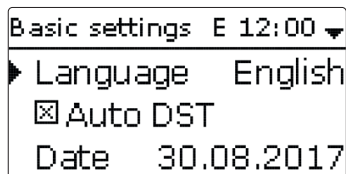

In the **Basic settings** menu, all basic parameters for the controller can be adjusted. Normally, these settings have been made during commissioning. They can be subsequently changed in this menu.

Basic settings

Adjustment channel	Description	Adjustment range/ selection	Factory setting
Language	Selection of the menu language	Deutsch, English, Français, Español, Italiano	Deutsch
Auto DST	Daylight savings time selection	Yes, No	Yes
Date	Adjustment of the current date	01.01.2001 ... 31.12.2099	01.01.2014
Time	Adjustment of the current time	00:00 ... 23:59	-
Reset	back to factory setting	Yes, No	No

8 SD card

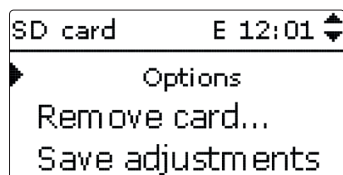

The controller is equipped with a MicroSD card slot for MicroSD memory cards. With a MicroSD card, the following functions can be carried out:

- Logging measurement and balance values. After the transfer to a computer, the values can be opened and visualised, e. g. in a spreadsheet.
- Store adjustments and parameterisations on the MicroSD card and, if necessary, retrieve them from there.
- Running firmware updates on the controller.

Running firmware updates

When a MicroSD card with a firmware update is inserted, the enquiry **Update?** is indicated on the display.

→ In order to run an update, select **Yes** and confirm with the right button (✓).

The update is run automatically. The indication **Please wait** and a progress bar appear on the display. When the update has been completed, the controller will automatically reboot and run a short initialisation phase.



Note:

Only remove the card when the initialisation phase has been completed and the status menu is indicated on the controller display!

→ To skip the update, select **No**.

The controller starts normal operation.



Note:

The controller will only recognise a firmware update file if it is stored in a folder named **WUES** on the first level of the MicroSD card.

→ Create a folder named **WUES** on the MicroSD card and extract the downloaded ZIP file into this folder.

Starting the logging

1. Insert the MicroSD card into the slot.
2. Adjust the desired logging type and interval.

Logging will start immediately.

Completing the logging process

1. Select the menu item **Remove card...**
2. After **Remove card** is displayed, remove the card from the slot.

When **Linear** is adjusted in the **Logging type** adjustment channel, data logging will stop if the capacity limit is reached. The message **Card full** will be displayed.

If **Cyclic** is adjusted, the oldest data logged onto the SD card will be overwritten as soon as the capacity limit is reached.



Note:

Because of the increasing size of the data packets, the remaining logging time does not decrease linearly. The data packet size can increase, e. g. with the increasing operating hours value.

Storing controller adjustments

→ To store the controller adjustments on the MicroSD card, select the menu item **Save adjustments**.

While the adjustments are being stored, first **Please wait**, then **Done!** will be indicated on the display. The controller adjustments are stored as a .SET file on the MicroSD card.

Loading controller adjustments

- To load controller adjustments from a MicroSD card, select the menu item **Load adjustments**.

The **File selection** window is indicated.

- Select the desired .SET file.

While the adjustments are being loaded, first **Please wait**, then **Done!** will be indicated on the display.



Note:

To safely remove the MicroSD card, always select the menu item **Remove card ...** before removing the card.

SD card

Adjustment channel	Description	Adjustment range/ selection	Factory setting
Remove card...	Safely remove card	-	-
Save adjustments	Save adjustments	-	-
Load adjustments	Load adjustments	-	-
Logging interval	Interval for Data logging	00:01 ... 20:00 (mm:ss)	01:00
Logging type	Logging type	Cyclic, Linear	Linear

9 Manual mode

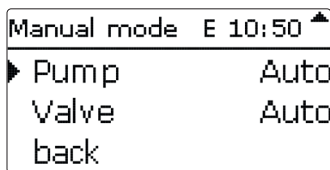

In the **Manual mode** menu, the operating mode of all relays of the controller can be adjusted.

All relays are listed in numerical order.

In the menu item **All relays...**, all relays can be switched off (Off) or set to automatic mode (Auto) at once:

Off = Relay is switched off (manual mode)

Auto = Relay is in automatic mode

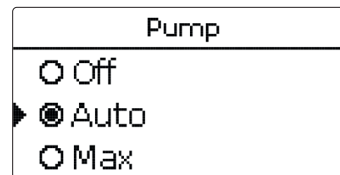

The operating mode can be selected for each individual relay, too. The following options are available:

Off = Relay is switched off (manual mode)

Min. = Relay active with minimum speed (manual mode)

Max. = Relay active at 100% speed (manual mode)

Auto = Relay is in automatic mode



Note:

After service and maintenance work, the relay mode must be set back to **Auto**. Normal operation is not possible in manual mode.

Manual mode

Adjustment channel	Description	Adjustment range/ selection	Factory setting
Pump	Operating mode selection	Max, Auto, Min, Off	Auto
Valve	Operating mode selection	Max, Auto, Min, Off	Auto
All relays...	Operating mode of all relays	Auto, Off	Off

10 User code

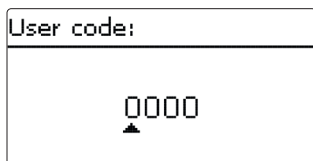

The access to some adjustment values can be restricted via a user code (customer).

1. Installer **0262** (Factory setting)

All menus and adjustment values are shown and all values can be altered.

2. Customer **0000**

The installer level is not shown, adjustment values can be changed partly.

For safety reasons, the user code should generally be set to the customer code before the controller is handed to the customer!

➔ In order to restrict the access, enter 0000 in the menu item **User code**.

11 Troubleshooting

WARNING! Electric shock!



Upon opening the housing, live parts are exposed!

➔ **Always disconnect the device from power supply before opening the housing!**

The controller is protected by a fuse. The fuse holder (which also holds the spare fuse) becomes accessible when the cover is removed. To replace the fuse, pull the fuse holder from the base.

If a malfunction occurs, a message will appear on the display of the controller.

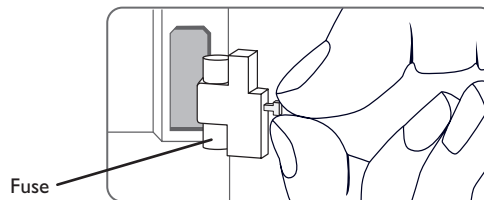

The Lightwheel® flashes red.

Sensor fault. An error code instead of a temperature is shown on the sensor display channel.

Short circuit or line break
Disconnected temperature sensors can be checked with an ohmmeter. Please check if the resistance values correspond with the table.

°C	°F	Ω Pt1000	°C	°F	Ω Pt1000
-10	14	961	55	131	1213
-5	23	980	60	140	1232
0	32	1000	65	149	1252
5	41	1019	70	158	1271
10	50	1039	75	167	1290
15	59	1058	80	176	1309
20	68	1078	85	185	1328
25	77	1097	90	194	1347
30	86	1117	95	203	1366
35	95	1136	100	212	1385
40	104	1155	105	221	1404
45	113	1175	110	230	1423
50	122	1194	115	239	1442

The display is permanently off.

Press the right button (✓). Display illuminated?

no

yes

Controller has been in standby, everything o.k.

Check the power supply of the controller. Is it disconnected?

no

yes

The fuse of the controller could be blown. The fuse holder (which holds the spare fuse) becomes accessible when the cover is removed. The fuse can then be replaced.

Check the supply line and reconnect it.

The heating circuit pump does not work, although this is indicated on the display.

Display illuminated?

If not, press the right button (✓).

Display illuminated again?

yes

no

There is no current; check fuses / replace them and check power supply.

Does the pump start up in manual operation?

no

yes

The adjusted temperature difference for starting the pump is too high; choose a value which makes more sense.

Is the pump current enabled by the controller?

no

yes

Controller might be defective - replace it.

Is the pump stuck?

yes

Turn the pump shaft using a screwdriver; now passable?

no

Pump is defective - replace it.



Sensors



Outdoor temperature sensors



Central outdoor sensor unit



Remote control



Room control unit

12.1 Sensors and measuring instruments

Sensors

The product range includes high-precision platinum temperature sensors, flatscrew sensors, outdoor temperature sensors, indoor temperature sensors, cylindrical clip-on sensors, also as complete sensors with immersion sleeve.

Remote control

With the remote control, the heating curve can be comfortably adjusted from the living area.

Room control unit

With the room control unit, the heating curve can be comfortably adjusted from the living area. The integrated sensor measures the ambient temperature.

Outdoor temperature sensor

The outdoor temperature sensor is used for measuring the outdoor temperature with a Pt1000 measuring element. The outdoor temperature sensor is placed in a weather-resistant housing and is designed for mounting outdoors. Cable glands for the sensor cables at the bottom of the housing allow easy installation.

Central outdoor sensor unit

The central outdoor sensor unit detects the outdoor temperature and transmits this value via the VBus® to the controllers connected.

A	
Accessories.....	29
Antifreeze function.....	21
Automatic mode.....	14
B	
Balance values.....	17
Basic settings.....	24
C	
Chimney sweeper function.....	8, 21
Commissioning menu.....	13
Control lamp.....	8
Controller adjustments, loading of.....	25
Controller adjustments, storing of.....	24
Countdown.....	21
D	
Day correction.....	20
Day/Night operation.....	20
F	
Fuse, replacing of.....	26
H	
Heating curve.....	18
I	
Interval.....	18
L	
Lightwheel®.....	8
M	
Mains supply.....	7
Maximum flow temperature.....	18
Meas. values.....	17
Messages.....	17
Microbuttons.....	8
MicroSD.....	7, 24
Minimum flow temperature.....	18
Mixer runtime.....	18
Modulating heating control.....	18
N	
Night correction.....	18
Night operation.....	20
O	
Operating mode, relays.....	25
Operating mode switch.....	21
R	
Remote access.....	21
Remote control.....	18
Room control.....	19
Room control unit.....	21
Room influence.....	19
Room thermostat.....	19
Running firmware updates.....	24
S	
Screed drying.....	22
Sensor fault, error message.....	17
Set flow temperature.....	18
Set temperature.....	18
Start temperature.....	23
Summer mode.....	21
U	
User code.....	26

Distributed by:

RESOL – Elektronische Regelungen GmbH

Heiskampstraße 10
45527 Hattingen / Germany

Tel.: +49 (0) 23 24 / 96 48 - 0

Fax: +49 (0) 23 24 / 96 48 - 755

www.resol.com

info@resol.com

Important note

The texts and drawings in this manual are correct to the best of our knowledge. As faults can never be excluded, please note:

Your own calculations and plans, under consideration of the current standards and directions should only be basis for your projects. We do not offer a guarantee for the completeness of the drawings and texts of this manual - they only represent some examples. They can only be used at your own risk. No liability is assumed for incorrect, incomplete or false information and / or the resulting damages.

Note

The design and the specifications can be changed without notice.

The illustrations may differ from the original product.

Imprint

This mounting- and operation manual including all parts is copyrighted. Another use outside the copyright requires the approval of RESOL – Elektronische Regelungen GmbH. This especially applies for copies, translations, micro films and the storage into electronic systems.

© **RESOL – Elektronische Regelungen GmbH**