

DeltaTherm® HC MAX

RESOL®

Beginning with firmware version 2.04

Heating controller

Manual for the
specialised craftsman

Installation

Operation

Functions and options

Troubleshooting



11213305



The Internet portal for easy and secure access to
your system data – www.vbus.net

Thank you for buying this RESOL product.

Please read this manual carefully to get the best performance from this unit. Please keep this manual safe.

en

Manual

www.resol.com

Safety advice

Please pay attention to the following safety advice in order to avoid danger and damage to people and property.

Instructions

Attention must be paid to the valid local standards, regulations and directives!

Information about the product

Proper usage

The controller is designed for use in heating systems in compliance with the technical data specified in this manual.

Improper use excludes all liability claims.

EU declaration of conformity

The product complies with the relevant directives and is therefore labelled with the CE mark. The Declaration of Conformity is available upon request, please contact the manufacturer.



Note

Strong electromagnetic fields can impair the function of the controller.

- Make sure the controller as well as the system are not exposed to strong electromagnetic fields.

Target group

These instructions are exclusively addressed to authorised skilled personnel.

Only qualified electricians are allowed carry out electrical works.

Initial commissioning must be effected by the system installer or qualified personnel named by the system installer.

Subject to technical change. Errors excepted.

Description of symbols

WARNING!

Warnings are indicated with a warning triangle!



- They contain information on how to avoid the danger described.

Signal words describe the danger that may occur, when it is not avoided.

- **WARNING** means that injury, possibly life-threatening injury, can occur.
- **ATTENTION** means that damage to the appliance can occur.



Note

Notes are indicated with an information symbol.

- Arrows indicate instruction steps that should be carried out.

Disposal

- Dispose of the packaging in an environmentally sound manner.
- At the end of its working life, the product must not be disposed of as urban waste. Old appliances must be disposed of by an authorised body in an environmentally sound manner. Upon request we will take back your old appliances bought from us and guarantee an environmentally sound disposal of the devices.



The DeltaTherm® HC MAX can control up to 4 weather-compensated heating circuits, the DHW loading and the backup heating demand for both. Additional DHW functions such as circulation or thermal disinfection, and the efficient implementation of further heat sources are possible.

With extension modules, further heating circuits can be controlled. Due to the flexible application and extension possibilities, the heating controller is also ideal for larger objects such as apartment houses, residential homes and industrial buildings.

Contents

1 Overview	4	8 Heating	34
1.1 Optional functions	5	8.1 Shared relays.....	34
2 Installation	5	8.2 Heating circuits	36
2.1 Mounting	5	8.3 Optional functions	44
2.2 Electrical connection	7	8.4 Screed drying.....	47
2.3 Data communication / Bus	8	9 Arrangement	49
2.4 SD card slot.....	8	9.1 Optional functions	49
3 Step-by-step parameterisation	9	10 HQM	58
4 Operation and function	10	11 Basic settings	59
4.1 Buttons	10	12 SD card	60
4.2 Selecting menu points and adjusting values	10	13 Manual mode	61
4.3 Adjusting the timer	12	14 User code	61
4.4 Adjusting optional functions	14	15 Inputs / Modules	62
4.5 Output selection submenu	16	15.1 Modules	62
5 Commissioning	19	15.2 Inputs.....	62
5.1 Schemes with basic settings.....	21	16 Troubleshooting	64
6 Main menu	31	17 Accessories	66
6.1 Menu structure	32	18 Index	68
7 Status	33		
7.1 Measured / Balance values.....	33		
7.2 Heating.....	33		
7.3 Arrangement.....	33		
7.4 HQM.....	33		
7.5 Messages.....	34		
7.6 Home screen.....	34		

1 Overview

- Up to 5 extension modules via **RESOL VBus®** connectable (45 sensors and 39 relays in total), up to 7 weather-compensated heating circuits
- 2 inputs for digital Grundfos Direct Sensors™
- 2 inputs for analogue Grundfos Direct Sensors™
- Screenshotting function
- Data logging, storing, easy transfer of controller adjustments prepared and firmware updates via SD card
- Cooling over the heating circuit with condensation detection by means of a dew point switch
- Modulating heating control with 0-10 V boiler control
- Weather-compensated control with room influence or demand-based room control with up to 5 room temperature sensors HC per heating circuit
- Remote access with a room control unit or the **VBus®Touch HC App**

Technical data

Inputs: 12 Pt1000, Pt500 or KTY temperature sensor inputs (can optionally be used for remote controls, operating mode switches or potential-free switches), 3 impulse inputs for V40 flowmeters (can optionally be used for Pt1000, Pt500 or KTY temperature sensors, remote controls, operating mode switches or potential-free switches), 1 input for a FlowRotor, 1 CS10 solar cell, 4 Grundfos Direct Sensors™ (2 x analogue, 2 x digital)

Outputs: 14 relays, 13 of them semiconductor relays for speed control, 1 potential-free relay, 4 PWM outputs (switchable to 0-10 V)

PWM frequency: 512 Hz

PWM voltage: 10.5 V

Switching capacity:

1 (1) A 240 V~ (semiconductor relay)

4 (2) A 24 V= / 240 V~ (potential-free relay)

Total switching capacity: 6.3 A 240 V~

Power supply: 100 ... 240 V~ (50 ... 60 Hz)

Supply connection: type Y attachment

Standby: 0.83 W

Temperature controls class: VIII

Energy efficiency contribution: 5%

Mode of operation: type 1.B.C.Y action

Rated impulse voltage: 2.5 kV

Data interface: RESOL VBus®, SD card slot

VBus® current supply: 35 mA

Functions: screenshotting, weather-compensated heating circuit control, backup heating, DHW heating with priority logic, circulation, thermal disinfection, heat quantity measurement, optional functions such as solid fuel boiler, return preheating, etc.

Housing: plastic, PC-ABS and PMMA

Mounting: wall mounting, also suitable for mounting into patch panels

Indication / Display: full graphic display

Operation: 7 buttons

Protection type: IP 20 / EN 60529

Protection class: I

Ambient temperature: 0 ... 40 °C

Degree of pollution: 2

Dimensions: 253 × 200 × 47 mm

1.1 Optional functions

Heating	Arrangement
Thermal disinfection	Parallel relay
DHW heating	Mixer
DHW preheating	Zone loading
	Error relay
	Heat exchange
	Solid fuel boiler
	Circulation
	Return preheating
	Function block
	Irradiation switch
	Return mixing function

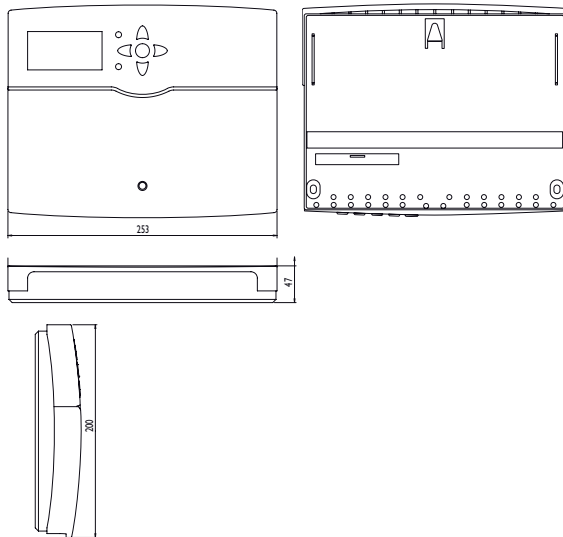

2 Installation

2.1 Mounting

WARNING! Electric shock!



Upon opening the housing, live parts are exposed!

→ **Always disconnect the device from power supply before opening the housing!**



Note

Strong electromagnetic fields can impair the function of the device.

→ Make sure the device as well as the system are not exposed to strong electromagnetic fields.

The unit must only be located in dry interior rooms.

The controller must additionally be supplied from a double pole switch with contact gap of at least 3 mm.

Please pay attention to separate routing of sensor cables and mains cables.

In order to mount the device to the wall, carry out the following steps:

- Unscrew the crosshead screw from the cover and remove it along with the cover from the housing.
- Mark the upper fastening point on the wall. Drill and fasten the enclosed wall plug and screw leaving the head protruding.
- Hang the housing from the upper fastening point and mark the lower fastening points (centres 233 mm).
- Insert lower wall plugs.
- Fasten the housing to the wall with the lower fastening screws and tighten.
- Carry out the electrical wiring in accordance with the terminal allocation (see page 7).
- Put the cover on the housing.
- Attach with the crosshead screw.

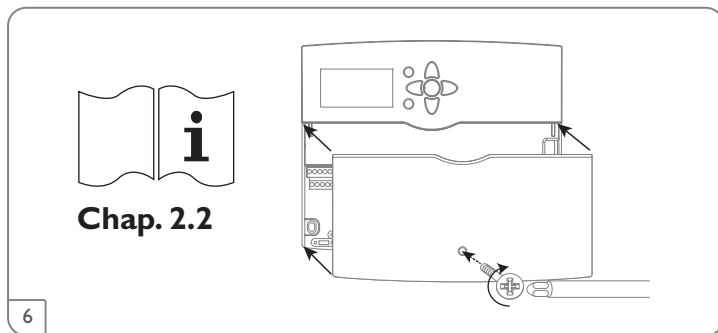
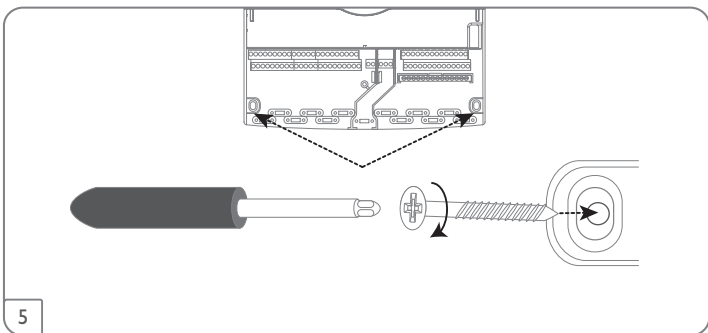
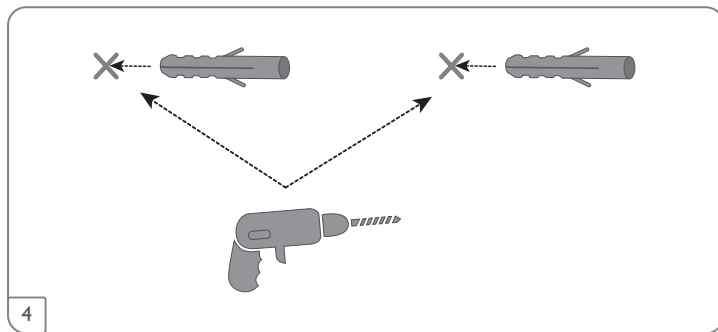
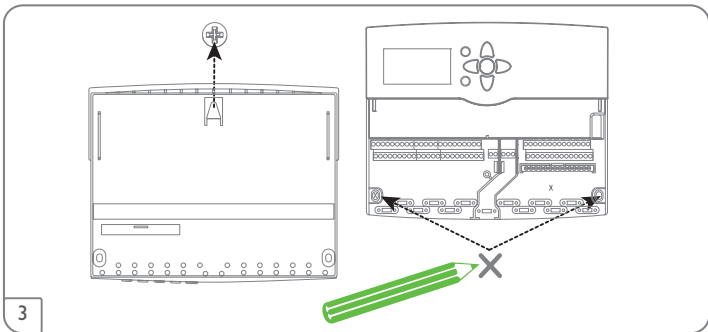
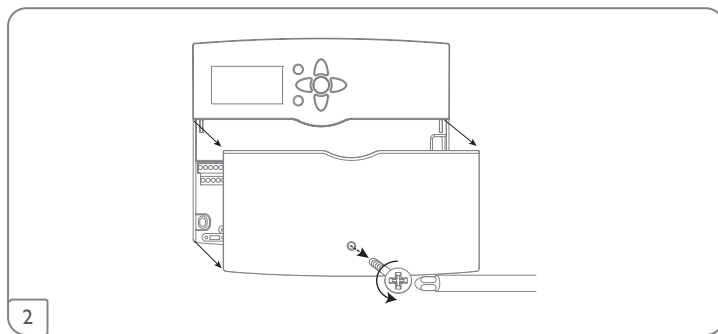
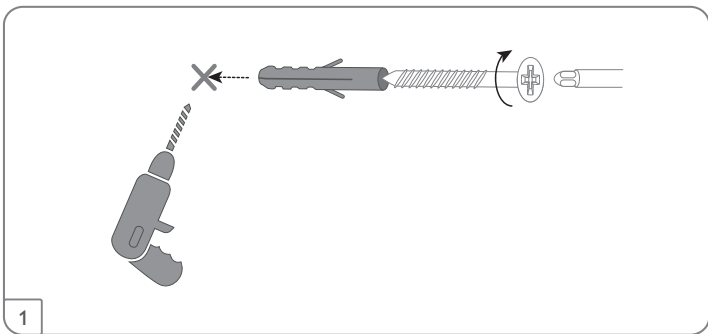

2.2 Electrical connection

WARNING! Electric shock!



Upon opening the housing, live parts are exposed!
 → **Always disconnect the device from power supply before opening the housing!**

ATTENTION! ESD damage!



Electrostatic discharge can lead to damage to electronic components!
 → **Take care to discharge properly before touching the inside of the device! To do so, touch a grounded surface such as a radiator or tap!**



Note
 Connecting the device to the power supply must always be the last step of the installation!



Note
 The pump speed must be set to 100% when auxiliary relays or valves are connected.



Note
 It must be possible to disconnect the device from the mains at any time.
 → Install the mains plug so that it is accessible at any time.
 → If this is not possible, install a switch that can be accessed.

Do not use the device if it is visibly damaged!

The controller is equipped with 14 relays in total to which loads such as pumps, valves, etc. can be connected:

Relays 1 ... 13 are semiconductor relays, designed for pump speed control:
 Conductor R1 ... R13

Neutral conductor N (common terminal block)

Protective earth conductor ⊕ (common terminal block)

Relay 14 is a potential-free relay:

R14-A = normally open contact

R14-M = centre contact

R14-R = normally closed contact

Depending on the product version, mains cables and sensor cables are already connected to the device. If that is not the case, please proceed as follows:

The **temperature sensors** (S1 to S12) have to be connected to the terminals S1 to S12 and GND (either polarity).

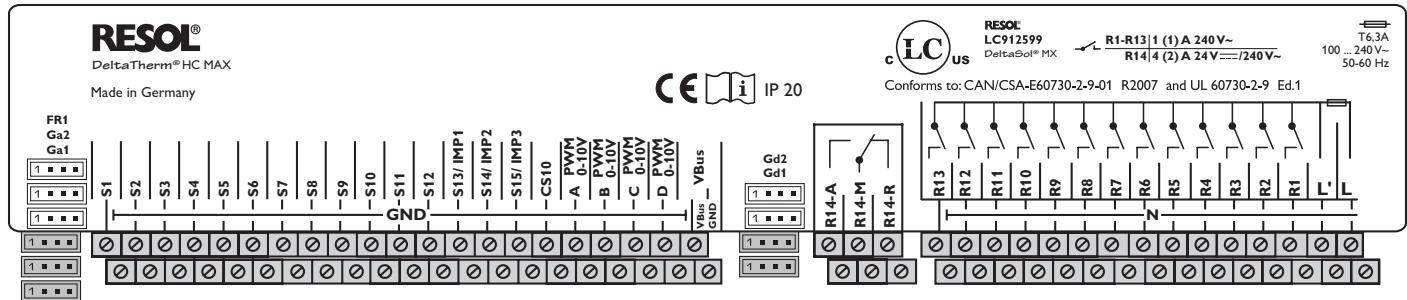

The **V40** flowmeters can be connected to the terminals S13/IMP1 to S15/IMP3 and GND (either polarity).

Connect the irradiation sensor **CS10** to the terminals CS10 and GND with correct polarity. To do so, connect the cable marked GND to the GND common terminal block, the cable marked CS to the terminal marked CS10.

The terminals marked **PWM/0-10V** are control outputs for high-efficiency pumps.



Note

When Grundfos Direct Sensors™ are used, connect the sensor ground common terminal block to PE.

Connect the **analogue Grundfos Direct Sensors™** to the Ga1 and Ga2 inputs.

Connect the **digital Grundfos Direct Sensors™** to the Gd1 and Gd2 inputs.

Connect the **FlowRotor** to the FR1 input. (The FlowRotor is not available in the RESOL portfolio)

The controller is supplied with power via a mains cable. The power supply of the device must be 100... 240V~ (50... 60 Hz).

Connect the **mains cable** to the following terminals:

Neutral conductor N

Conductor L

WARNING! Electric shock!



L' is a fused contact permanently carrying voltage.

→ **Always disconnect the device from power supply before opening the housing!**

Conductor L' (L' is not connected with the mains cable. L' is a fused contact permanently carrying voltage)

Protective earth conductor ⊕ (common terminal block)



Note

For more details about the commissioning procedure see page 9.

2.3 Data communication / Bus

The controller is equipped with the RESOL VBus® for data transfer and energy supply to external modules. The connection is to be carried out at the terminals marked **VBus** (any polarity).

One or more RESOL VBus® modules can be connected via this data bus, such as:

- RESOL DL2/DL3 Datalogger
- RESOL KM2 Communication module

Furthermore, the controller can be connected to a PC or integrated into a network via the RESOL VBus®/USB or VBus® /LAN interface adapter (not included). Different solutions for visualisation and remote parameterisation are available on the website www.resol.com. On the website, firmware updates are also available.



Note

During remote parameterisation, the  symbol will be displayed, the controller will not carry out any control function.



Note

For more information about accessories, see page 66.

2.4 SD card slot

The controller is equipped with an SD card slot.

With an SD card, the following functions can be carried out:

- Store measurement and balance values onto the SD card. After the transfer to a computer, the values can be opened and visualised, e.g. in a spreadsheet.
- Prepare adjustments and parameterisations on a computer and transfer them via the SD card.
- Store adjustments and parameterisations on the SD card and, if necessary, retrieve them from there.
- Download firmware updates from the Internet and install them on the controller.

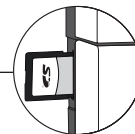

Note

For more information about using an SD card, see page 60.

3 Step-by-step parameterisation

The *DeltaTherm*[®] HC MAX is a controller that offers a broad variety of functions to the user. At the same time, the user has a lot of freedom in configuring them. Therefore, to set up a complex system, careful planning is required. We recommend drawing a sketch of the system first.

If planning, hydraulic construction and electrical connection have all been carried out successfully, proceed as follows:

1. Running the commissioning menu

After the commissioning menu has been finished (see page 19), further adjustments can be made. The commissioning menu can be repeated any time by means of a reset (see page 59). Additional adjustments will be deleted.

For further information about the commissioning menu see page 19.

2. Registering sensors

If flowmeters, flow switches, Grundfos Direct Sensors[™], a FlowRotor, room control units, remote controls, switches and/or external extension modules are connected, these have to be registered in the **Inputs / Modules** menu.

For further information about the registration of modules and sensors see page 62.

3. Adjusting heating circuits and activating optional heating functions

If one or more heating circuits are to be controlled, heating circuits can be activated and adjusted.

For the heating part of the arrangement, up to 16 optional functions can be selected, activated and adjusted.

To heating circuits and optional functions which require one or more relays, the corresponding number of free relays can be allocated. The controller always suggests the numerically smallest relay available.

Sensors can be allocated to more than one function.

For further information about heating circuits and optional heating functions see page 36.

4. Activating optional arrangement functions

Up to 16 optional functions can be selected, activated and adjusted in the arrangement part.

Relays available can be allocated to optional functions which require a relay. The controller always suggests the numerically smallest relay available.

Sensors can be allocated to more than one function.

For further information about the optional arrangement functions see page 49.

4 Operation and function

4.1 Buttons

The controller is operated via the 7 buttons next to the display. They have the following functions:

- Button ① - scrolling upwards
- Button ③ - scrolling downwards
- Button ② - increasing adjustment values
- Button ④ - reducing adjustment values
- Button ⑤ - confirming
- Button ⑥ - entering the status menu / chimney sweeper mode (system-dependent)
- Button ⑦ - escape button for changing into the previous menu / to the holidays menu

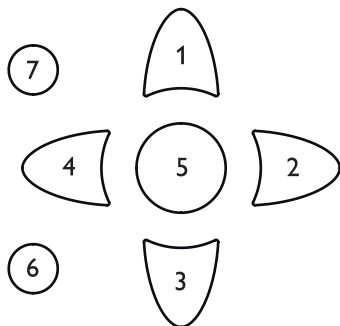

Operating control LED (in the directional pad)

- Green: Everything OK
- Red: Cancellation screed drying
- Red flashing: Sensor fault / initialisation / chimney sweeper function active
- Green flashing: Manual mode / screed drying active

4.2 Selecting menu points and adjusting values

During normal operation of the controller, the display is in the main menu. If no button is pressed for 1 min, the display illumination goes out. After 4 further minutes, the controller will display the home screen (see page 34).

Press any key to reactivate the display illumination.

- ➔ In order to scroll through a menu or to adjust a value, press either buttons ① and ③ or buttons ② and ④.
- ➔ To open a submenu or to confirm a value, press button ⑤.
- ➔ To enter the status menu, press button ⑥ – unconfirmed adjustments will not be saved.
- ➔ To enter the previous menu, press button ⑦ – unconfirmed adjustments will not be saved.

If no button has been pressed within a couple of minutes, the adjustment is cancelled and the previous value is retained.

HC 1	
▶ Op. mode	Auto
Status	Day
Flow	40 °C

If the symbol ▶▶ is shown behind a menu item, pressing button ⑤ will open a new submenu.

Relay selec.	
▶▶ Controller	⬆
R1	
R2	

If the symbol ⊕ is shown in front of a menu item, pressing button ⑤ will open a new submenu. If it is already opened, a ⊖ is shown instead of the ⊕.

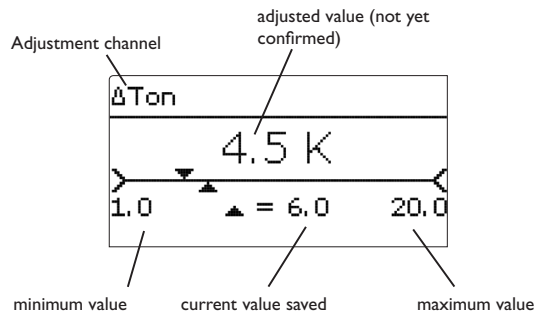

Values and options can be changed in different ways:

Numeric values can be adjusted by means of a slide bar. The minimum value is indicated to the left, the maximum value to the right. The large number above the slide bar indicates the current adjustment. By pressing buttons **2** or **4** the upper slide bar can be moved to the left or to the right.

Only after the adjustment has been confirmed by pressing button **5** will the number below the slide bar indicate the new value. The new value will be saved if it is confirmed by pressing button **5** again.

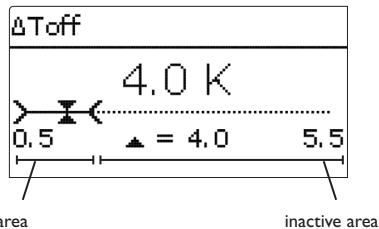

When 2 values are locked against each other, they will display a reduced adjustment range depending on the adjustment of the respective other value.

In this case, the active area of the slide bar is shortened, the inactive area is indicated as a dotted line. The indication of the minimum and maximum values will adapt to the reduction.

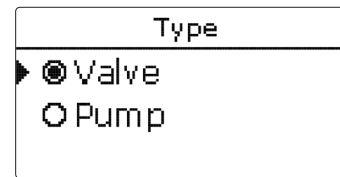

If only one item of several can be selected, they will be indicated with radio buttons. When one item has been selected, the radio button in front of it is filled.

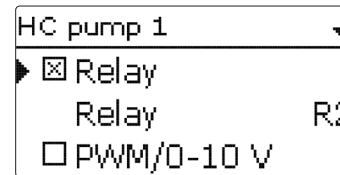

If more than one item of several can be selected, they will be indicated with checkboxes. When an item has been selected, an x appears inside the checkbox.

4.3 Adjusting the timer

When the **Timer** option is activated, a timer is indicated in which time frames for the function can be adjusted.

In the **Day selection** channel, the days of the week are available individually and as frequently selected combinations.

If more than one day or combination is selected, they will be merged into one combination for the following steps.

The last menu item after the list of days is **Continue**. If **Continue** is selected, the timer menu opens, in which the time frames can be adjusted.

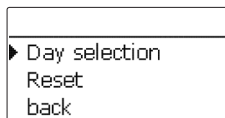

Day selection
Reset
back

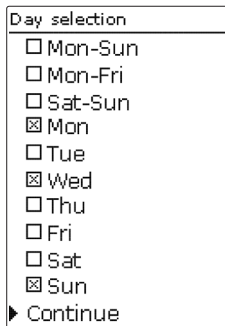

Day selection
 Mon-Sun
 Mon-Fri
 Sat-Sun
 Mon
 Tue
 Wed
 Thu
 Fri
 Sat
 Sun
▶ Continue

→ In order to save the time frame, select **Save** and confirm the security enquiry with **Yes**.

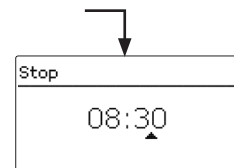

Stop
08:30

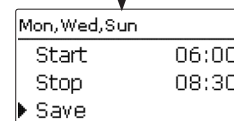

Mon, Wed, Sun
Start 06:00
Stop 08:30
▶ Save

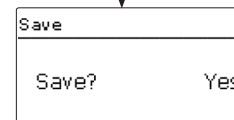

Save
Save? Yes

→ In order to add another time frame, repeat the previous steps.

6 time frames can be adjusted per day or combination.

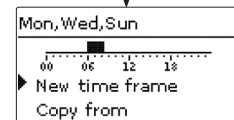

Mon, Wed, Sun
00 06 12 18
▶ New time frame
Copy from

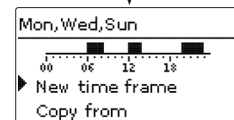

Mon, Wed, Sun
00 06 12 18
▶ New time frame
Copy from

Adding a time frame:

In order to add a time frame, proceed as follows:

→ Select **New time frame**.

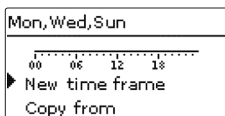

Mon, Wed, Sun
00 06 12 18
▶ New time frame
Copy from

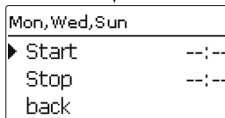

Mon, Wed, Sun
▶ Start --:--
Stop --:--
back

→ Adjust **Start** and **Stop** for the desired time frame. The time frames can be adjusted in steps of 5 min.



Start
06:00

→ Press the left button (←) in order to get back to the day selection.

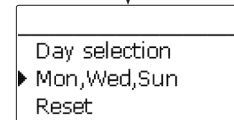

Day selection
▶ Mon, Wed, Sun
Reset

Copying a time frame:

In order to copy time frames already adjusted into another day / another combination, proceed as follows:

- ➔ Choose the day / the combination into which the time frames are to be copied and select **Copy from**.

A selection of days and / or combinations with time frames will appear:

- ➔ Select the day or combination from which the time frames are to be copied.

All time frames adjusted for the selected day or combination will be copied. If the time frames copied are not

changed, the day or combination will be added to the combination from which the time frames have been copied.

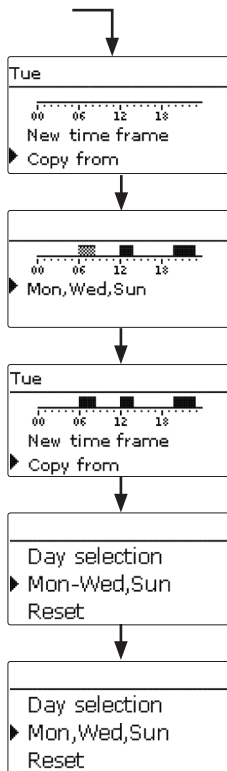

Changing a time frame:

In order to change a time frame, proceed as follows:

- ➔ Select the time frame to be changed.
- ➔ Make the desired change.

- ➔ In order to save the time frame, select **Save** and confirm the security enquiry with **Yes**.

Removing a time frame:

In order to delete a time frame, proceed as follows:

- ➔ Select the time frame that is to be deleted.
- ➔ Select **Delete** and confirm the security enquiry with **Yes**.

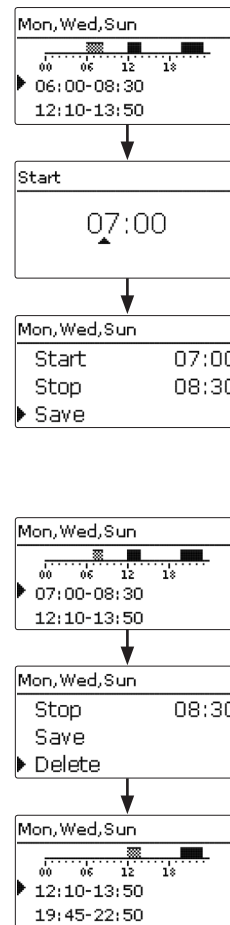

Resetting the timer:

In order to reset time frames adjusted for a certain day or combination, proceed as follows

→ Select the desired day or combination.

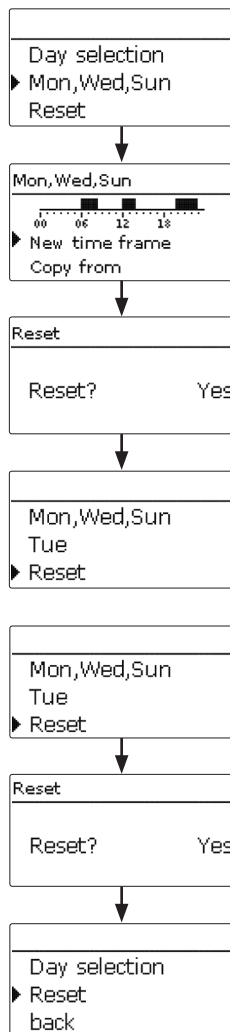

→ Select **Reset** and confirm the security enquiry with **Yes**.

The selected day or combination will disappear from the list, all its time frames will be deleted.

In order to reset the whole timer, proceed as follows:

→ Select **Reset** and confirm the security enquiry with **Yes**.

All adjustments made for the timer are deleted.

4.4 Adjusting optional functions

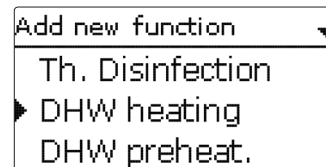

In the **Optional functions** menus, optional functions can be selected and adjusted. By selecting **Add new function**, different pre-programmed functions can be selected.

The kind and number of optional functions offered depends on the previous adjustments.

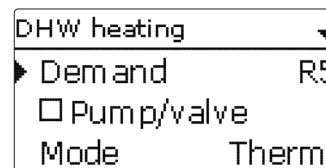

When a function is selected, a submenu will open in which all adjustments required can be made.

In this submenu, an output and, if necessary, certain system components can be allocated to the function.

If an output can be allocated to the function, the output selection menu **Output** will open (see page 16).

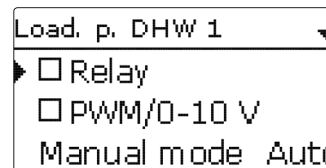

When a function has been adjusted and saved, it will appear in the **Opt. functions** menu above the menu item **Add new function**.

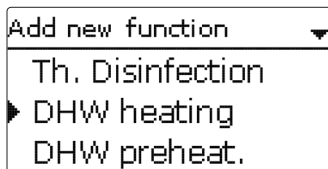

This allows an easy overview of functions already saved.

An overview about which sensor has been allocated to which component and which relay has been allocated to which function is given in the **Status** menu.

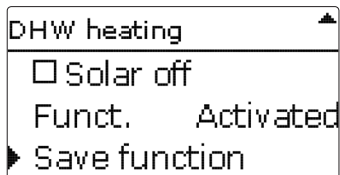

At the end of each optional function submenu, the menu items **Function** and **Save function** are available. In order to save a function, select **Save function** and confirm the security enquiry by selecting **Yes**.

In functions already saved, the menu item **Delete function** will appear instead.

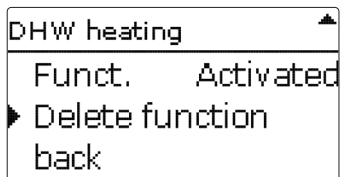

In order to delete a function already saved, select **Delete function** and confirm the security enquiry by selecting **Yes**. The function will become available under **Add new function** again. The corresponding outputs will be available again.

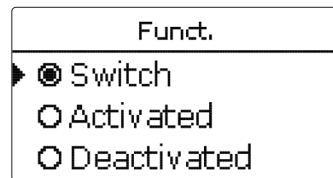

With the menu item **Function**, an optional function already saved can be temporarily deactivated or re-activated respectively. In this case, all adjustments will remain stored, the allocated outputs will remain occupied and cannot be allocated to another function. The allocated sensor will be monitored for faults.

By selecting **Switch**, the function can be activated or deactivated respectively by means of an external potential-free switch.

The selection is only available if a sensor input has previously been set to Switch in the **Inputs/Modules** menu.

If **Switch** is selected, the channel **Sensor** will appear. In this channel, the sensor input to which the switch is to be connected can be allocated to the function.

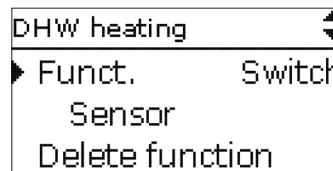

4.5 Output selection submenu

The **Output selection** submenu is available in almost all optional functions. Therefore, it will not be explained in the individual function descriptions.

In this submenu, relays and/or signal outputs can be allocated to the function selected. All adjustments required for the outputs can be made in this menu.

All controller and module (if connected) outputs available will be displayed. If - is selected, the function will run normally in the software but will not operate an output. Relay and signal outputs can be activated separately. Depending on the adjustments made, the following results are possible:

Adjustment channel	Description	Adjustment range / selection	Factory setting
Relay	Relay option	Yes, No	No
Relay	Relay selection	system dependent	system dependent
PWM/0-10V	PWM/0-10V option	Yes, No	No
Output	Signal output selection	system dependent	system dependent
Signal	Signal type	PWM, 0-10V	PWM
Profile	Curve	Solar, Heating	Solar
Speed	Speed control	Yes, No	system dependent
Min.	Minimum speed	20 ... 100%	20%
Max.	Maximum speed	20 ... 100%	100%
Adapter	Adapter option	Yes, No	No
Inverted	Inverted switching option	Yes, No	No
Blocking protection	Blocking protection option	Yes, No	No
Manual mode	Operating mode	Max, Auto, Min, Off	Auto

1 relay and/or 1 0-10V output can be allocated to each output selection.

Settings

Relay option	PWM/0-10V option	Speed control	Adapter option
Yes	Yes	Yes	Yes
Yes	No	Yes	No
Yes	No	Yes	Yes
Yes	No	No	irrelevant*
Yes	Yes	Yes	No
Yes	Yes	Yes	Yes
Yes	Yes	No	irrelevant*
No	Yes	Yes	irrelevant*
No	Yes	No	irrelevant*

Result

Behaviour of the relay output	Behaviour of the signal output	Behaviour of the adapter
→ On/Off	Modulating	Modulating
→ Burst control	-	Modulating
→ On/Off	-	Modulating
→ On/Off	-	0% / 100%
→ On/Off	Modulating	0% / 100%
→ On/Off	Modulating	Modulating
→ On/Off	0% / 100%	0% / 100%
→ -	Modulating	-
→ -	0% / 100%	-

* If the Relay option and/or speed control is deactivated, the adjustment in the adapter option will have no effect.

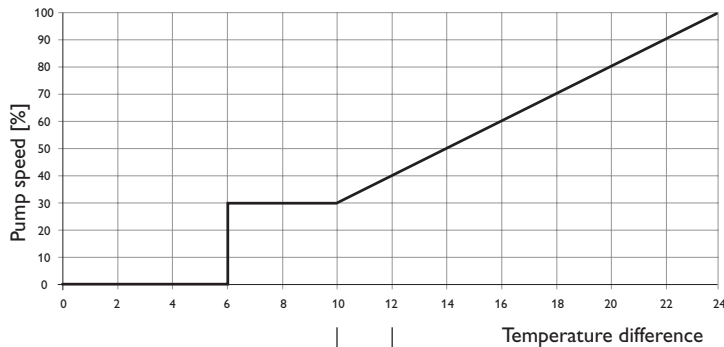

Detail

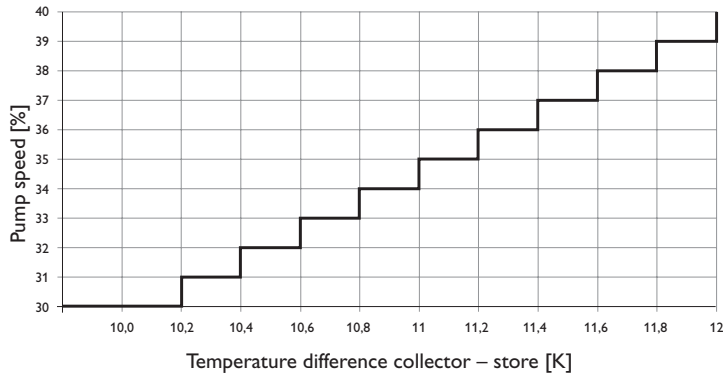

Speed control

In the **Speed** adjustment channel, the speed control for the output can be activated or deactivated respectively. If **Yes** is selected, the channels **Min.**, **Max** and **Adapter** will appear.

In the **Min.** adjustment channel, a relative minimum speed for a pump connected can be allocated to the output.

In the **Max.** adjustment channel, a relative maximum speed for a pump connected can be allocated to the output.

If the speed control signal is generated via a VBus® / PWM interface adapter, the **Adapter** option has to be activated. If **Yes** is selected, the relay will switch on or off (no burst control). Speed information will be transmitted via the VBus®.

For functions controlling loads which are not speed controlled, the speed control will not be shown on the display (e. g. the bypass type, mixer).

If the temperature difference reaches or exceeds the Switch-on temperature difference, the pump switches on at 100% speed for 10 s. Then, the speed is reduced to the Minimum pump speed value. If the temperature difference exceeds the adjusted Set value by 1/10 of the rise value, the pump speed increases by one step (1%). The response of the controller can be adapted via the parameter Rise. Each time the difference increases by 1/10 of the adjustable Rise value, the pump speed increases by one step until the Maximum pump speed of 100% is reached. If the temperature difference decreases by 1/10 of the adjustable Rise value, pump speed will be decreased by one step.

Relay option

If the **Relay** option is activated, a relay can be allocated to the output selection.

0-10 V option

If the 0-10 V option is activated, a **0-10 V** output can be allocated to the output selection.

In the **Signal** channel, a selection between a PWM or a 0-10 V signal can be made. In the **Profile** channel, characteristic curves for solar and heating pumps can be selected.

Signal characteristic: PWM; Profile: Solar

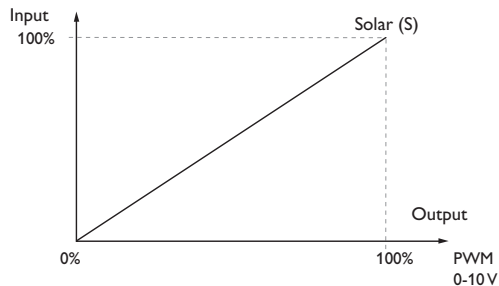

Signal characteristic: PWM; Profile: Heating

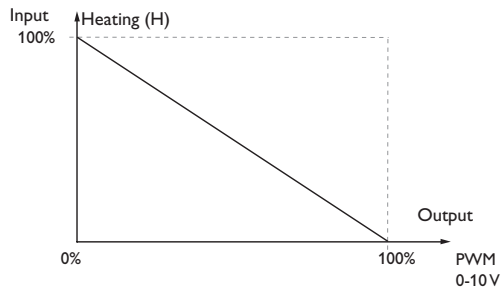

Blocking protection

In order to protect the pumps against blocking after standstill, the controller is equipped with a blocking protection option. This option can be activated in the output selection submenu. The **Blocking protection** option can be adjusted in the **Basic setting/Blocking protection** menu (see page 59).

Manual mode

In the **Manual mode** adjustment channel, the operating mode of the output can be selected. The following options are available:

Off = Output is switched off (manual mode)

Min = Output active at minimum speed (manual mode)

Max = Output active at 100% speed (manual mode)

Auto = Output is in automatic mode



Note

After service and maintenance work, the operating mode must be set back to Auto. Normal operation is not possible in manual mode.

5 Commissioning

When the hydraulic system is filled and ready for operation, connect the controller to the mains.

The controller runs an initialisation phase in which the directional pad glows red. When the controller is commissioned or when it is reset, it will run a commissioning menu after the initialisation phase. The commissioning menu leads the user through the most important adjustment channels needed for operating the system.

Commissioning menu

The commissioning menu consists of the channels described in the following. In order to make an adjustment, press button **5**. Adjust the value by pressing buttons **4** and **2**, then push button **5** to confirm. The next channel will appear in the display.

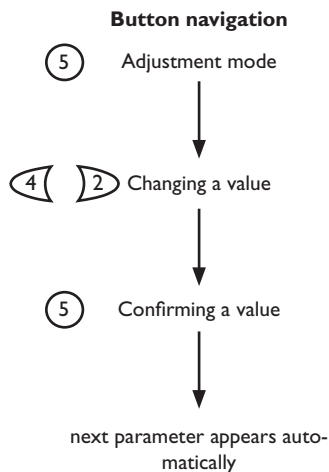

1. Language:

→ Adjust the desired menu language.

Language
Deutsch
▶ English
Francais

2. Units:

→ Adjust the desired unit system.

Units
<input type="radio"/> °F / gal / MBTU
▶ <input checked="" type="radio"/> °C / Liter / kWh

3. Daylight savings time adjustment:

→ Activate or deactivate the automatic daylight savings time adjustment.

Auto DST
▶ <input checked="" type="radio"/> Yes
<input type="radio"/> No

4. Time:

→ Adjust the clock time. First of all adjust the hours, then the minutes.

Time
12:26

5. Date:

→ Adjust the date. First of all adjust the year, then the month and then the day.

Date
?? ?? 2018

6. Selection: Scheme

→ Choose if the controller is to be configured with a scheme.

Scheme
▶ <input checked="" type="radio"/> Yes
<input type="radio"/> No

7. Scheme (if 6. =Yes):

- ➔ Enter the scheme number of the desired system.

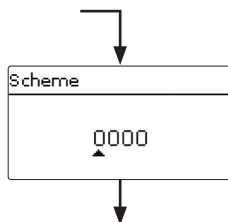

8. Completing the commissioning menu:

After the system has been selected or the scheme number has been entered, a security enquiry appears. If the security enquiry is confirmed, the adjustments will be saved.

- ➔ In order to confirm the security enquiry, press button **5**.
- ➔ In order to reenter the commissioning menu channels, press button **7**. If the security enquiry has been confirmed, the controller will be ready for operation and should enable an optimum system operation.

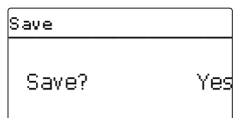

Note

The adjustments carried out during commissioning can be changed anytime in the corresponding adjustment channel. Additional functions and options can also be activated or deactivated (see page 31).

Set the code to the customer code before handing over the controller to the customer (see page 61).

5.1 Schemes with basic settings

The controller is pre-programmed for 36 schemes. The basic pre-adjustments have already been made. For backup heating it is necessary to allocate the demand and the boiler loading pump by means of shared relays. Afterwards the system can easily be extended.

Relay and sensor allocation correspond to the figures. Scheme 0 has no pre-adjustments.

Overview: 9 basic systems with one heating circuit

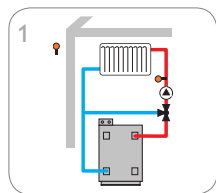

1 mixed heating circuit

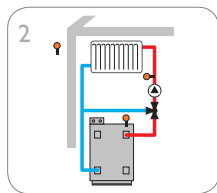

1 mixed heating circuit with backup heating

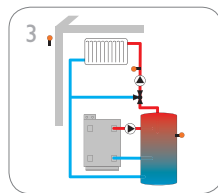

1 mixed heating circuit with backup heating and loading pump

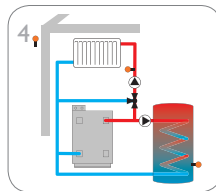

1 mixed heating circuit with DHW heating

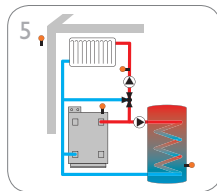

1 mixed heating circuit with DHW heating and backup heating

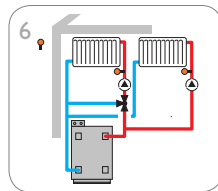

1 mixed and 1 unmixed heating circuit

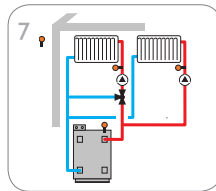

1 mixed and 1 unmixed heating circuit with backup heating

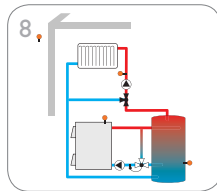

1 mixed heating circuit with solid fuel boiler

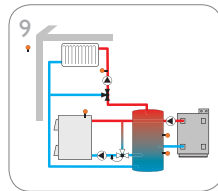

1 mixed heating circuit with solid fuel boiler and backup heating

Each basic system has 4 schemes which result from the number of heating circuits. The scheme number consists of 4 digits. The first digit indicates the temperature controls class. The second digit indicates the number of heating circuits, the third and the fourth the desired basic system.

Example:

In order to select system 3 with the settings for 2 heating circuits, enter the scheme number 0203.

0	2	0	3
Temperature controls class	Number of heating circuits	Number of the desired scheme; with a 0 in front of it for numbers with 1 digit	

Scheme 1: 1 mixed heating circuit

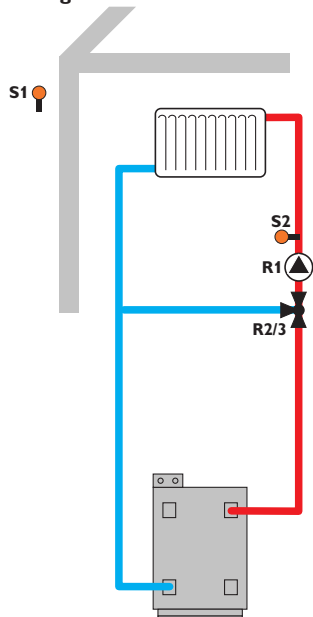

By means of the flow sensor S2 and the outdoor temperature sensor S1, a mixed weather-compensated heating circuit can be controlled.

Scheme no.	0101	0201	0301	0401
Sensors				
S1	Outdoor	Outdoor	Outdoor	Outdoor
S2	Flow HC1	Flow HC1	Flow HC1	Flow HC1
S3		Flow HC2	Flow HC2	Flow HC2
S4			Flow HC3	Flow HC3
S5				Flow HC4
S6				
S7				
S8				
S9				
S10				
S11				
S12				
Relay				
R1	Pump HC1	Pump HC1	Pump HC1	Pump HC1
R2	Mixer open HC1	Mixer open HC1	Mixer open HC1	Mixer open HC1
R3	Mixer closed HC1	Mixer closed HC1	Mixer closed HC1	Mixer closed HC1
R4		Pump HC2	Pump HC2	Pump HC2
R5		Mixer open HC2	Mixer open HC2	Mixer open HC2
R6		Mixer closed HC2	Mixer closed HC2	Mixer closed HC2
R7			Pump HC3	Pump HC3
R8			Mixer open HC3	Mixer open HC3
R9			Mixer closed HC3	Mixer closed HC3
R10				Pump HC4
R11				Mixer open HC4
R12				Mixer closed HC4
R13				
R14				

Scheme 2: 1 mixed heating circuit with backup heating (demand)

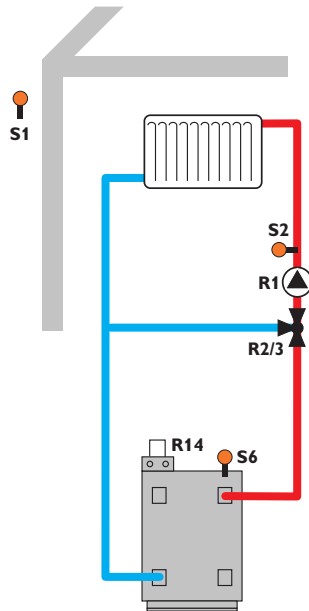

By means of the flow sensor S2 and the outdoor temperature sensor S1, a mixed weather-compensated heating circuit can be controlled. Boiler demand via the potential-free relay is triggered depending on the temperature difference between the set flow temperature and the value measured at the backup heating sensor S6.

Scheme no.	0102	0202	0302	0402
Sensors				
S1	Outdoor	Outdoor	Outdoor	Outdoor
S2	Flow HC1	Flow HC1	Flow HC1	Flow HC1
S3		Flow HC2	Flow HC2	Flow HC2
S4			Flow HC3	Flow HC3
S5				Flow HC4
S6	BH HC1	BH HC1,2	BH HC1,2,3	BH HC1,2,3,4
S7				
S8				
S9				
S10				
S11				
S12				
Relay				
R1	Pump HC1	Pump HC1	Pump HC1	Pump HC1
R2	Mixer open HC1	Mixer open HC1	Mixer open HC1	Mixer open HC1
R3	Mixer closed HC1	Mixer closed HC1	Mixer closed HC1	Mixer closed HC1
R4		Pump HC2	Pump HC2	Pump HC2
R5		Mixer open HC2	Mixer open HC2	Mixer open HC2
R6		Mixer closed HC2	Mixer closed HC2	Mixer closed HC2
R7			Pump HC3	Pump HC3
R8			Mixer open HC3	Mixer open HC3
R9			Mixer closed HC3	Mixer closed HC3
R10				Pump HC4
R11				Mixer open HC4
R12				Mixer closed HC4
R13				
R14	BH HC1	BH HC1,2	BH HC1,2,3	BH HC1,2,3,4

Scheme 3: 1 mixed heating circuit with backup heating (demand and boiler loading pump)

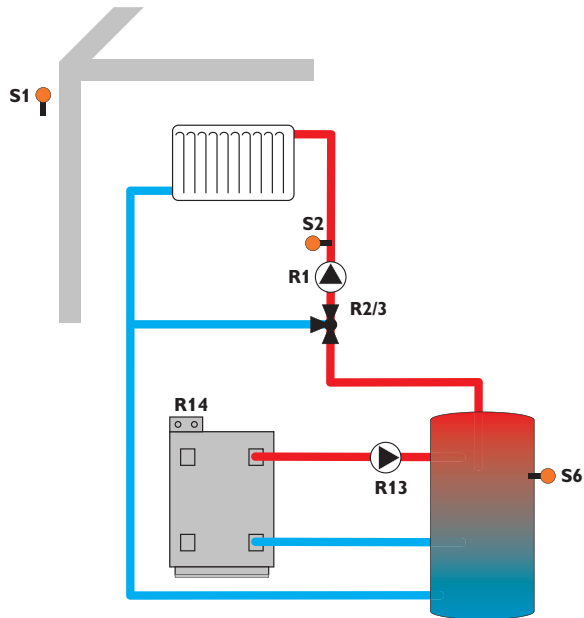

By means of the flow sensor S2 and the outdoor temperature sensor S1, a mixed weather-compensated heating circuit can be controlled.

Boiler demand via the potential-free relay and boiler loading pump control are triggered depending on the temperature difference between the set flow temperature and the value measured at the backup heating sensor S6.

Scheme no.	0103	0203	0303	0403
Sensors				
S1	Outdoor	Outdoor	Outdoor	Outdoor
S2	Flow HC1	Flow HC1	Flow HC1	Flow HC1
S3		Flow HC2	Flow HC2	Flow HC2
S4			Flow HC3	Flow HC3
S5				Flow HC4
S6	BH HC1	BH HC1,2	BH HC1,2,3	BH HC1,2,3,4
S7				
S8				
S9				
S10				
S11				
S12				
Relay				
R1	Pump HC1	Pump HC1	Pump HC1	Pump HC1
R2	Mixer open HC1	Mixer open HC1	Mixer open HC1	Mixer open HC1
R3	Mixer closed HC1	Mixer closed HC1	Mixer closed HC1	Mixer closed HC1
R4		Pump HC2	Pump HC2	Pump HC2
R5		Mixer open HC2	Mixer open HC2	Mixer open HC2
R6		Mixer closed HC2	Mixer closed HC2	Mixer closed HC2
R7			Pump HC3	Pump HC3
R8			Mixer open HC3	Mixer open HC3
R9			Mixer closed HC3	Mixer closed HC3
R10				Pump HC4
R11				Mixer open HC4
R12				Mixer closed HC4
R13	Loading pump BH	Loading pump BH	Loading pump BH	Loading pump BH
R14	BH HC1	BH HC1,2	BH HC1,2,3	BH HC1,2,3,4

Scheme 4: 1 mixed heating circuit with DHW heating

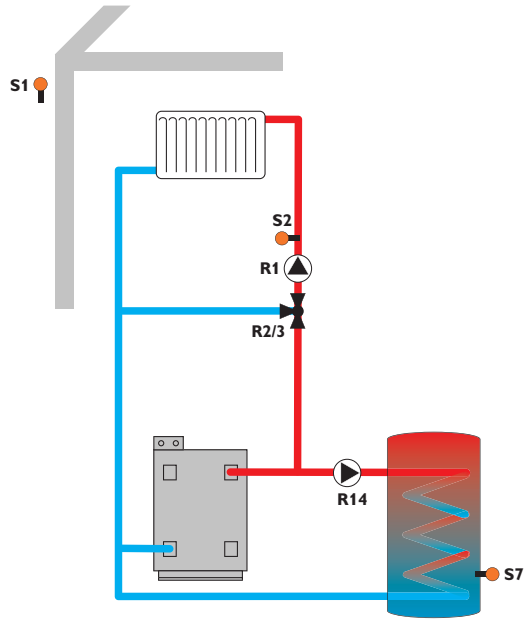

By means of the flow sensor S2 and the outdoor temperature sensor S1, a mixed weather-compensated heating circuit can be controlled. DHW heating is triggered depending on the value measured at the DHW sensor S7.

Scheme no.	0104	0204	0304	0404
Sensors				
S1	Outdoor	Outdoor	Outdoor	Outdoor
S2	Flow HC1	Flow HC1	Flow HC1	Flow HC1
S3		Flow HC2	Flow HC2	Flow HC2
S4			Flow HC3	Flow HC3
S5				Flow HC4
S6				
S7	DHW heating	DHW heating	DHW heating	DHW heating
S8				
S9				
S10				
S11				
S12				
Relay				
R1	Pump HC1	Pump HC1	Pump HC1	Pump HC1
R2	Mixer open HC1	Mixer open HC1	Mixer open HC1	Mixer open HC1
R3	Mixer closed HC1	Mixer closed HC1	Mixer closed HC1	Mixer closed HC1
R4		Pump HC2	Pump HC2	Pump HC2
R5		Mixer open HC2	Mixer open HC2	Mixer open HC2
R6		Mixer closed HC2	Mixer closed HC2	Mixer closed HC2
R7			Pump HC3	Pump HC3
R8			Mixer open HC3	Mixer open HC3
R9			Mixer closed HC3	Mixer closed HC3
R10				Pump HC4
R11				Mixer open HC4
R12				Mixer closed HC4
R13				
R14	DHW heating	DHW heating	DHW heating	DHW heating

Scheme 5: 1 mixed heating circuit with DHW heating and backup heating (demand for heating circuit and DHW)

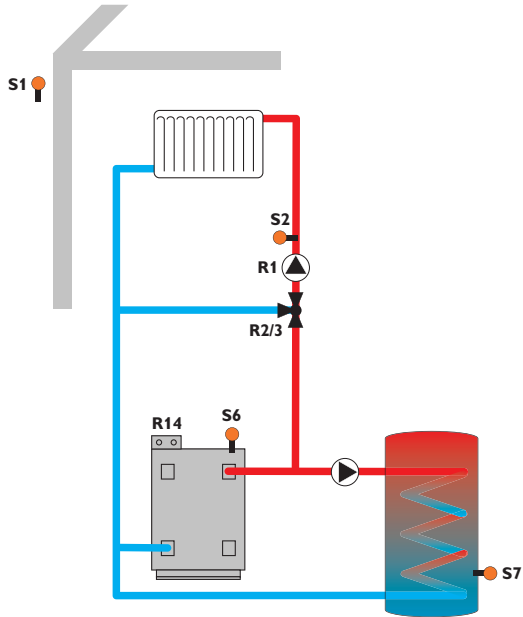

By means of the flow sensor S2 and the outdoor temperature sensor S1, a mixed weather-compensated heating circuit can be controlled. DHW heating is triggered depending on the value measured at the DHW sensor S7. Boiler demand via the potential-free relay is triggered depending on the temperature difference between the set flow temperature and the value measured at the backup heating sensor S6. Boiler demand can also be triggered by the temperature difference between the DHW set temperature and the backup heating sensor S6.

Scheme no.	0105	0205	0305	0405
Sensors				
S1	Outdoor	Outdoor	Outdoor	Outdoor
S2	Flow HC1	Flow HC1	Flow HC1	Flow HC1
S3		Flow HC2	Flow HC2	Flow HC2
S4			Flow HC3	Flow HC3
S5				Flow HC4
S6	BH HC1	BH HC1,2	BH HC1,2,3	BH HC1,2,3,4
S7	DHW heating	DHW heating	DHW heating	DHW heating
S8				
S9				
S10				
S11				
S12				
Relay				
R1	Pump HC1	Pump HC1	Pump HC1	Pump HC1
R2	Mixer open HC1	Mixer open HC1	Mixer open HC1	Mixer open HC1
R3	Mixer closed HC1	Mixer closed HC1	Mixer closed HC1	Mixer closed HC1
R4		Pump HC2	Pump HC2	Pump HC2
R5		Mixer open HC2	Mixer open HC2	Mixer open HC2
R6		Mixer closed HC2	Mixer closed HC2	Mixer closed HC2
R7			Pump HC3	Pump HC3
R8			Mixer open HC3	Mixer open HC3
R9			Mixer closed HC3	Mixer closed HC3
R10				Pump HC4
R11				Mixer open HC4
R12				Mixer closed HC4
R13				
R14	DHW heating, BH HC1	DHW heating, BH HC1,2	DHW heating, BH HC1,2,3	DHW heating, BH HC1,2,3,4

Scheme 6: 1 mixed and 1 unmixed heating circuit

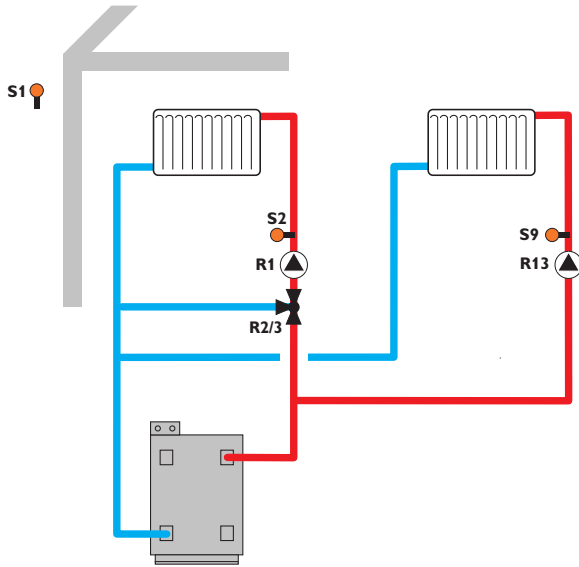

By means of the flow sensors S2 and S9 and the outdoor temperature sensor S1, a mixed and an unmixed weather-compensated heating circuit can be controlled.

Scheme no.	0106	0206	0306	0406
Sensors				
S1	Outdoor	Outdoor	Outdoor	Outdoor
S2	Flow HC1	Flow HC1	Flow HC1	Flow HC1
S3		Flow HC2	Flow HC2	Flow HC2
S4			Flow HC3	Flow HC3
S5				Flow HC4
S6				
S7				
S8				
S9	Flow HC5	Flow HC5	Flow HC5	Flow HC5
S10				
S11				
S12				
Relay				
R1	Pump HC1	Pump HC1	Pump HC1	Pump HC1
R2	Mixer open HC1	Mixer open HC1	Mixer open HC1	Mixer open HC1
R3	Mixer closed HC1	Mixer closed HC1	Mixer closed HC1	Mixer closed HC1
R4		Pump HC2	Pump HC2	Pump HC2
R5		Mixer open HC2	Mixer open HC2	Mixer open HC2
R6		Mixer closed HC2	Mixer closed HC2	Mixer closed HC2
R7			Pump HC3	Pump HC3
R8			Mixer open HC3	Mixer open HC3
R9			Mixer closed HC3	Mixer closed HC3
R10				Pump HC4
R11				Mixer open HC4
R12				Mixer closed HC4
R13	Pump HC5	Pump HC5	Pump HC5	Pump HC5
R14				

Scheme 7: 1 mixed and 1 unmixed heating circuit with backup heating (demand)

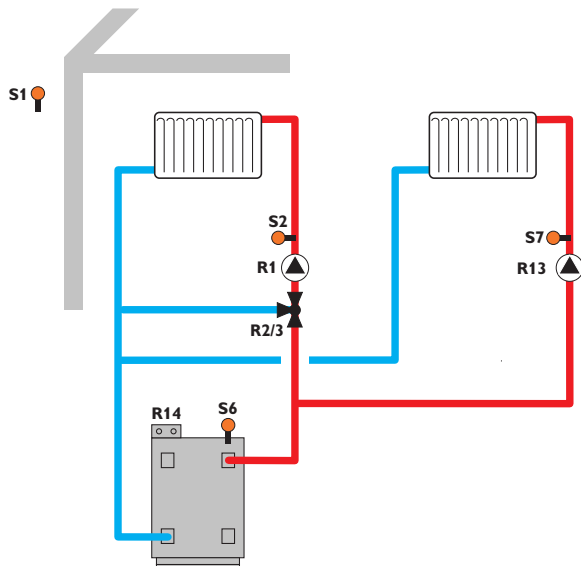

By means of the flow sensors S2 and S7 and the outdoor temperature sensor S1, a mixed and an unmixed weather-compensated heating circuit can be controlled. Boiler demand via the potential-free relay is triggered depending on the temperature difference between the set flow temperatures and the value measured at the backup heating sensor S6.

Scheme no.	0107	0207	0307	0407
Sensors				
S1	Outdoor	Outdoor	Outdoor	Outdoor
S2	Flow HC1	Flow HC1	Flow HC1	Flow HC1
S3		Flow HC2	Flow HC2	Flow HC2
S4			Flow HC3	Flow HC3
S5				Flow HC4
S6	BH HC1,5	BH HC1,2,5	BH HC1,2,3,5	BH HC1,2,3,4,5
S7	Flow HC5	Flow HC5	Flow HC5	Flow HC5
S8				
S9				
S10				
S11				
S12				
Relay				
R1	Pump HC1	Pump HC1	Pump HC1	Pump HC1
R2	Mixer open HC1	Mixer open HC1	Mixer open HC1	Mixer open HC1
R3	Mixer closed HC1	Mixer closed HC1	Mixer closed HC1	Mixer closed HC1
R4		Pump HC2	Pump HC2	Pump HC2
R5		Mixer open HC2	Mixer open HC2	Mixer open HC2
R6		Mixer closed HC2	Mixer closed HC2	Mixer closed HC2
R7			Pump HC3	Pump HC3
R8			Mixer open HC3	Mixer open HC3
R9			Mixer closed HC3	Mixer closed HC3
R10				Pump HC4
R11				Mixer open HC4
R12				Mixer closed HC4
R13	Pump HC5	Pump HC5	Pump HC5	Pump HC5
R14	BH HC1,5	BH HC1,2,5	BH HC1,2,3,5	BH HC1,2,3,4,5

Scheme 8: 1 mixed heating circuit with solid fuel boiler

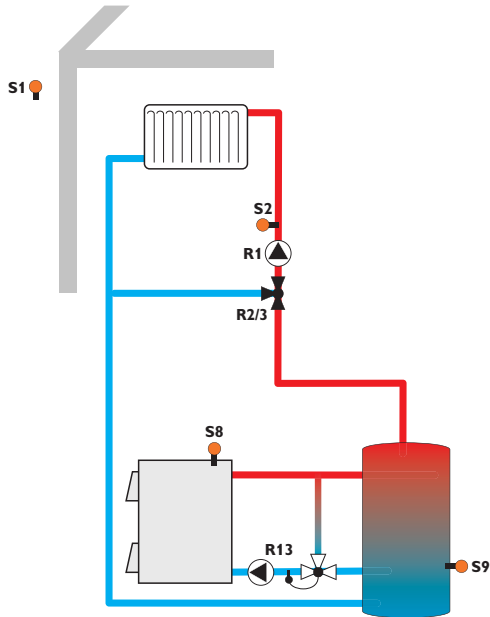

By means of the flow sensor S2 and the outdoor temperature sensor S1, a mixed weather-compensated heating circuit can be controlled. The solid fuel boiler is controlled depending on the temperature difference between the sensors S8 (solid fuel boiler) and S9 (store).

Scheme no.	0108	0208	0308	0408
Sensors				
S1	Outdoor	Outdoor	Outdoor	Outdoor
S2	Flow HC1	Flow HC1	Flow HC1	Flow HC1
S3		Flow HC2	Flow HC2	Flow HC2
S4			Flow HC3	Flow HC3
S5				Flow HC4
S6				
S7				
S8	Boiler SFB	Boiler SFB	Boiler SFB	Boiler SFB
S9	Store SFB	Store SFB	Store SFB	Store SFB
S10				
S11				
S12				
Relay				
R1	Pump HC1	Pump HC1	Pump HC1	Pump HC1
R2	Mixer open HC1	Mixer open HC1	Mixer open HC1	Mixer open HC1
R3	Mixer closed HC1	Mixer closed HC1	Mixer closed HC1	Mixer closed HC1
R4		Pump HC2	Pump HC2	Pump HC2
R5		Mixer open HC2	Mixer open HC2	Mixer open HC2
R6		Mixer closed HC2	Mixer closed HC2	Mixer closed HC2
R7			Pump HC3	Pump HC3
R8			Mixer open HC3	Mixer open HC3
R9			Mixer closed HC3	Mixer closed HC3
R10				Pump HC4
R11				Mixer open HC4
R12				Mixer closed HC4
R13	Pump SFB	Pump SFB	Pump SFB	Pump SFB

R14

Scheme 9: 1 mixed heating circuit with solid fuel boiler and backup heating (demand)

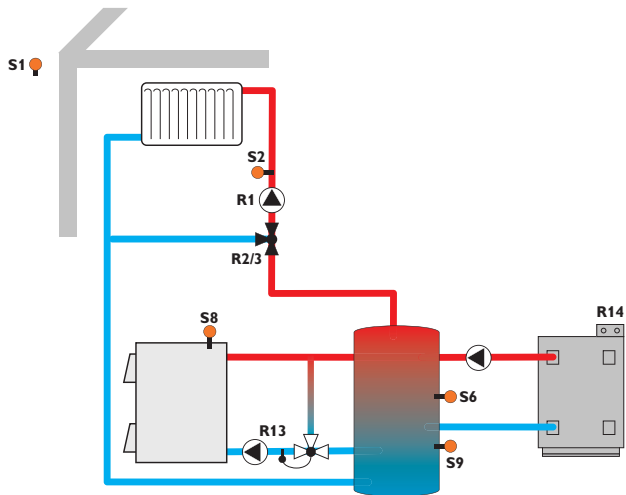

By means of the flow sensor S2 and the outdoor temperature sensor S1, a mixed weather-compensated heating circuit can be controlled. Boiler demand via the potential-free relay is triggered depending on the temperature difference between the set flow temperature and the value measured at the backup heating sensor S6. The solid fuel boiler is controlled depending on the temperature difference between the sensors S8 (solid fuel boiler) and S9 (store).

Scheme no.	0109	0209	0309	0409
Sensors				
S1	Outdoor	Outdoor	Outdoor	Outdoor
S2	Flow HC1	Flow HC1	Flow HC1	Flow HC1
S3		Flow HC2	Flow HC2	Flow HC2
S4			Flow HC3	Flow HC3
S5				Flow HC4
S6	BH HC1	BH HC1,2	BH HC1,2,3	BH HC1,2,3,4
S7				
S8	Boiler SFB	Boiler SFB	Boiler SFB	Boiler SFB
S9	Store SFB	Store SFB	Store SFB	Store SFB
S10				
S11				
S12				
Relay				
R1	Pump HC1	Pump HC1	Pump HC1	Pump HC1
R2	Mixer open HC1	Mixer open HC1	Mixer open HC1	Mixer open HC1
R3	Mixer closed HC1	Mixer closed HC1	Mixer closed HC1	Mixer closed HC1
R4		Pump HC2	Pump HC2	Pump HC2
R5		Mixer open HC2	Mixer open HC2	Mixer open HC2
R6		Mixer closed HC2	Mixer closed HC2	Mixer closed HC2
R7			Pump HC3	Pump HC3
R8			Mixer open HC3	Mixer open HC3
R9			Mixer closed HC3	Mixer closed HC3
R10				Pump HC4
R11				Mixer open HC4
R12				Mixer closed HC4
R13	Pump SFB	Pump SFB	Pump SFB	Pump SFB
R14	BH HC1	BH HC1,2	BH HC1,2,3	BH HC1,2,3,4

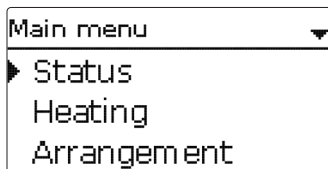

In this menu, different menu areas can be selected.

The following menus are available:

- Status
- Heating
- Arrangement
- HQM
- Basic settings
- SD card
- Manual mode
- User code
- Inputs/Modules

➔ Select the menu area by pressing buttons **1** and **3**.

➔ Press button **5** in order to enter the selected menu area.



Note

If no button is pressed for 1 min, the display illumination switches off. After 4 further minutes, the controller will display the home screen (see page 34).

➔ In order to get from the Status menu into the Main menu, press button **7**.

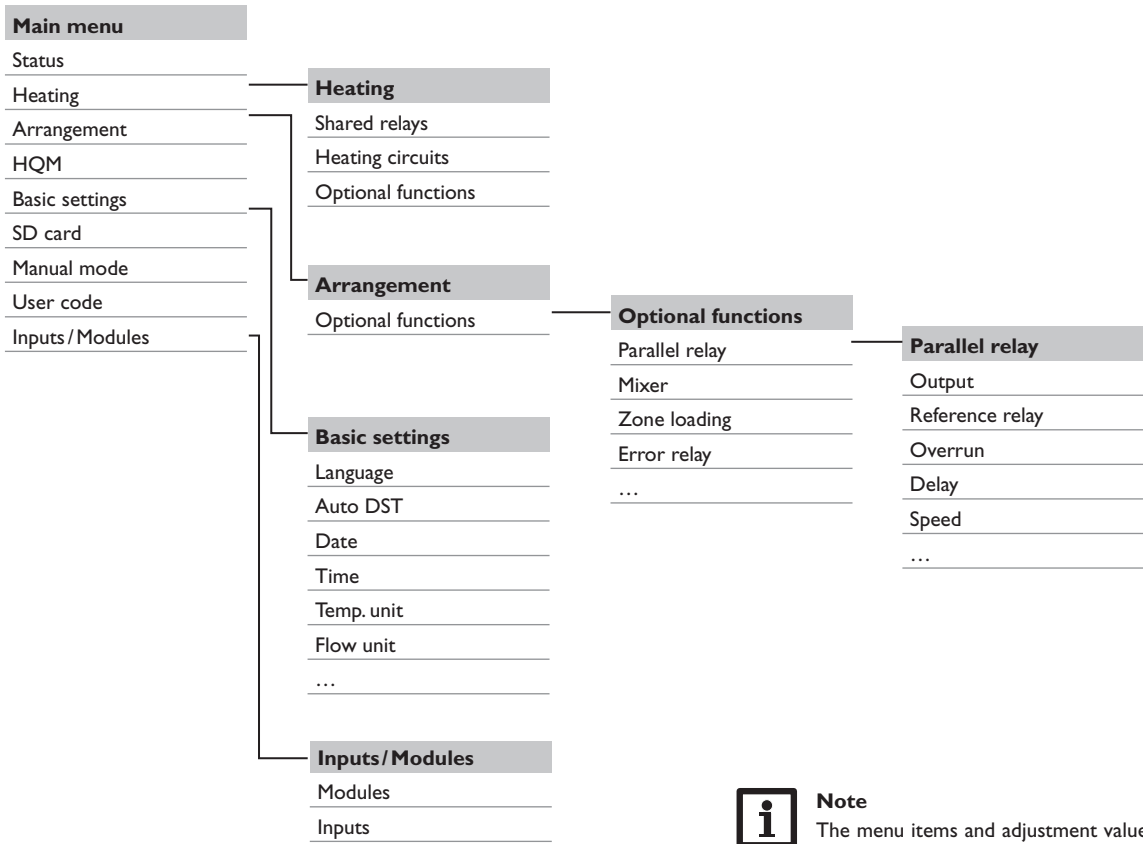



Note

The menu items and adjustment values selectable are variable depending on adjustments already made. The figure only shows an exemplary excerpt of the complete menu in order to visualise the menu structure.

7 Status



In the status menu of the controller, the status messages for every menu area can be found.

Use the buttons  and  for scrolling through the status menu.

HC 1		
▶ Op. mode	Auto	
Status	Day	
Flow	40 °C	

HC 2 static		
▶ Op. mode	Auto	
Status	Summer	
Flow	50 °C	

At the end of each submenu, the menu item **Adjustment values** can be found.



Th. Disinfection		
Duration	23:50	
TDis.	96 °C	
▶ Adj. values		

If **Adjustment values** is selected, the corresponding menu will open.

→ In order to get back to the status menu, press button .

7.1 Measured / Balance values

In the **Status/Meas./Balance values** menu, all current measurement values as well as a range of balance values are displayed. Some of the menu items can be selected in order to enter a submenu.

Each sensor and relay is indicated with the component or function it has been allocated to. The symbol ▶ at the edge of the display next to a sensor allocated to a function, means that this sensor has several functions. Use buttons  and  to scroll to these functions. The sensors and relays of the controller and all modules connected are listed in numerical order.

7.2 Heating

In the **Status / Heating** menu, the status of the demands and heating circuits activated as well as of the selected optional functions is indicated.

7.3 Arrangement

The **Status/Arrangement** menu shows all status information of all activated optional functions of the arrangement.

7.4 HQM

In the **Status / HQM** menu, all current measured values of the flow and return sensors, flow rate and power as well as heat quantities are indicated.



In the **Status / Messages** menu, error and warning messages are indicated.

During normal operation, the message **Everything OK** is indicated.

A message consists of the name of the monitoring function, a 4-digit error code and a short text description of the fault condition.

In order to acknowledge a message, proceed as follows:

- ➔ Select the code line of the desired message by pressing buttons **1** and **3**.
- ➔ Acknowledge the message by pressing button **5**.
- ➔ Confirm the security enquiry by selecting **Yes**.

When the installer user code has been entered, the menu item **Restarts** will appear below the messages. The value indicates the number of controller restarts since commissioning. This value cannot be reset.

Error code	Display	Monitoring function	Cause
0001	!Sensor fault!	Sensor line break	Sensor line broken
0002	!Sensor fault!	Sensor short circuit	Sensor line short-circuited
0061	!Data storage!	Storing and changing adjustments not possible	
0071	!RTC!	Time-controlled functions (e. g. night correction) not possible	
0091	Restarts	Restart counter (non-adjustable)	Number of restarts since commissioning

7.6 Home screen

In the **Home screen** menu, the menu which will appear if no button is pressed for a longer period of time can be selected.

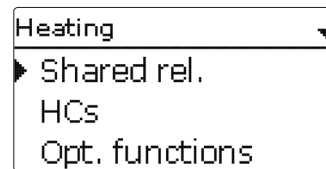

In this menu, all adjustments for the heating part of the arrangement or for the heating circuits respectively can be made.

Shared relays for demands, loading pumps or valves can be activated, heating circuits can be configured and optional functions can be selected and adjusted.

In this menu, the screed drying function can be activated and adjusted.

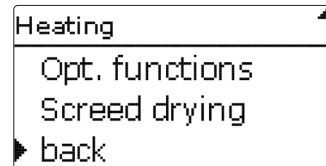

8.1 Shared relays

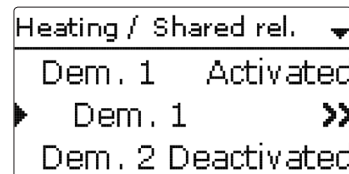

In this menu, adjustments for heat generators which are shared by several heating circuits and their optional functions can be made.

Shared relays will be available for selection under **Virtual** in the heating circuits and in the relay allocation channels of the corresponding optional functions of the Heating menu. This way, several heating circuits and optional functions (heating) can demand the same heat source.



Note

Activate and adjust the shared relays first. They will then be available in the heating circuits and optional functions.

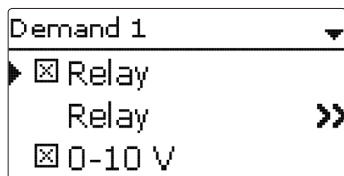

Heating / Shared rel.

Adjustment channel	Description	Adjustment range / selection	Factory setting
Dem. 1 (2)	Demand 1 (2)	Activated, Deactivated	Deactivated
Relay	Relay option	Yes, No	No
Relay	Relay submenu	-	-
Relay	Relay selection	system dependent	system dependent
Boiler pr. min	Option for boiler protection min	Yes, No	No
Tmin	Minimum boiler temperature	10 ... 90 °C	55 °C
Boiler pr. max	Option for boiler protection max	Yes, No	No
Tmax	Maximum boiler temperature	20 ... 95 °C	90 °C
Sen. boiler	Boiler sensor selection	system dependent	S4
0-10V	0-10V option	Yes, No	No
0-10V	0-10V submenu	-	-
Output	Output selection	-, A, B, C, D	-
TSet 1	Lower boiler temperature	10 ... 85 °C	10 °C
Volt 1	Lower voltage	1.0 ... 10.0V	1.0V
TSet 2	Upper boiler temperature	15 ... 90 °C	80 °C
Volt 2	Upper voltage	1.0 ... 10.0V	8.0V
Tmin	Minimum value set boiler temperature	10 ... 89 °C	10 °C
Tmax	Maximum value set boiler temperature	11 ... 90 °C	80 °C
ΔTFlow	Increase for the set flow temperature	0 ... 20K	5K
Sen. flow	Flow sensor option	Yes, No	No

Adjustment channel	Description	Adjustment range / selection	Factory setting
Sensor	Flow sensor selection	system dependent	S4
Interval	Monitoring period	10 ... 600 s	30 s
Hyst.	Correction hysteresis	0.5 ... 20.0K	1.0K
Correction	Correction of the voltage signal	0.0 ... 1.0V	0.1V
Min. runt.	Minimum runtime option	Yes, No	No
tMin	Minimum runtime	0 ... 120 min	10 min
Manual mode	Operating mode for shared relays	Max, Auto, Off, Min	Auto

back

In this menu, up to 2 heating demands can be activated and adjusted.

Activated demands will be available for selection in the output allocation channels of the backup heating in heating circuits and heating optional functions. This way, several heating circuits and optional functions can demand the same heat source.

Every demand can be carried out by means of a relay and/or a 0-10V output. If both the relay and the 0-10V option are activated, the demand will use both outputs in parallel.

Relay option

If the **Relay** option is activated, the submenu **Relay** will appear, in which a relay can be allocated to the demand.

The options **Boiler protection min** and **Boiler protection max** can be activated for the demand via a relay, allowing temperature-dependent control of the boiler demand. For this purpose, a **Boiler sensor** has to be selected.

The **Boiler protection min** option is used for protecting an older type boiler against cooling. If the temperature falls below the adjusted minimum temperature, the allocated relay will be energised until the minimum temperature is exceeded by 5 K.

The **Boiler protection max** option is used for protecting an older type boiler against overheating. If the adjusted Maximum temperature is exceeded, the allocated relay will be switched off until the temperature falls by 5K below the maximum temperature.

Example:

The potential-free relay R14 can be allocated to the shared relay **Demand 1**. R14 will then become available for potential-free boiler demand in the heating circuits and e. g. the DHW heating function.

0-10V option

If the **0-10V** option is activated, the submenu 0-10V will appear, in which a 0-10V output can be allocated to the demand.

With this option, the controller can demand modulating heat generators equipped with a 0-10V interface.

The characteristic curve of the 0-10V signal as a function of the set boiler temperature is defined by means of 2 set points according to the specifications of the boiler manufacturer. At a temperature of **Tset 1**, the voltage signal of the heat generator is **Volt 1**. At a temperature of **Tset 2**, the voltage signal of the heat generator is **Volt 2**. The controller automatically calculates the characteristic curve resulting from these values.

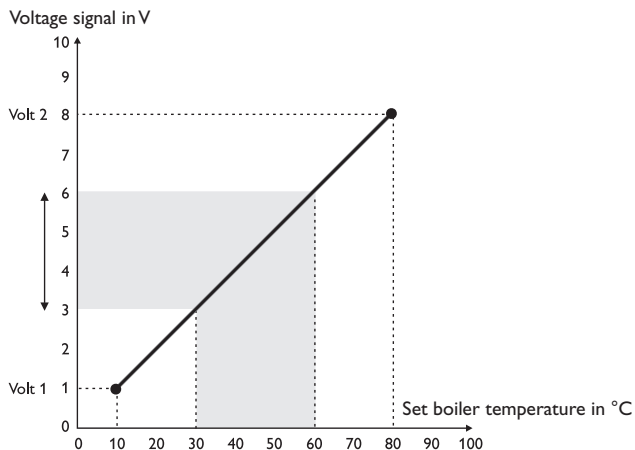

By means of the adjustment channels **Tmax** and **Tmin** the maximum and minimum values for the set boiler temperature can be defined.

When the **Sensor flow** option is activated, the controller will monitor whether the heat generator actually reaches the desired set temperature and will, if necessary, adjust the voltage signal accordingly. In order to do so, the controller will check the temperature at the boiler flow sensor when the **Interval** has elapsed. If the temperature measured deviates from the boiler set temperature by more than the **Hysteresis** value, the voltage signal will be adapted by the **Correction** value. This process will be repeated until the temperature measured is identical to the set

boiler temperature.

When the **Min. runtime** option is activated, a **Minimum runtime** can be adjusted for the demand.



Note

If the 0-10V demand is used for DHW heating, the voltage signal will always be identical to **Tmax**.

8.2 Heating circuits

The controller has 4 mixed weather-compensated heating circuits and is able to control up to 3 external mixed heating circuits by means of extension modules.

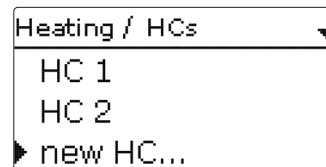

If one or more extension modules are connected, they have to be registered with the controller. Only registered modules will be available in the heating circuit selection.

If **New HC...** is selected for the first time, the first heating circuit is allocated to the controller.

In the heating circuit menu, relays for the heating circuit pump and the heating circuit mixer can be selected.

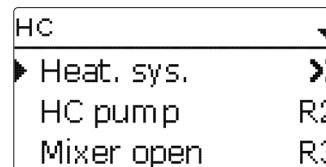

3 free relays are required for a mixed heating circuit.

If the measured flow temperature deviates from the Set flow temperature, the mixer will be activated in order to adjust the flow temperature correspondingly.

The mixer runtime can be adjusted with the parameter **Interval**.

Heating system submenu

In the **Heating system** submenu, a **Mode** for the heating circuit control can be selected and adjusted. 5 modes are available:

- Constant
- Curve
- Linear
- Room influence
- Room

Heat. sys. ▾	
▶ Mode	Constant
Tflowset	45 °C
Tflowmin	20 °C

The **constant** mode aims to keep the set flow temperature at a constant value which can be adjusted by means of the parameter **Tflowset**.

Set flow temperature = set temperature + remote control + day correction or night correction

Heat. sys. ▾	
▶ Mode	Curve
Curve	1.0
Tflowmin	20 °C

If the **Curve** mode is selected, the controller will calculate a set flow temperature by means of the outdoor temperature and the **Heating curve** selected. In both cases, the dial setting of the remote control and the controller Day correction or Night correction will be added.

Set flow temperature = heating curve temperature + remote control + day correction or night correction.

The Remote control allows manual adjustment of the heating curve (± 15 K). Furthermore, the heating circuit can be switched off or a rapid heat-up can be carried out by means of the remote control.

Heating circuit switched off means that the heating circuit pump is switched off and the mixer closed. The flow temperature is boosted to maximum for rapid heat-up when the remote control is set to rapid heat-up.

The calculated set flow temperature is limited by the adjusted values of the parameters **maximum flow temperature** and **minimum flow temperature**.

Maximum flow temperature \geq set flow temperature \geq minimum flow temperature

If the outdoor temperature sensor is defective, an error message will be indicated. For the duration of this condition, the maximum flow temperature -5 K is assumed as the set flow temperature in the **Curve** and **Linear** mode.

In the **Linear** mode the flow temperature curve will be calculated depending on the outdoor temperature by 2 points. At a temperature of **TOutdoor 1** the set flow temperature is **TFlow 1**. At a temperature of **TOutdoor 2** the set flow temperature is **TFlow 2**. The controller automatically calculates the characteristic curve resulting from these values.

Heat. sys. ▾	
▶ Mode	Linear
TOutdoor 1	20 °C
TFlow 1	20 °C

By means of the adjustment channels **Tflowmax** and **Tflowmin** the maximum and minimum values for the set flow temperature can be defined.

In the **Room influence** mode, the weather-compensated set flow temperature will be expanded by a demand-based room control. The parameter **Room factor** can be used for determining the intensity of the room influence.

The controller will calculate the set flow temperature using the heating system Curve plus the room influence: Set flow temperature = set temperature + remote control + day correction or night correction + room influence.

In order to calculate the deviation of the room temperature from the adjusted set value, at least one sensor-type room thermostat is required. The adjustments can be made in the **Room thermostats** submenu, **Room therm.** (1 ... 5).

Heat. sys. ▾	
▶ Mode	Room infl.
Curve	1.0
Room factor	5

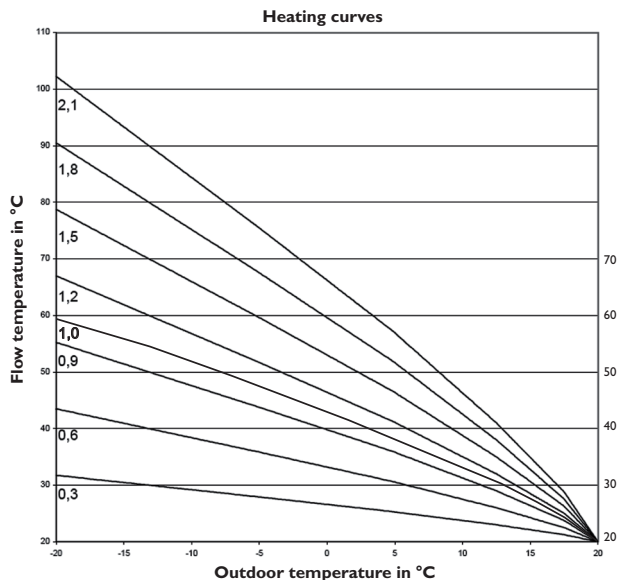

In the **Room** mode, the controller will calculate the set flow temperature by means of the room temperature, the outdoor temperature will not be taken into account.

The parameters **Day-/Night correction** and **Timer** will not be indicated.

The start value of the set flow temperature can be influenced by the parameter **TStart**.

HC	▲
▶ Room therm.	▶▶
<input type="checkbox"/> Backup heating	
<input type="checkbox"/> DHW priority	

In order to calculate the deviation of the room temperature from the adjusted set value, a room thermostat is required. The adjustments can be made using the parameter **RTH(1 ... 5)**. For this purpose, select **Sensor** in the **Type** adjustment channel.

The adjustments of all activated room thermostats will be taken into account. The controller will calculate the average value of the deviations measured and correct the set flow temperature correspondingly.

Room thermostat option

Room thermostats	▼
<input type="checkbox"/> Room therm. 1	
<input type="checkbox"/> Room therm. 2	
▶ <input checked="" type="checkbox"/> Room therm. 3	

With the **Room thermostat** option, up to 5 room thermostats can be integrated into the control logic.

To each room thermostat, a sensor input can be allocated. The temperature at the allocated sensor is monitored. If the measured temperature exceeds the adjusted **Set room temperature** at all activated room thermostats and if the parameter **HC off** is activated, the heating circuit will switch off.

Common room thermostats with potential-free outputs can be used alternatively. In this case, **Switch** must be selected in the **Type** channel. The corresponding input must beforehand be set to **Switch** in the **Inputs / Modules** menu. Only inputs set to **switch** will be displayed in the channel **Sensor RTH** as possible inputs for a switch type room thermostat.

Room thermostats	▲
Type	Sensor
▶ Sensor RTH	S5
Tamb.set	18 °C

When the **Timer** option is activated, a timer is indicated in which time frames for the function can be adjusted. Outside these time frames, the adjusted room temperature is decreased by the **Correction** value.

If the **Special operation Cooling** is active, the **set room temperature** will increase by the **Correction** value.



Note

For information on timer adjustment see page 12.

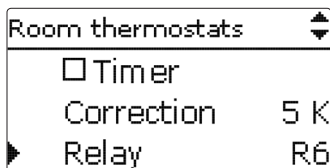

To each room thermostat, an additional relay can be allocated. The relay will switch on when the temperature falls below the adjusted room temperature. This way, the room in question can be excluded from the heating circuit via a valve as long as the desired room temperature is reached.

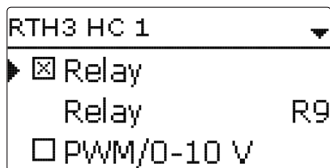

With the parameter **RTH**, the room thermostat can be temporarily deactivated or re-activated respectively. All adjustments remain stored.

Correction timer

With the **Timer**, the day / night operation can be adjusted. During day phases, the set flow temperature is increased by the adjusted **day correction** value, during night phases it is decreased by the **night correction** value (night setback).

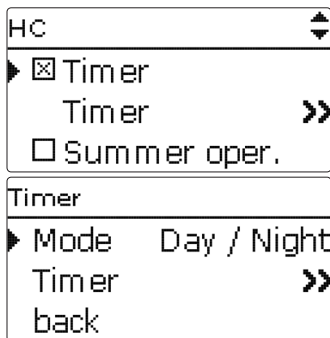

The parameter **Mode** is used for selecting between the following correction modes:

Day / Night: A reduced set flow temperature (night correction) is used during Night operation.

Day / Off: The heating circuit and the optionally activated backup heating are switched off during night operation.

The Timer HC can be used for adjusting the time frames for day operation.

Summer operation

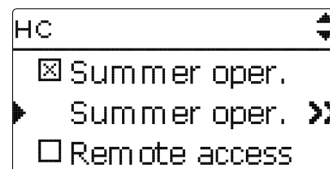

For summer operation, 2 different modes are available:

Day: If the outdoor temperature exceeds the **Summer temperature day**, the heating circuit will switch off.

Day / Night: The parameters **Daytime on** and **Daytime off** can be used for adjusting a time frame for the summer operation. If the outdoor temperature exceeds the **Summer temperature day** within the adjusted time frame, the heating circuit will switch off.

Outside the adjusted time frame the **Summer temperature night** is valid.

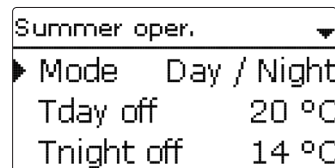

Remote access

With the parameter **Remote access** different types of remote access to the controller can be activated.

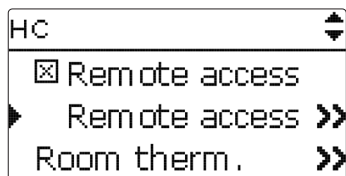

Note

In the sensor selection menu, only outputs which have previously been selected as the input for remote access in the **Inputs / Modules** menu will be available.

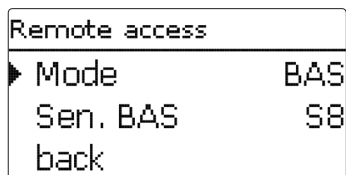

The following types of remote access are possible:

Remote control: A device which allows manual adjustment of the heating curve, thus influencing the set flow temperature.

→ In order to use a remote control, set the **Mode** to **Fern**.

Room control unit: A device incorporating a remote control as well as an additional operating mode switch.

→ In order to use a room control unit, set the **Mode** to **BAS**.

The operating mode switch of the room control unit is used for adjusting the operating mode of the controller. If a room control unit is used, the operating mode can be adjusted by means of the room control unit only. The controller menu will only allow the activation of the operating mode **Holiday**.

App: An app can be used for remote access.

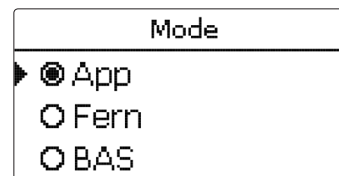

→ In order to use an app, set the **Mode** to **App**.

If you use an app, the operating mode can be adjusted in the controller menu as well as in the app.

Backup heating

For the **Backup heating** of the heating circuit, 3 modes are available:

In the **Therm.** mode, the set flow temperature will be compared to a store reference sensor.

In the **Zone** mode, the set flow temperature will be compared to 2 store reference sensors. The switching conditions have to be fulfilled at both reference sensors.

In the **On/Off** mode, the backup heating will be activated when the heating circuit pump is switched on for heating.

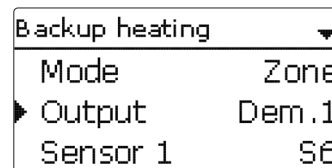

In the **Demand** submenu, the modes **standard** and **Demand** are available. If **Standard** is selected, the output can be adjusted.

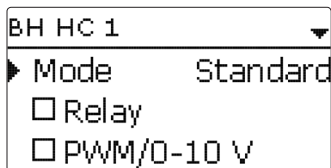

If Demand is selected, a demand has to be activated and adjusted in the **Heating / Shared relays** menu first. If Adjustment values is selected, the **Heating / Shared relays / Demand** menu will open.

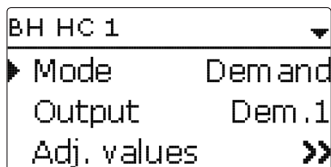

In the correction mode **Day / off** (see page 39) the heating circuit and the backup heating will be completely switched off during the night operation. The **Starting optimisation** option can be used for activating the backup heating before the day operation in order to heat the store to a sufficiently high temperature. The **Stopping optimisation** option can be used for deactivating the backup heating before the start of the night operation.

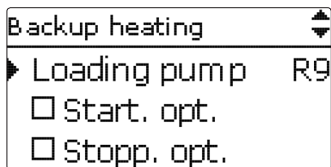

If **SFB off** is activated, backup heating will be suppressed when a selected solid fuel boiler is active.

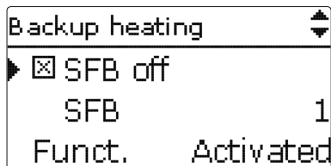

At first, backup heating is activated and can be temporarily deactivated.

DHW priority

If the parameter **DHW priority** is activated, the heating circuit will be switched off and the backup heating be suppressed as long as DHW heating takes place which has previously been activated in the **Heating / Optional functions** menu.

Chimney sweeper function

The chimney sweeper function can be used for enabling a quick access to measurement conditions without menu operation for the chimney sweeper.

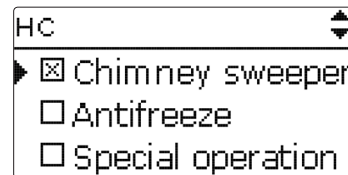

The chimney sweeper function is activated in all heating circuits by default. The chimney sweeper mode can be activated by pressing button for 5 s.

In the chimney sweeper mode, the heating circuit mixer opens, the heating circuit pump and the backup heating contact are activated. While the chimney sweeper mode is active, the directional pad is flashing red. Additionally, **Chimney sweeper** and a countdown of 30 min are indicated on the display.

When the countdown has elapsed, the chimney sweeper mode is automatically deactivated. If, during the countdown, button is again pressed for more than 5 s, the chimney sweeper mode will stop.

Antifreeze function

The antifreeze function of the heating circuit can be used to temporarily activate an inactive heating circuit during sudden temperature drop in order to protect it against frost damage.

The temperature at the sensor selected will be monitored. If the temperature falls below the adjusted antifreeze temperature, the heating circuit will be activated until the antifreeze temperature is exceeded by 2 K, but at least for 30 min.

Special operation

For the **Special operation** option, 2 variants are available:

- Cooling
- Heat dump

Special operation	
Type	Cooling
Output	R11;D
Mode	Outdoor

The **Cooling** variant is used for cooling via the heating circuit. 3 modes are available:

- Outdoor
- External switch
- Both

In the **Outdoor** mode, cooling will be activated if the **outdoor temperature cooling** is exceeded.

In the **External switch** mode, cooling will be activated by means of an external switch.

In the **both** mode, both switching conditions are valid for cooling.

In the **Cooling system** submenu, the cooling logic can be adjusted. For the cooling logic, 2 modes are available:

- Linear
- Constant

In the **Linear** mode, the set flow temperature will be calculated as in the heating system mode **Linear**.

The **Constant** mode aims to keep the set flow temperature at a constant value which can be adjusted by means of the parameter **TFlow**.

If the **Timer** option is activated, a time frame can be adjusted in which the cooling will be active.

If the **Dew point switch** option is activated, an output can be allocated to the dew point switch. If the dew point switch detects condensation, cooling will be interrupted.

Special operation	
Type	Heat dump
Sensor	S7
Ton	85 °C

The **Heat dump** variant is used for diverting excess heat to the heating circuit in order to keep the system temperatures within the operating range. For this purpose, the temperature measured at the allocated sensor **Sensor** will be monitored. If the temperature at the allocated sensor exceeds the **Switch-on temperature**, the **Set flow temperature** will be controlled to reach the adjusted value. If the temperature at the allocated sensor falls below the adjusted **Switch-off temperature**, the heat dump function will switch off.

Energy saving operation

Energy saving	
Sen. Return	S10
ΔToff	4 K
Break	15 min

The **Energy saving operation** is used for optimising the energy consumption of the heating circuit pump. For this purpose an additional sensor in the heating circuit return is required. The controller monitors the temperature difference between the flow and the return of the heating circuit. If the temperature difference falls below the **Switch-off difference**, the controller will deactivate the heating circuit pump for the adjusted **Break time**. After the break time has elapsed, the pump will be activated for the **Runtime**. If the temperature difference is higher than the switch-off difference, the pump will remain active. If the temperature difference is below the switch-off difference, the break time will start again.

Heating / Heating circuits / New HC... / Internal or Module 1 ... 5

Adjustment channel	Description	Adjustment range / selection	Factory setting
Heat. sys.	Heating system submenu	-	-
Mode	Heating system operating mode	Linear, Constant, Curve, Room, Room infl. Curve	
Curve	Heating curve	0.3 ... 3.0	1.0
Room factor	Room influence factor	1 ... 10	5
TFlowset	Set flow temperature	10 ... 90 °C	45 °C
TOutdoor 1	Lower outdoor temperature	-20 ... +20 °C	+20 °C
TFlow 1	Lower set flow temperature	20 ... 90 °C	20 °C
TOutdoor 2	Upper outdoor temperature	-20 ... +20 °C	-20 °C
TFlow 2	Upper set flow temperature	20 ... 90 °C	70 °C
TStart	Start temperature	20 ... 60 °C	40 °C
TFlowmin	Minimum flow temperature	20 ... 89 °C	20 °C
TFlowmax	Maximum flow temperature	21 ... 90 °C	50 °C
Interval	Mixer interval	1 ... 20 s	4 s
HC pump	Heating circuit pump output selection	system dependent	system dependent
Mixer open	Output selection mixer open	system dependent	system dependent
Mixer closed	Output selection mixer closed	system dependent	system dependent
Sen. flow	Flow sensor selection	system dependent	system dependent
Sen. outd.	Outdoor sensor selection	system dependent	system dependent
Day corr.	Correction for day operation	-5 ... +45 K	0 K
Night corr.	Correction for night operation	-20 ... +30 K	-5 K
Timer	Timer option	Yes, No	No
Timer	Timer submenu	-	-
Mode	Correction mode	Day / Night, Day / Off	Day / Night
Summer oper.	Summer operation option	Yes, No	No
Summer oper.	Summer operation submenu	-	-
Mode	Summer operating mode	Day / Night, Day	Day
TDay off	Summer temperature day	0 ... 40 °C	20 °C
TNight off	Summer temperature night	0 ... 40 °C	14 °C
Daytime on	Day time frame on	00:00 ... 23:45	00:00
Daytime off	Day time frame off	00:00 ... 23:45	00:00
Remote access	Remote access option	Yes, No	No

Adjustment channel	Description	Adjustment range / selection	Factory setting
Remote access	Remote access submenu	-	-
Mode	Remote access mode	BAS, Fern, App	BAS
Sen. BAS	Allocation operating mode switch input	all inputs type = BAS	-
Sen. RC	Allocation remote control input	all inputs type = Fern	-
Room therm.	Room thermostats submenu	-	-
Room therm. 1 ... 5	Room thermostat option (1 ... 5)	Yes, No	No
Type	Room thermostat type selection	Sensor, Switch	Sensor
Sensor RTH	RTH input allocation	system dependent	system dependent
TAmb.set	Set room temperature	10 ... 30 °C	18 °C
Hysteresis	RTH hysteresis	0.5 ... 20.0 K	0.5 K
Timer	RTH timer	Yes, No	No
Correction	Correction value	1 ... 20 K	5 K
Relay	RTH relay selection	system dependent	system dependent
RTH	Room thermostat	Activated, Deactivated	Activated
HC off	Heating circuit off option	Yes, No	Yes
Backup heating	Backup heating option	Yes, No	No
Backup heating	Backup heating submenu	-	-
Mode	Backup heating mode selection	Therm., Zone, On/Off	Therm.
Output	Output selection	system dependent	system dependent
Sensor 1	Allocation reference sensor 1	system dependent	system dependent
Sensor 2	Allocation reference sensor 2 (if mode = Zone)	system dependent	system dependent
ΔTon	Switch-on temperature difference	-15.0 ... 44.5 K	5.0 K
ΔToff	Switch-off temperature difference	-14.5 ... 45.0 K	15.0 K
Loading pump	Boiler loading pump option	Yes, No	No
Start. opt.	Starting optimisation option	Yes, No	No
Time	Time starting optimisation	0 ... 300 min	60 min
Stopp. opt.	Stopping optimisation option	Yes, No	No
Time	Time stopping optimisation	0 ... 300 min	60 min
SFB off	Solid fuel boiler off option	Yes, No	No
SFB	Allocation solid fuel boiler	all solid fuel boilers	-

Adjustment channel	Description	Adjustment range / selection	Factory setting
DHW priority	DHW priority option	Yes, No	No
Chimney sweeper	Chimney sweeper option	Yes, No	Yes
Antifreeze	Antifreeze option	Yes, No	No
Sensor	Antifreeze sensor	Flow, Outdoor	Flow
TAntifr.	Antifreeze temperature	-20 ... +10 °C	+5 °C
TFlowset	Set flow temperature antifreeze	20 ... 50 °C	20 °C
Special oper.	Special operation option	Yes, No	No
Special oper.	Special operation submenu	-	-
Type	Special operation variant	Cooling, Heat dump	
Output	Output selection	system dependent	system dependent
Mode	Cooling mode	Outdoor, Ext. switch, Both	-
Sensor	Switch input selection	-	-
Inverted	Inverted switching option	Yes, No	No
TDay off	Outdoor temperature cooling	20 ... 40 °C	20 °C
Cooling system	Cooling system submenu	-	-
Type	Cooling mode	Linear, Constant	Constant
TFlow	Cooling flow temperature	5 ... 25 °C	20 °C
TOutdoor 1	Lower outdoor temperature	15 ... 45 °C	20 °C
TFlow 1	Lower set flow temperature	5 ... 25 °C	20 °C
TOutdoor 2	Upper outdoor temperature	15 ... 45 °C	40 °C
TFlow 2	Upper set flow temperature	5 ... 25 °C	10 °C
Tflowmin	Minimum flow temperature	5 ... 29 °C	10 °C
TFlowmax	Maximum flow temperature	6 ... 30 °C	25 °C
Timer	Timer option cooling	Yes, No	No
tOn	Switch-on time cooling	00:00 ... 23:45	00:00
tOff	Switch-off time cooling	00:00 ... 23:45	00:00
Dew point switch	Dew point switch (DPS) option	Yes, No	No
Sensor	Allocation DPS input	system dependent	system dependent
Output	Output selection	system dependent	system dependent
Sensor	Allocation heat dump sensor	system dependent	system dependent
Ton	Switch-on temperature heat dump	25 ... 95 °C	85 °C
Toff	Switch-off temperature heat dump	20 ... 90 °C	50 °C

Adjustment channel	Description	Adjustment range / selection	Factory setting
TFlowset	Set flow temperature heat dump	5 ... 90 °C	50 °C
Energy saving	Energy saving operation option	Yes, No	No
Energy saving	Energy saving operation submenu	-	-
Sen. return	HC return sensor allocation	system dependent	system dependent
ΔToff	Switch-off temperature difference energy saving operation	1 ... 49 K	4 K
Break	Break time energy saving operation	0 ... 60 min	15 min
Runtime	Runtime energy saving operation	0 ... 60 min	2 min
Funct.	De/activation of the heating circuit	Activated, Deactivated, Switch	Activated
Sensor	Switch input selection	-	-
Save / Delete function	Save or delete function	-	-

8.3 Optional functions

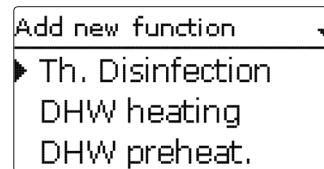

In this menu, optional functions can be selected and adjusted for the heating part of the arrangement.

The kind and number of optional functions offered depends on the previous adjustments.



Note

For further information about adjusting optional functions, see page 14.

In the **Demand** submenu, the modes **standard** and **Demand** are available. If **Standard** is selected, the output can be adjusted. If **Demand** is selected, a demand has to be activated and adjusted in the **Heating/Shared rel.** first. If **Adjustment values** is selected, the **Heating/Shared rel./Demand** will open.



Note

For information on the output selection see page 16.

Thermal disinfection

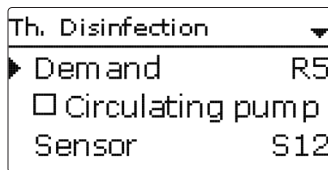

This function helps to contain the spread of Legionella in DHW stores by systematically activating the backup heating.

One **Sensor** and one output or **Demand** respectively can be selected for this function.

For thermal disinfection, the temperature at the allocated sensor has to be monitored. Protection is ensured when, during the **Monitoring period**, the **disinfection temperature** is continuously exceeded for the entire **Disinfection period**.

The monitoring period starts as soon as the temperature at the allocated sensor falls below the disinfection temperature. If the monitoring period ends, the **Demand** will activate the backup heating. The Disinfection period starts when the temperature at the allocated Sensor exceeds the disinfection temperature.

Thermal disinfection can only be completed when the Disinfection temperature is exceeded for the duration of the Disinfection period without any interruption.

The parameter **Cancellation** is used for adjusting the period after which the non-completed backup heating will be cancelled. If the backup heating is cancelled, an error message will be displayed.

Starting time delay

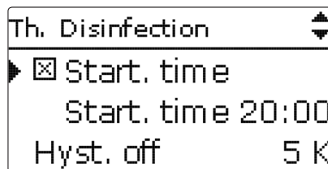

If the **Starting delay** option is activated, a starting time for the thermal disinfection with starting delay can be adjusted. The activation of the backup heating is then delayed until that starting time after the monitoring period has ended.

If the monitoring period ends, for example, at 12:00 o'clock, and the starting time has been set to 18:00, the reference relay will be energised with a delay of 6 hours at 18:00 instead of 12:00 o'clock.

Heating / Opt. functions / Add new function / Th. Disinfection

Adjustment channel	Description	Adjustment range / selection	Factory setting
Demand	Demand relay selection	system dependent	system dependent
Circulating pump	Circulating pump option	Yes, No	No
Output	Circulating pump output selection	system dependent	system dependent
Sensor	Disinfection sensor selection	system dependent	system dependent
Interval	Monitoring period	0 ... 30, 1 ... 23 (dd:hh)	1d 0h
Temperature	Disinfection temperature	45 ... 90 °C	60 °C
Duration	Disinfection period	0.5 ... 24.0 h	1.0 h
Cancellation	Cancellation option	Yes, No	No
Cancellation	Cancellation interval	1.0 ... 48.0 h	2.0 h
Start. time	Starting delay option	Yes, No	No
Start. time	Starting time	00:00 ... 23:30	20:00
Hyst. off	Switch-off hysteresis	2 ... 20 K	5 K
Hyst. on	Switch-on hysteresis	1 ... 19 K	2 K
TD holid. off	Thermal disinfection off when holiday function is active	Yes, No	No
BAS	Operating mode switch option	Yes, No	No
Sensor	Allocation operating mode switch input	system dependent	system dependent
Funct.	Activation / Deactivation	Activated, Deactivated, Switch	Activated
Sensor	Switch input selection	-	-
Save / Delete function	Save or delete function	-	-

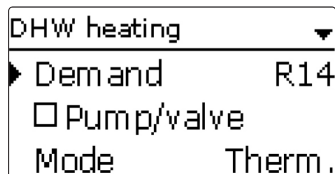

The **DHW heating** is used for demanding a backup heating for heating the DHW store.

If the **Pump / valve** option is activated, another adjustment channel appears, in which an Output can be allocated to the **Pump/valve**. The allocated output will switch on and off with the demand relay.

If the **Overrun time** option is activated, another adjustment channel appears, in which the **overrun time** can be adjusted. If the overrun time option is activated, the loading pump relay will remain switched on for the adjusted duration after the demand relay has been switched off.

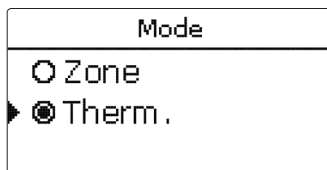

For the DHW heating, 2 modes are available:

Thermal mode

The allocated demand relay will be switched on when the temperature at the allocated **Sensor 1** falls below the adjusted switch-on temperature. If the temperature at the allocated sensor 1 exceeds the adjusted switch-off temperature, the relay will be switched off.

Zone mode

If the zone mode has been selected, another sensor can be allocated in the channel **Sensor 2**. The switch-on, or the switch-off conditions respectively, then have to be fulfilled at both sensors in order for the output to be switched on or off.

When the **Timer** option is activated, a timer is indicated in which time frames for the function can be adjusted.

If **SFB off** is activated, DHW heating will be suppressed when a selected solid fuel boiler is active.

With the **Manual heating** option, DHW heating can be activated outside the adjusted time frame once by means of a switch, if the temperature has fallen below the switch-off value.



Note

For information on timer adjustment see page 12.

With the **BAS off** option, DHW heating can be switched from automatic mode to off by means of the operating mode switch.

Heating / Opt. functions / Add new function / DHW heating

Adjustment channel	Description	Adjustment range / selection	Factory setting
Demand	Output selection demand	system dependent	-
Pump/valve	Loading pump/valve option	Yes, No	No
Output	Output selection loading pump	system dependent	-
Overrun time	Overrun option	Yes, No	No
Duration	Overrun time	1 ... 10 min	1 min
Mode	Operating mode	Zone, Therm.	Therm.
Sensor 1	Allocation reference sensor 1	system dependent	system dependent
Sensor 2	Allocation reference sensor 2 (if mode = Zone)	system dependent	system dependent
Ton	Switch-on temperature	0 ... 94 °C	40 °C
Toff	Switch-off temperature	1 ... 95 °C	45 °C
Timer	Timer option	Yes, No	No
Timer	Timer	-	-
Man. heating	Manual heating option	Yes, No	No
Sensor	Switch input selection	system dependent	system dependent
DHW hold. off	DHW heating off when holiday function is active	Yes, No	No
BAS off	Operating mode switch off option	Yes, No	No
SFB off	Solid fuel boiler off option	Yes, No	No
SFB	Allocation solid fuel boiler	all solid fuel boilers	-
Funct.	Activation / Deactivation	Activated, Deactivated, Switch	Activated
Sensor	Switch input selection	-	-
Save / Delete function	Save or delete function	-	-

DHW preheating

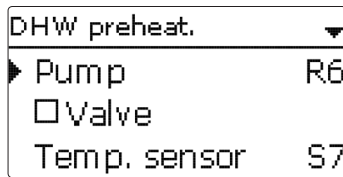

The **DHW preheating** function uses heat from a buffer store to heat the cold water inlet of the DHW store.

The controller monitors the flow rate at the selected **Flow rate sensor**. If a flow rate is detected, the pump will switch on with the **Starting speed**.

If the temperature at the **Temperature sensor** selected exceeds the adjusted **DHW maximum temperature**, the speed will be decreased by the **Increment** value. The interval to the next measurement and adaptation can be adjusted by means of the parameter **Delay**.

If the DHW maximum temperature is not reached after the delay time has elapsed, the speed will be increased by the increment value. The speed will not be increased or decreased respectively within the **Hysteresis**.

If the **ΔT function** is activated, the pump will switch on only if ΔT_{on} is exceeded, and switch off if the temperature difference falls below ΔT_{off} .

If the **Valve** option is activated, the output selected will be activated when the pump is activated.

Heating / Opt. functions / Add new function / DHW preheat.

Adjustment channel	Description	Adjustment range / selection	Factory setting
Pump	Output selection pump	system dependent	-
Valve	Valve option	Yes, No	No
Valve	Output selection valve	system dependent	-
Temp. sensor	Temperature sensor	system dependent	-
Flow rate sen.	Flow rate sensor	IMP1 ... IMP3, Ga1, Ga2, Gd1, Gd2, FR1	-
Tmax. DHW	DHW maximum temperature	20 ... 90 °C	60 °C
Starting speed	Starting speed DHW preheating	20 ... 100 %	50 %
Increment	Increment speed adaptation	1 ... 100 %	10 %
Hysteresis	Hysteresis speed adaptation	0.5 ... 10.0K	5.0K

Adjustment channel	Description	Adjustment range / selection	Factory setting
Delay	Delay time	1 ... 10 s	5 s
ΔT function	Activation ΔT function	Yes, No	No
ΔT_{on}	Switch-on temperature difference	1.0 ... 50.0K	5.0K
ΔT_{off}	Switch-off temperature difference	0.5 ... 49.5K	3.0K
Sen. source	Heat source sensor selection	system dependent	-
Sen. sink	Heat sink sensor selection	system dependent	-
Funct.	Activation / Deactivation	Activated, Deactivated, Switch	Activated
Sensor	Switch input selection	-	-
Save / Delete function	Save or delete function	-	-

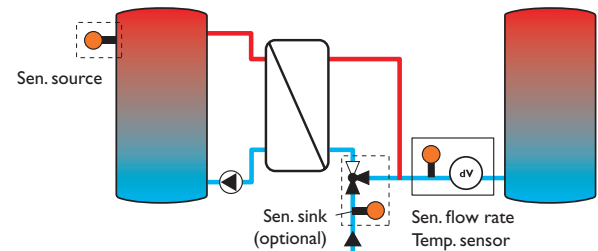

8.4 Scred drying

This function is used for time- and temperature-controlled screed drying in selectable heating circuits.

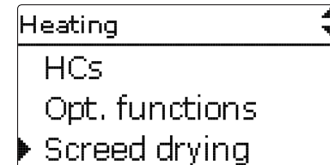

The heating circuits can be selected in the **Heating / Scred drying** menu. At the end of this menu, the function can be triggered by using **Start**.

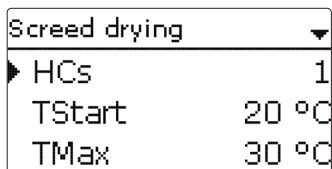

The controller will automatically change to the screed drying status menu. The current **Phase** will be indicated on the display and the **Remaining time** will be indicated as a countdown (dd:hh). During this process, the directional pad is flashing green.

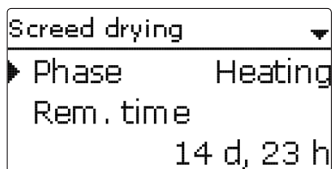

At the end of the menu, **Cancel** will be indicated instead of start. If Cancel is selected, screed drying will be cancelled immediately. For this reason, a security enquiry will appear. If you wish to cancel the screed drying function, confirm the security enquiry.

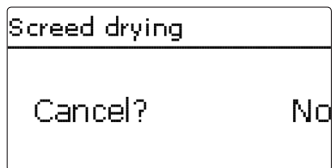

At the beginning of the screed drying function, the heating circuits selected are put into operation for the adjusted **rise time** with the Start temperature as the set flow temperature. Afterwards, the set flow temperature increases in steps by the adjustable Rise value for the duration of the adjustable Rise time until the Holding temperature is reached. After the Holding time has elapsed, the set flow temperature is reduced in steps until the start temperature is reached again.

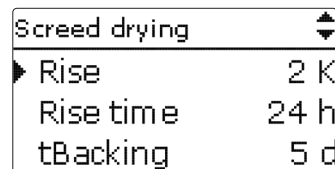

If the set flow temperature is not reached within 24 hours or after the rise time respectively, or if it is constantly exceeded, the screed drying function will be cancelled.

The heating circuit switches off and an error message is displayed. The directional pad glows red.

Error 1: flow sensor defective

Error 2: the flow temperature is higher than the maximum flow temperature + 5 K for over 5 min

Error 3: the flow temperature is higher than the holding temperature + rise value for over 30 min

Error 4: the flow temperature is higher than the set flow temperature + rise value for over 2 h

Error 5: the flow temperature is lower than the set flow temperature - rise value for over a rise time period

During screed drying of the heating circuits selected, the other heating circuits run corresponding to their operating modes.

Button  can be used any time for changing to the status or main menu of the controller in order to carry out adjustments.

When the screed drying function has been successfully completed, the corresponding heating circuits will change to their operating modes selected.

Screed drying will automatically be deactivated. The chimney sweeper function will be activated in all heating circuits.



Note

Make sure the heating circuits are supplied with heat from a heat source (backup heating).



Note

If an SD card has been inserted into the slot, a screed protocol will be generated.

Heating / Screenshot drying

Adjustment channel	Description	Adjustment range / selection	Factory setting
HC	Heating circuit selection	HC1...7	system dependent
TStart	Start temperature	10...30 °C	20 °C
TMax	Holding temperature	20...60 °C	30 °C
Rise	Rise value	1...10K	2K
Rise time	Rise duration	1...24 h	24 h
tBacking	Tmax holding time	1...20 d	5 d
Start	Activation / Deactivation	Yes, No	No

9 Arrangement

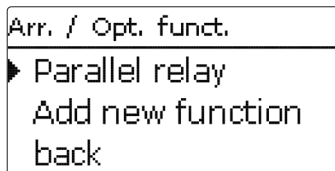

In this menu, all adjustments for the arrangement can be made. Up to 16 optional functions can be selected and adjusted.

9.1 Optional functions

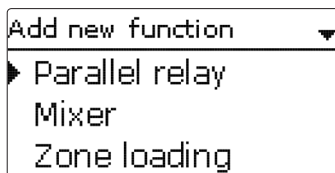

In this menu, optional functions can be selected and adjusted for the arrangement. The kind and number of optional functions offered depends on the previous adjustments.



Note

For further information about adjusting optional functions, see page 14.

Parallel relay

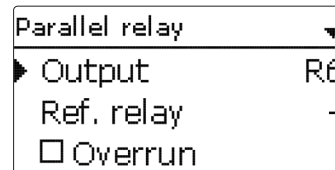

Arrangement / Opt. functions / Add new function / Parallel relay

Adjustment channel	Description	Adjustment range / selection	Factory setting
Output	Output selection	system dependent	system dependent
Ref. relay	Reference relay selection	system dependent	-
Overrun	Overrun option	Yes, No	No
Duration	Overrun time	1...30 min	1 min
Delay	Delay option	Yes, No	No
Duration	Delay time	1...30 min	1 min
Funct.	Activation / Deactivation	Activated, Deactivated, Switch	Activated
Sensor	Switch input selection	-	-
Save / Delete function	Save or delete function	-	-

The **Parallel relay** function can be used for operating an allocated **Output** alongside a selected **Reference relay**. With this function, e. g. a valve can be controlled in parallel to the pump via a separate output.

If the **Overrun** option is activated, the **Output** remains switched on for the adjusted **Overrun time** after the **Reference relay** has been switched off.

If the **Delay** option is activated, the **Output** will be energised after the adjusted **Duration** has elapsed. If the **Reference relay** is switched off again during the delay time, the Parallel output will not be switched on at all.



Note

If a relay is in the manual mode, the selected output will not be energised.

Mixer	
Mixer closed	R5
Mixer open	R10
Sensor	S12

Arrangement / Opt. functions / Add new function / Mixer

Adjustment channel	Description	Adjustment range / selection	Factory setting
Mixer closed	Output selection mixer closed	system dependent	system dependent
Mixer open	Output selection mixer open	system dependent	system dependent
Sensor	Sensor selection	system dependent	system dependent
TMixer	Mixer target temperature	0 ... 130 °C	60 °C
Interval	Mixer interval	1 ... 20 s	4 s
Funct.	Activation / Deactivation	Activated, Deactivated, Switch	Activated
Sensor	Switch input selection	-	-
Save / Delete function	Save or delete function	-	-

The **mixer function** can be used to adjust the actual flow temperature to the desired **mixer target temperature**. The mixer will be opened or closed in pulses depending on this deviation. The mixer will be controlled with the adjustable **Interval**. The pause is determined by the difference between the actual value and the set value.

Zone loading	
Output	R5
Sensor top	S3
Sensor base	S6

Arrangement / Opt. functions / Add new function / Zone loading

Adjustment channel	Description	Adjustment range / selection	Factory setting
Output	Output selection	system dependent	system dependent
Sensor top	Top sensor selection	system dependent	system dependent
Sensor base	Base sensor selection	system dependent	system dependent
Ton	Switch-on temperature	0 ... 94 °C	45 °C
Toff	Switch-off temperature	1 ... 95 °C	60 °C
Timer	Timer option	Yes, No	No
Funct.	Activation / Deactivation	Activated, Deactivated, Switch	Activated
Sensor	Switch input selection	-	-
Save / Delete function	Save or delete function	-	-

The **Zone loading** function can be used for loading a store zone between 2 sensors. For monitoring the switch-on and switch-off conditions, 2 sensors are used. The switch-on and switch-off temperatures are used as reference parameters. If the measured temperatures at both allocated sensors fall below the adjusted **Switch-on temperature**, the output will be energised. The output will be switched off again if the temperature at both sensors has exceeded the **Switch-off temperature**. If one of the two sensors is defective, zone loading is suppressed or switched off.



Note

For information on timer adjustment see page 12.

Error relay

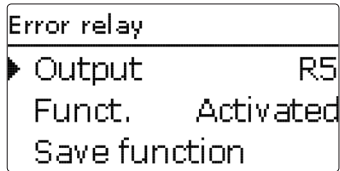

Arrangement / Opt. functions / Add new function / Error relay

Adjustment channel	Description	Adjustment range / selection	Factory setting
Output	Output selection	system dependent	system dependent
Funct.	Activation / Deactivation	Activated, Deactivated, Switch	Activated
Sensor	Switch input selection	-	-
Save / Delete function	Save or delete function	-	-

The **Error relay** function can be used for operating an output in the case of an error. Thus, e. g. a signalling device can be connected in order to signal errors.

If the error relay function is activated, the allocated output will operate when a fault occurs. If the Flow rate monitoring and/or Pressure monitoring function is additionally activated, the allocated Output will also operate in the case of a flow rate or pressure error.

Heat exchange

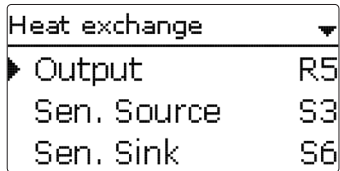

Arrangement / Opt. functions / Add new function / Heat exchange

Adjustment channel	Description	Adjustment range / selection	Factory setting
Output	Output selection	system dependent	system dependent
Sen. source	Heat source sensor selection	system dependent	system dependent
Sen. sink	Heat sink sensor selection	system dependent	system dependent
ΔT_{on}	Switch-on temperature difference	1.0 ... 30.0K	6.0K
ΔT_{off}	Switch-off temperature difference	0.5 ... 29.5K	4.0K

Adjustment channel	Description	Adjustment range / selection	Factory setting
ΔT_{set}	Set temperature difference	1.5 ... 40.0K	10.0K
T_{max}	Maximum temperature of the store to be loaded	10 ... 95 °C	60 °C
T_{min}	Minimum temperature of the store to be loaded	10 ... 95 °C	10 °C
Timer	Timer option	Yes, No	No
Funct.	Activation / Deactivation	Activated, Deactivated, Switch	Activated
Sensor	Switch input selection	-	-
Save / Delete function	Save or delete function	-	-

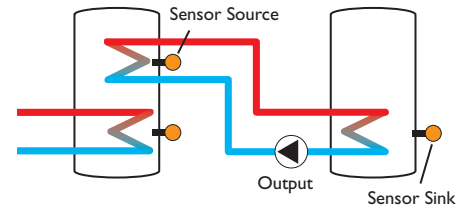

The **Heat exchange** function can be used for transferring heat from a heat source to a heat sink.

The allocated output is energised when all switch-on conditions are fulfilled:

- the temperature difference between the allocated sensors has exceeded the switch-on temperature difference
- the temperature difference between the allocated sensors has not fallen below the switch-off temperature difference
- the temperature at the heat source sensor has exceeded the minimum temperature
- the temperature at the heat sink sensor is below the maximum temperature
- one of the adjusted time frames is active (if the **Timer** option is selected)

If the temperature difference exceeds the adjusted **Set value** by 1/10 of the rise value, the pump speed increases by one step (1 %).

When the **Timer** option is activated, a timer is indicated in which time frames for the function can be adjusted.



Note

For information on timer adjustment see page 12.

Solid fuel boiler

Solid fuel boiler	
Output	R5
Sen. boiler	S3
Sen. store	S6

Arrangement / Opt. functions / Add new function / Solid fuel boiler

Adjustment channel	Description	Adjustment range / selection	Factory setting
Output	Output selection	system dependent	system dependent
Sen. boiler	Solid fuel boiler sensor selection	system dependent	system dependent
Sen. store	Store sensor selection	system dependent	system dependent
ΔT_{on}	Switch-on temperature difference	2.0 ... 30.0K	6.0K
ΔT_{off}	Switch-off temperature difference	1.0 ... 29.0K	4.0K
ΔT_{set}	Set temperature difference	3.0 ... 40.0K	10.0K
TStoremax	Maximum temperature	10 ... 95 °C	60 °C
Tmin boiler	Minimum temperature	10 ... 95 °C	60 °C
Target temp.	Target temperature option	Yes, No	No
Target temp.	Target temperature	30 ... 85 °C	65 °C
Sensor	Target temperature reference sensor	system dependent	system dependent
Mixer	Mixer option	Yes, No	No
Mixer closed	Output selection mixer closed	system dependent	system dependent
Mixer open	Output selection mixer open	system dependent	system dependent
Sensor	Mixer sensor allocation	system dependent	system dependent
ΔT_{open}	Temperature difference mixer open	0.5 ... 30.0K	5.0K
ΔT_{closed}	Temperature difference mixer closed	0.0 ... 29.5K	2.0K
Interval	Mixer interval	1 ... 20 s	4 s
Funct.	Activation / Deactivation	Activated, Deactivated, Switch	Activated
Sensor	Switch input selection	-	-
Save / Delete function	Save or delete function	-	-

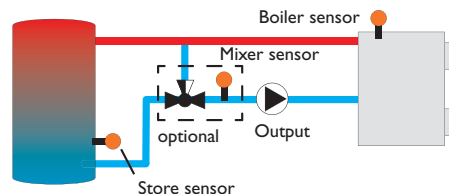

The **Solid fuel boiler** function can be used for transferring heat from a solid fuel boiler to a store.

The allocated output is energised when all switch-on conditions are fulfilled:

- the temperature difference between the allocated sensors has exceeded the switch-on temperature difference
- the temperature difference between the allocated sensors has not fallen below the switch-off temperature difference
- the temperature at the solid fuel boiler sensor has exceeded the minimum temperature
- the temperature at the store sensor is below the maximum temperature
- one of the adjusted time frames is active (if the **Timer** option is selected)

When the **Set temperature difference** is exceeded, pump speed control starts. For every deviation by 1/10 of the adjusted rise value, the pump speed will be adjusted by 1%.

If the **Target temperature** option is activated, the pump speed control logic will change. The controller will remain at the minimum pump speed until the temperature at the allocated **Sensor** exceeds the adjusted **Target temperature**.

The **Mixer** option can be used to keep the boiler return temperature above **Tmin boiler**. The mixer will be controlled with the adjustable **Interval**.

Circulation

Circulation	
Output	R9
Type	Thermal
Sensor	S7

Arrangement / Opt. functions / Add new function / Circulation

Adjustment channel	Description	Adjustment range / selection	Factory setting
Output	Output selection	system dependent	system dependent
Type	Variant	Demand,Thermal,Timer, Therm.+Timer,Demand+-Timer	Thermal
Sensor	Circulation sensor selection	system dependent	system dependent
Ton	Switch-on temperature	10 ... 59 °C	40 °C
Toff	Switch-off temperature	11 ... 60 °C	45 °C
Timer	Timer option	Yes, No	No
Delay	Demand switch-on delay	0 ... 3 s	0 s
Runtime	Circulation pump runtime	01:00 ... 15:00 min	03:00 min
Break time	Circulation pump break time	10 ... 60 min	30 min
Funct.	Activation / Deactivation	Activated, Deactivated, Switch	Activated
Sensor	Switch input selection	-	-
Save / Delete function	Save or delete function	-	-

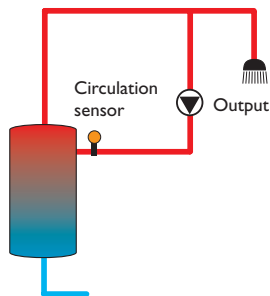

The **Circulation** function can be used for controlling a circulation pump.

For the control logic, 5 variants are available:

- Thermal
- Timer
- Thermal + Timer
- Demand
- Demand + Timer

If one of the variants is selected, the corresponding adjustment channels will appear.

Thermal

The temperature at the allocated Sensor is monitored. The allocated **Output** switches on when the temperature falls below the adjusted **Switch-on temperature**. If the temperature exceeds the **Switch-off temperature**, the output switches off.

Timer

The output switches on during the adjusted time frames, outside of them it switches off.

Thermal + Timer

The output operates when the switch-on conditions of both above-mentioned variants are fulfilled.

Demand

The allocated flow switch is monitored for circuit continuity. If circuit continuity is detected at the flow switch, the output will switch on for the adjusted **Runtime**. After the runtime has ended, the output switches off. During the adjusted **Break time**, the output remains switched off even if continuity is detected at the flow switch.

Demand + Timer

The output operates when the switch-on conditions of both above-mentioned variants are fulfilled. When the **Timer**, **Therm. + Timer** or **Demand + Timer** variant is activated, a timer is indicated in which time frames for the function can be adjusted.



Note

If the flow switch is connected to the input S1 ... S12, continuity must be detected for at least 5 s for the controller to react, 1s if the flow switch is connected to an impulse input.



Note

For information on timer adjustment see page 12.

Return preheating

Ret. preheat.	
Output	R5
Sen. return	S6
Sen. source	S3

Arrangement / Opt. functions / Add new function / Return preheat.

Adjustment channel	Description	Adjustment range / selection	Factory setting
Output	Output selection	system dependent	system dependent
Sen. return	Return sensor selection	system dependent	system dependent
Sen. source	Heat source sensor selection	system dependent	system dependent
ΔT_{on}	Switch-on temperature difference	2.0...30.0K	6.0K
ΔT_{off}	Switch-off temperature difference	1.0...29.0K	4.0K
Summer off	Summer switch-off option	Yes, No	No
Sensor	Outdoor sensor selection	system dependent	system dependent
Toff	Switch-off temperature	10...60°C	20°C
Funct.	Activation / Deactivation	Activated, Deactivated, Switch	Activated
Sensor	Switch input selection	-	-
Save / Delete function	Save or delete function	-	-

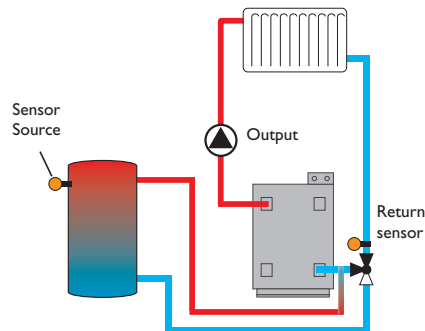

The **Return preheating** function can be used for transferring heat from a heat source to the heating circuit return.

The allocated output is energised when all switch-on conditions are fulfilled:

- the temperature difference between the allocated sensors has exceeded the switch-on temperature difference
- the temperature difference between the allocated sensors has not fallen below the switch-off temperature difference
- if Summer off is activated, the temperature at the outdoor temperature sensor falls below the adjusted outdoor temperature value

With the **Summer switch-off** option, the return preheating can be suppressed outside the heating period.

Function block

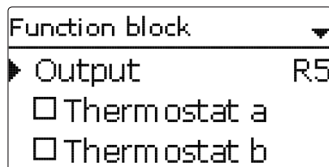

Arrangement / Opt. functions / Add new function / Function block

Adjustment channel	Description	Adjustment range / selection	Factory setting
Output	Output selection	system dependent	system dependent
Thermostat a	Thermostat a option	Yes, No	No
Th-a on	Switch-on temperature thermostat a	-40 ... +250 °C	+40 °C
Th-a off	Switch-off temperature thermostat a	-40 ... +250 °C	+45 °C
Sensor	Sensor thermostat a	system dependent	system dependent
Thermostat b	Thermostat b option	Yes, No	No
Th-b on	Switch-on temperature thermostat b	-40 ... +250 °C	+40 °C
Th-b off	Switch-off temperature thermostat b	-40 ... +250 °C	+45 °C
Sensor	Sensor thermostat b	system dependent	system dependent
ΔT function	Differential function	Yes, No	No
ΔT_{on}	Switch-on temperature difference	1.0 ... 50.0 K	5.0 K
ΔT_{off}	Switch-off temperature difference	0.5 ... 49.5 K	3.0 K
ΔT_{set}	Set temperature difference	3 ... 100 K	10 K
Sen. source	Heat source sensor	system dependent	system dependent
Sen. sink	Heat sink sensor	system dependent	system dependent
Timer	Timer option	Yes, No	No
Ref. output	Reference output option	Yes, No	No
Mode	Reference output mode	OR, AND, NOR, NAND	OR
Output	Reference output 1	all outputs	-
Output	Reference output 2	all outputs	-
Output	Reference output 3	all outputs	-
Output	Reference output 4	all outputs	-
Output	Reference output 5	all outputs	-
Funct.	Activation / Deactivation	Activated, Deactivated, Switch	Activated
Sensor	Switch input selection	-	-
Save / Delete function	Save or delete function	-	-

In addition to the pre-defined optional functions, function blocks consisting of thermostat functions, timer, differential and reference output functions are available. With the help of these function blocks, further components and functions respectively can be controlled.

To each function block, sensors and outputs available can be allocated. Sensors already in use can be allocated again without impeding their control functions.

Within a function block the functions are interconnected (AND gate). This means that the switching conditions of all the activated functions have to be fulfilled for switching the allocated output. As soon as one condition is not fulfilled, the output will switch off.

Thermostat function

The switching condition for the thermostat function is considered fulfilled when the adjusted switch-on temperature ($T_h(x)_{on}$) is reached.

The switching condition for the thermostat function is considered unfulfilled when the adjusted switch-off temperature ($T_h(x)_{off}$) is reached.

Allocate the reference sensor in the **Sensor** channel.

Adjust the maximum temperature limitation with $T_h(x)_{off} > T_h(x)_{on}$ and the minimum temperature limitation with $T_h(x)_{on} > T_h(x)_{off}$. The temperatures cannot be set to an identical value.

ΔT function

The switching condition for the ΔT function is considered fulfilled when the adjusted switch-on temperature (ΔT_{on}) is reached.

The switching condition for the ΔT function is considered unfulfilled when the adjusted switch-off temperature (ΔT_{off}) is reached.

The ΔT function is equipped with a speed control function. A set temperature difference and a minimum speed can be adjusted. The non-adjustable rise value is 2 K.

Reference output

Up to 5 Reference outputs can be selected. Whether the reference outputs are to be switched in series (AND), in parallel (OR), in series + inverted (NAND) or in parallel + inverted (NOR) can be adjusted in the **Mode** channel.

OR mode

If at least one of the reference outputs is switched on, the switching condition for the reference output function is considered fulfilled.

If none of the reference outputs is switched on, the switching condition for the reference output function is considered unfulfilled.

NOR mode

If none of the reference outputs is switched on, the switching condition for the reference output function is considered fulfilled.

If at least one of the reference outputs is switched on, the switching condition for the reference output function is considered unfulfilled.

AND mode

If all reference outputs are switched on, the switching condition for the reference output function is considered fulfilled.

If at least one of the reference outputs is switched off, the switching condition for the reference output function is considered unfulfilled.

NAND mode

If at least one of the reference outputs is switched off, the switching condition for the reference output function is considered fulfilled.

If all reference outputs are switched on, the switching condition for the reference output function is considered unfulfilled.



Note

If more than one function block has been activated, outputs of numerically higher function blocks may not be used as reference outputs.



Note

For information on timer adjustment see page 12.

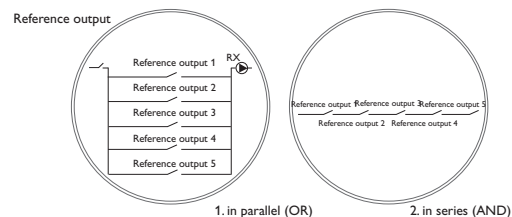
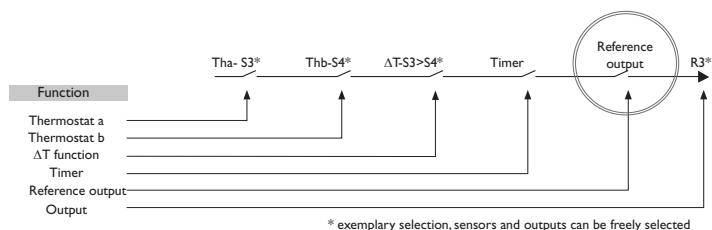

Irradiation switch

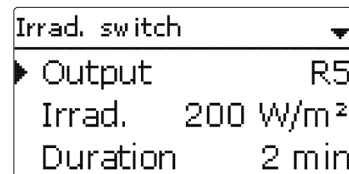

Arrangement / Opt. functions / Add new function / Irrad. switch

Adjustment channel	Description	Adjustment range / selection	Factory setting
Output	Output selection	system dependent	system dependent
Irrad.	Switch-on irradiation	50 ... 1000 W/m ²	200 W/m ²
Duration	Switch-on duration	0 ... 30 min	2 min
Inverted	Inverted switching option	Yes, No	No
Funct.	Activation / Deactivation	Activated, Deactivated, Switch	Activated
Sensor	Switch input selection	-	-
Save / Delete function	Save or delete function	-	-

The **Irradiation switch** function can be used for operating an output depending on the measured irradiation value.

The allocated **Output** will be switched on if the adjusted irradiation value remains exceeded for the adjusted **Duration**. If the irradiation falls below the adjusted irradiation value for the adjusted duration, the output will be switched off.

If the **Inverted** option is activated, the output will operate vice versa.

Return mixing function

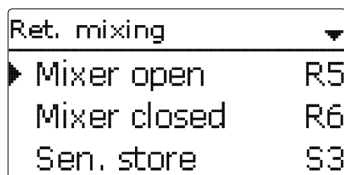

Arrangement / Opt. functions / Add new function / Ret. mixing

Adjustment channel	Description	Adjustment range / selection	Factory setting
Mixer open	Output selection mixer open	system dependent	system dependent
Mixer closed	Output selection mixer closed	system dependent	system dependent
Sen. store	Store sensor allocation	system dependent	system dependent
Sen. HC ret.	HC return sensor allocation	system dependent	system dependent
Sen. boiler ret.	Boiler return sensor allocation	system dependent	system dependent
ΔT_{on}	Switch-on temperature difference	1.0 ... 25.0 K	5.0 K
ΔT_{off}	Switch-off temperature difference	0.5 ... 24.0 K	3.0 K
ΔT_{set}	Set temperature difference	-20 ... +25 K	+7 K
Tmax	Maximum boiler return temperature	10 ... 80 °C	60 °C
Interval	Mixer interval	1 ... 20 s	2 s
HC intern.	Detection controller heating circuit active	Yes, No	No
HC intern.	Heating circuit allocation	HC1 ... HC7	-
Runtime	Mixer runtime	10 ... 600 s	105 s
Time	Time of automatic adjustment	00:00 ... 23:45	00:00
Funct.	Activation / Deactivation	Activated, Deactivated, Switch	Activated
Sensor	Switch input selection	-	-
Save / Delete function	Save or delete function	-	-

The **Return mixing** function can be used for heating backup.

Heat from the store is mixed into the heating circuit return by means of a mixing valve in order to add heat to the heating circuit. The controller compares the temperature in the centre of the store to the heating circuit return temperature. If the store temperature exceeds the heating circuit return temperature by the **Switch-on temperature difference**, the mixer will be used to add heat from the store to the heating circuit return. The mixer will be opened or closed in pulses depending on this deviation. The mixer will be controlled with the adjustable **Interval**. The pause is determined by the difference between the actual value and the set value.

Thus, the heating circuit return temperature is increased by the ΔT_{set} value. The adjustable **Maximum boiler return temperature** limits the mixing temperature. If the store temperature falls below the heating circuit return temperature by the **Switch-off temperature difference**, the mixer will close.

If the mixing temperature exceeds **Tmax** by more than 5 K, a message will appear in the status menu.

The **Runtime** defines the time needed for the mixer to switch from its initial position to the end position. The **Time** defines the point in time when the mixer is set to its initial or ending position respectively.

HC internal option

If the **HC internal** option is activated, the return mixing function will only become active when a selectable heating circuit connected to the same controller is active, too. For this purpose, the heating circuit selected has to be controlled by the controller or by a module connected.

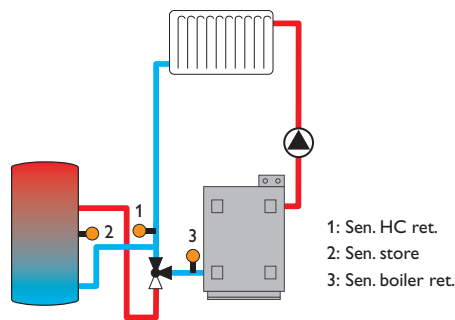

- 1: Sen. HC ret.
- 2: Sen. store
- 3: Sen. boiler ret.

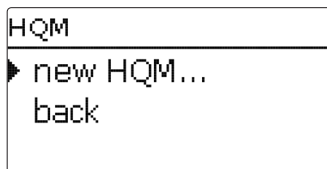

In the **HQM** menu, up to 7 internal heat quantity measurements can be activated and adjusted.

By selecting the menu item **new HQM...**, a new heat quantity measurement can be activated.

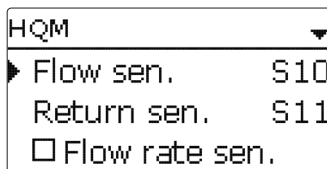

A menu will open in which all adjustments required for the heat quantity measurement can be made.

If the **Flow rate sensor** option is activated, an impulse input or, if available, a Grundfos Direct Sensor™ or a FlowRotor can be selected. The FlowRotor and the Grundfos Direct Sensors™ will only be available if they have been previously registered in the **Inputs / Modules** menu. The impulse rate must be adjusted in that menu as well.

If the **Flow rate sensor** option is deactivated, the controller calculates the heat quantity by means of a fixed flow rate value. This is called heat quantity balancing. For this purpose, the flow rate must be read from the flowmeter at 100% pump speed and adjusted in the adjustment channel **Flow rate**. In addition to that, a **Relay** must be allocated. Heat quantity balancing is in effect whenever the allocated relay is active.

In the adjustment channel **Fluid type**, the heat transfer fluid must be selected. If either Propylene glycol or Ethylene glycol is selected, the adjustment channel **Concentration** is indicated in which the antifreeze ratio of the heat transfer fluid can be adjusted.

If a calorimeter is being configured for the first time or after the overall quantity has been reset, the parameter **Carryover** will appear. A former value which is to be added to the overall quantity, can be entered.

When the **Alternative unit** option is activated, the controller will convert the heat quantity into the quantity of fossil fuels (coal, oil or gas) saved, or the CO₂ emission saved respectively. The alternative **Unit** can be selected. A **Conversion factor** must be adjusted for the calculation. The conversion factor depends on the arrangement in use and has to be determined individually.

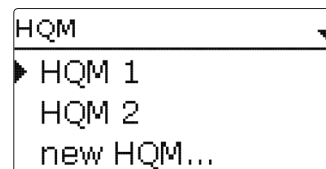

Heat quantity measurements already saved will appear in the HQM menu above the menu item **new HQM...** in numerical order.

If a heat quantity measurement already saved is selected, the above mentioned submenu with all adjustment values will re-open.

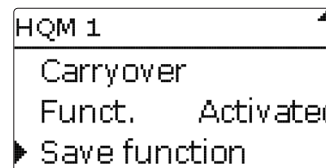

At the end of each HQM submenu, the menu items **Function** and **Save function** are available.

In order to save a heat quantity measurement, select **Save function** and confirm the security enquiry by selecting **Yes**. In heat quantity measurements already saved, the menu item **Delete function** will appear instead.

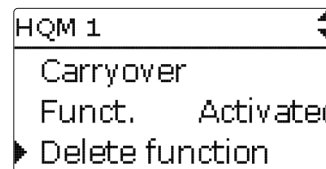

In order to delete a heat quantity measurement already saved, select **Delete function** and confirm the security enquiry by selecting **Yes**. The heat quantity measurement deleted will disappear from the list and become available for selection in the **new HQM...** menu again.

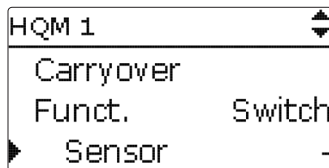

With the menu item **Function**, a heat quantity measurement already saved can be temporarily deactivated or re-activated respectively. In this case, all adjustments will remain stored.

By selecting **Switch**, the heat quantity measurement can be activated or deactivated respectively by means of an external switch. If Switch is selected, the channel **Sensor** will appear. In this channel, the sensor input to which the switch is to be connected can be allocated to the function.

HQM / new HQM...

Adjustment channel	Description	Adjustment range / selection	Factory setting
Sen. flow	Flow sensor selection	system dependent	system dependent
Sen. ret.	Return sensor selection	system dependent	system dependent
Sen. flow rate	Flow rate sensor option	Yes, No	No
Sen. flow rate	Flow rate sensor selection	IMP1 ... IMP3, Ga1, Ga2, Gd1, Gd2, FR1	-
Fl.rate	Flow rate (only if Flow rate sen. = No)	1.0 ... 500.0 l/min	3.0 l/min
Relay	Relay selection	system dependent	-
Fluid type	Heat transfer fluid	Tyfozor LS, Propylene glycol, Ethylene glycol, Water	Water
Concentr.	Glycol concentration in the heat transfer fluid (only if fluid type = propylene glycol or ethylene glycol)	20 ... 70%	40%
Alternative unit	Alternative unit option	Yes, No	No
Carryover	Carryover value (for the first-time configuration or after a HQM reset only)	-	-
Unit	Alternative display unit	Coal, Gas, Oil, CO ₂	CO ₂
Factor	Conversion factor	0.0000001 ... 100.0000000	0.5000000
Funct.	Activation / Deactivation	Activated, Deactivated	Activated

11 Basic settings

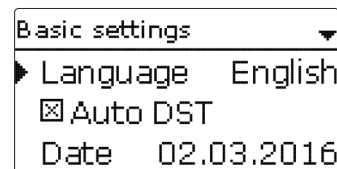

In the **Basic settings** menu, all basic parameters for the controller can be adjusted. Normally, these settings have been made during commissioning. They can be subsequently changed in this menu.

Basic settings

Adjustment channel	Description	Adjustment range / selection	Factory setting
Language	Selection of the menu language	Deutsch, English, Français, Italiano, Español, Nederlands, Suomi	Deutsch
Auto DST	Daylight savings time selection	Yes, No	Yes
Date	Adjustment of the date	01.01.2001 ... 31.12.2099	01.01.2012
Time	Adjustment of the current time	00:00 ... 23:59	-
Temp. unit	Temperature unit	°C, °F	°C
Flow unit	Volume unit	Gallons, Litre	Liter
Press. unit	Pressure unit	psi, bar	bar
Energy unit	Energy unit	Wh, BTU	Wh
Blocking protection	Blocking protection submenu	-	-
Start. time	Blocking protection starting time	00:00 ... 23:59	12:00
Runtime	Blocking protection runtime	1 ... 30 s	10 s
Reset	back to factory setting	Yes, No	No
Scheme	Scheme selection	0000 ... 9999	0000

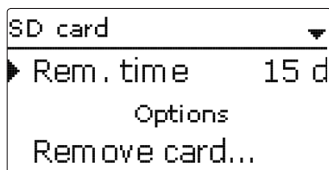

The controller is equipped with an SD card slot for SD memory cards.

With an SD card, the following functions can be carried out:

- Logging measurement and balance values. After the transfer to a computer, the values can be opened and visualised, e. g. in a spreadsheet.
- Store adjustments and parameterisations on the SD card and, if necessary, retrieve them from there.
- Running firmware updates on the controller.

Firmware updates

The current software can be downloaded from www.resol.com/firmware. When an SD card with a firmware update is inserted, the enquiry **Update?** is indicated on the display.

→ To run the update, select **Yes** and confirm by pressing button .

The update will run automatically. The indication **Please wait** and a progress bar will appear on the display. When the update has been completed, the controller will automatically reboot and run a short initialisation phase.



Note

Only remove the card when the initialisation phase has been completed and the main menu is indicated on the controller display!

→ To skip the update, select **No**.

The controller starts normal operation.



Note

The controller will only recognise a firmware update file if it is stored in a folder named **RESOL/HCMX** on the first level of the SD card.

→ Create a folder named **RESOL/HCMX** on the SD card and extract the downloaded ZIP file into this folder.

Starting the logging

→ Insert the SD card into the slot.

→ Adjust the desired logging type and interval.

Logging will start immediately.

Completing the logging process

→ Select the menu item **Remove card**.

→ After **Remove card** is displayed, remove the card from the slot.

When **Linear** is adjusted in the logging type adjustment channel, data logging will stop if the capacity limit is reached. The message **Card full** will be displayed.

If **Cyclic** is adjusted, the oldest data logged onto the SD card will be overwritten as soon as the capacity limit is reached.



Note

Because of the increasing size of the data packets, the remaining logging time does not decrease linearly. The data packet size can increase, e. g. with the increasing operating hours value.

Controller adjustments, storing of

→ To store the controller adjustments on an SD card, select the menu item **Save adjustments**.

While the adjustments are being stored, first **Please wait**, then **Done!** will be indicated on the display. The controller adjustments are stored as a .SET file on the SD card.

Controller adjustments, loading of

→ To load controller adjustments from an SD card, select the menu item **Load adjustments**.

The **File selection** window will appear.

→ Select the desired .SET file.

While the adjustments are being loaded, first **Please wait**, then **Done!** will be indicated on the display.



Note

To safely remove the SD card, always select the menu item **Remove card...** before removing the card.

SD card

Adjustment channel	Description	Adjustment range / selection	Factory setting
Remove card...	Safely remove card	-	-
Save adjustments	Save adjustments	-	-
Load adjustments	Load adjustments	-	-
Logging int.	Logging interval	00:01 ... 20:00 (mm:ss)	01:00
Logging type	Logging type	Cyclic, Linear	Linear

13 Manual mode

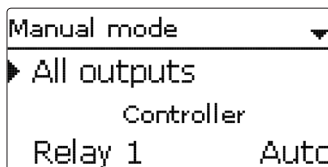

In the **Manual mode** menu, the operating mode of all outputs in the controller and in modules connected can be adjusted.

All outputs are displayed in numerical order, first those of the controller, then those of the individual modules connected. Modules are listed in numerical order.

In the **All outputs...** menu, all outputs can be switched off (Off) or set to automatic mode (Auto) at once:

Off = Output is switched off (manual mode)

Auto = Output is in automatic mode

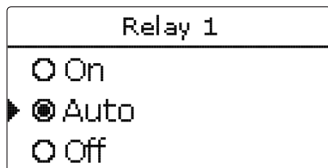

The operating mode can be selected for each individual output, too. The following options are available:

Off = Output is switched off (manual mode)

On = Output is active at 100% speed (manual mode)

Auto = Output is in automatic mode



Note

After service and maintenance work, the operating mode must be set back to **Auto**. Normal operation is not possible in manual mode.

Manual mode

Adjustment channel	Description	Adjustment range / selection	Factory setting
Relay 1 ... X	Operating mode relay	On, Auto, Off	Auto
Output A ... D	Operating mode signal output	On, Auto, Off	Auto
Demand 1 (2)	Operating mode demand	Max, Auto, Min, Off	Auto
all outputs	Selection operating mode of all relays	Auto, Off	Off

14 User code

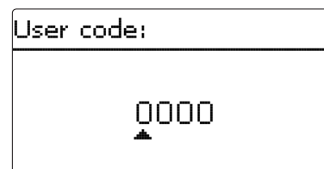

In the **User code** menu, a user code can be entered. Each number of the 4-digit code must be individually adjusted and confirmed. After the last digit has been confirmed, the menu automatically jumps to the superior menu level.

To access the menu areas of the installer level, the installer user code must be entered:

Installer: 0262

For safety reasons, the user code should generally be set to the customer code before the controller is handed to the customer!

Customer: 0000

15 Inputs/Modules

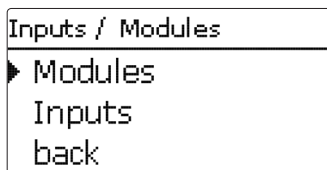

In the **Inputs/Modules** menu, external modules can be registered and sensor offsets be adjusted.

15.1 Modules

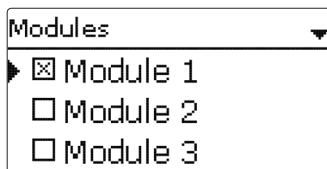

In this menu, up to 5 external modules can be registered.

All modules connected and acknowledged by the controller are available.

→ To register a module, select the corresponding menu item by pressing button **5**.

The checkbox indicates the selection. If a module is registered, all its sensor inputs and relay outputs will be available in the corresponding controller menus.

Inputs/Modules/Modules

Adjustment channel	Description	Adjustment range / selection	Factory setting
Module 1 ... 5	Registering external modules	-	-

15.2 Inputs

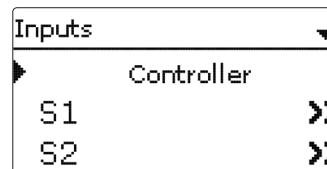

In this submenu, the type of the sensor connected can be adjusted for each individual input. The following types can be selected:

- S1 ... S12: Switch, Fern (remote control), BAS (operating mode switch), Pt1000, Pt500, KTY, None
- S13/IMP1 ... S15/IMP3: Impulse, Switch, Fern (remote control), BAS (operating mode switch), Pt1000, Pt500, KTY, None
- CS10: A ... K
- Ga1, Ga2: RPS, VFS, None
- Gd1, Gd2: RPD, VFD, None
- FR1: DN20, DN25, DN32, None

ATTENTION! System damage!



Selecting the wrong sensor type will lead to unwanted control behaviour. In the worst case, system damage can occur!

→ **Make sure that the right sensor type is selected!**

If **KTY**, **Pt500** or **Pt1000** is selected, the channel **Offset** appears, in which an individual offset can be adjusted for each sensor.

→ In order to select a sensor for the offset adjustment, select the corresponding menu item by pressing button **5**.

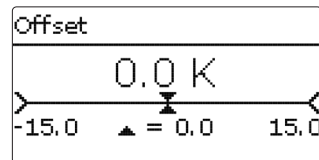

→ To adjust the sensor offset, select the desired value by pressing buttons **2** or **4**, then confirm by pressing button **5**.



Note

If a sensor is used as the temperature sensor of a function, the sensor types **Switch**, **Fern**, **BAS**, **Impulse** and **none** will not be available for the corresponding input.

ATTENTION! Damage to the device!



Sensor inputs which have been set to the sensor type switch can only be used for connecting potential-free switches.

→ **Make sure no voltage is applied!**

If **switch** is selected, the **inverted** option will appear and can be used for inverting the behaviour of the switch.

CS sensor offset

If a CS10 irradiation sensor is to be connected, an offset has to be carried out **before** the connection is made.

To carry out the offset, proceed as follows:

- Adjust the CS type in the **Type** channel.
- Select the **Offset** channel.
- Confirm the **Reset?** enquiry with **Yes**.
- Select **back** to return to the **Inputs** menu, then connect the CS sensor.



Note

When Grundfos Direct Sensors™ are used, connect the sensor ground common terminal block to PE (see page 7).

Inputs/Modules/Inputs

Adjustment channel	Description	Adjustment range / selection	Factory setting
S1 ... S12	Sensor input selection	-	-
Type	Sensor type selection	Switch, Fern, BAS, KTY, Pt500, Pt1000, None	Pt1000
Offset	Sensor offset	-15.0 ... +15.0 K	0.0 K
IMP1 ... IMP3	Impulse input selection	-	-
Type	Sensor type selection	Impulse, Switch, Fern, BAS, KTY, Pt500, Pt1000, None	Impulse
Inverted	Switch inversion (only when Type = Switch)	Yes, No	No

Adjustment channel	Description	Adjustment range / selection	Factory setting
Vol./Imp.	Impulse rate	0.1 ... 100.0 l	1.0 l
CS10	CS10 input	-	-
Type	CS type	A ... K	E
Offset	Delete offset	Yes, No	No
Ga1, 2	Analogue Grundfos Direct Sensor™ 1, 2	-	-
Type	Grundfos-Direct-Sensor™ type	RPS,VFS, None	None
Max.	Maximum pressure (if Type = RPS)	0.0 ... 16.0 bar	6 bar
Min.	Minimum flow rate (if Type = VFS)	1 ... 399 l/min	2 l/min
Max.	Maximum flow rate (if Type = VFS)	2 ... 400 l/min	40 l/min
Gd1, 2	Digital Grundfos Direct Sensor™ 1, 2	-	-
Type	Grundfos-Direct-Sensor™ type	RPD,VFD, None	None
	if Type = VFD: Measuring range selection	10-200 l/min, 5-100 l/min, 2-40 l/min, 2-40 l/min (fast), 1-12 l/min 1-20 l/min, 1-12 l/min*	

* For the Inputs Gd1 and Gd2, the following sensor combinations are possible:

- 1 x RPD, 1 x VFD
- 2 x VFD, but with different measuring ranges only

16 Troubleshooting

If a malfunction occurs, a message will appear on the display of the controller.

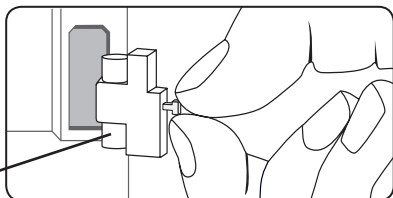

Fuse

Directional pad flashes red.

Sensor fault. The message **!Sensor fault** instead of a temperature is shown on the sensor display channel.

Short circuit or line break.

Disconnected temperature sensors can be checked with an ohmmeter. Please check if the resistance values correspond with the table.

°C	°F	Ω Pt500	Ω Pt1000	Ω KTY	°C	°F	Ω Pt500	Ω Pt1000	Ω KTY
-10	14	481	961	1499	55	131	607	1213	2502
-5	23	490	980	1565	60	140	616	1232	2592
0	32	500	1000	1633	65	149	626	1252	2684
5	41	510	1019	1702	70	158	636	1271	2778
10	50	520	1039	1774	75	167	645	1290	2874
15	59	529	1058	1847	80	176	655	1309	2971
20	68	539	1078	1922	85	185	664	1328	3071
25	77	549	1097	2000	90	194	634	1347	3172
30	86	559	1117	2079	95	203	683	1366	3275
35	95	568	1136	2159	100	212	693	1385	3380
40	104	578	1155	2242	105	221	702	1404	3484
45	113	588	1175	2327	110	230	712	1423	3590
50	122	597	1194	2413	115	239	721	1442	3695

WARNING! Electric shock!



Upon opening the housing, live parts are exposed!

→ **Always disconnect the device from power supply before opening the housing!**

The controller is protected by a fuse. The fuse holder (which also holds the spare fuse) becomes accessible when the cover is removed. To replace the fuse, pull the fuse holder from the base.

The display is permanently off.

Press button (5). Display illuminated?

no

yes

Controller has been in standby, everything OK

Check the power supply of the controller. Is it disconnected?

no

yes

The fuse of the controller could be blown. The fuse holder (which holds the spare fuse) becomes accessible when the cover is removed. The fuse can then be replaced.

Check the supply line and reconnect it.



Note

For answers to frequently asked questions (FAQ) see www.resol.com.

The heating circuit pump does not work, although this is indicated on the status display.

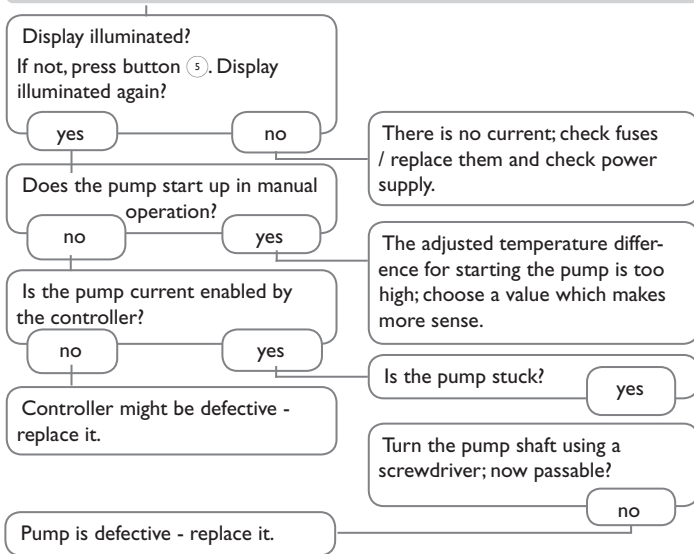

Stores cool down at night.

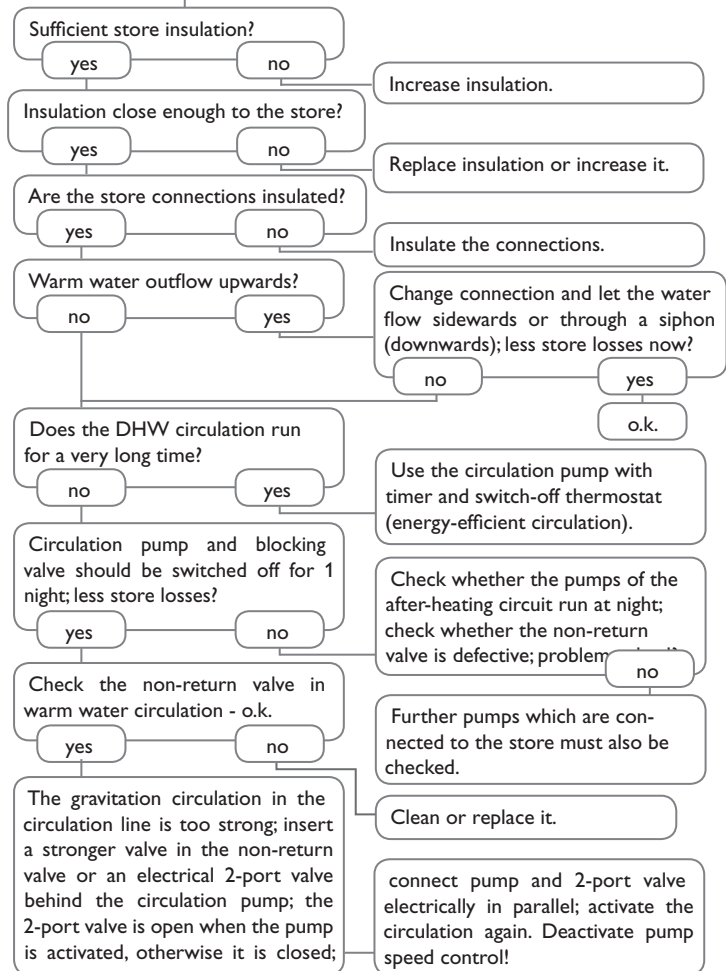



DL3 Datalogger

For visualisation via VBus.net, incl. SD card, mains adapter, network and VBus® cable.



DL2 Datalogger

For visualisation via VBus.net, incl. SD card and network cable, mains adapter and VBus® cable pre-connected.



EM Extension Module

Sensor and relay Extension module with 5 outputs and 6 inputs



TS10 Dew point switch

For condensation detection in a heating circuit used for cooling purposes.



VFS/RPS & VFD/RPD Grundfos Direct Sensors™

Analogue / digital sensors in different versions



V40 Flowmeter

The V40 is a measuring instrument for detecting the flow of water or water/glycol mixtures.



AM1 Alarm module

Alarm module for signalling system failures



SDFK Smart Display

The SDFK Smart Display indicates the solid fuel boiler temperature and the bottom/top store temperatures as well as the pump status.



SP10 Overvoltage protection device

Overvoltage protection device, suitable for mounting outdoors.



VBus®/USB & VBus®/LAN interface adapters

With the VBus® / USB interface adapter, the controller can be connected to the USB port of a PC via the VBus®.

The VBus® / LAN interface adapter is designed for the direct connection of the controller to a PC or router. It enables easy access to the controller via the local network of the owner.



Sensors

The product range includes high-precision platinum temperature sensors, flatscrew sensors, outdoor temperature sensors, indoor temperature sensors, cylindrical clip-on sensors, also as complete sensors with immersion sleeve.



VBus® Touch HC

This easy-to-use app enables you to make adjustments on your RESOL heating controller from a mobile device. Thus, e. g. the operating mode can be set via the app. Additionally, the system data are displayed in a clearly arranged graphic.

VBus® is a registered trademark of RESOL GmbH

Google Play is a trademark of Google Inc.

Apple, the Apple logo, iPad, and iPhone are trademarks of Apple Inc., registered in the U.S. and other countries. App Store is a service mark of Apple Inc.



0-10V boiler control.....	36	F	Function block.....	55
A			Fuse, replacing of.....	64
Antifreeze function.....	41	H		
App.....	40	Heat dump, heating circuit.....	42	
B		Heating circuit mixer.....	36	
Backup heating, heating circuit.....	40	Heating circuit pump.....	36	
Boiler control.....	34	Heating curve.....	37	
C		Heat quantity measurement.....	58	
Chimney sweeper function.....	41	I		
Circulation.....	53	Interval.....	36	
Commissioning menu.....	19	Irradiation switch.....	56	
Condensation detection.....	42	M		
Controller adjustments, loading of.....	60	Manual mode.....	61	
Controller adjustments, storing of.....	60	Maximum flow temperature.....	37	
Cooling via the heating circuit.....	42	Minimum flow temperature.....	37	
Correction modes.....	41	Mixer, optional arrangement function.....	50	
Countdown.....	41	Mixer runtime.....	36	
D		Modulating heating control.....	36	
Data logging.....	60	Modules, registration of.....	62	
Day correction.....	37	Mounting.....	5	
Day/Night operation.....	39	N		
Day operation.....	41	Night correction.....	37	
Dew point switch.....	42	Night operation.....	39	
DHW heating.....	46	O		
DHW preheating.....	47	Offset.....	62	
DHW priority, heating circuit.....	41	Operating mode, outputs.....	61	
E		Operating mode switch.....	40	
Electrical connection.....	7	Output selection.....	16	
Energy saving operation, heating circuit.....	42			
Error messages.....	34			
Error messages, acknowledgement of.....	34			
Error relay.....	51			

R

Registering external modules.....	62
Remote access, heating circuit.....	40
Remote control.....	37, 40
Return mixing function.....	57
Return preheating.....	54
Room control, heating circuit.....	38
Room control unit.....	40
Room influence, heating circuit.....	37
Room thermostat.....	38

S

Screed drying.....	47
Sensor offset.....	62
Set flow temperature.....	37
Shared relays.....	34
Solid fuel boiler.....	52
Special operation, heating circuit.....	42
Starting time.....	41
Start temperature.....	48

T

Technical data.....	4
Thermal disinfection.....	45
Thermostat function.....	55
Timer.....	12

U

User code.....	61
----------------	----

V

VBus.....	8
Virtual.....	34

Z

Zone loading.....	50
-------------------	----

Distributed by:

RESOL – Elektronische Regelungen GmbH

Heiskampstraße 10
45527 Hattingen / Germany
Tel.: +49 (0) 23 24 / 96 48 - 0
Fax: +49 (0) 23 24 / 96 48 - 755

www.resol.com
info@resol.com

Important note

The texts and drawings in this manual are correct to the best of our knowledge. As faults can never be excluded, please note:

Your own calculations and plans, under consideration of the current standards and directions should only be basis for your projects. We do not offer a guarantee for the completeness of the drawings and texts of this manual - they only represent some examples. They can only be used at your own risk. No liability is assumed for incorrect, incomplete or false information and / or the resulting damages.

Note

The design and the specifications can be changed without notice.

The illustrations may differ from the original product.

Imprint

This mounting- and operation manual including all parts is copyrighted. Another use outside the copyright requires the approval of **RESOL – Elektronische Regelungen GmbH**. This especially applies for copies, translations, micro films and the storage into electronic systems.