

# DeltaSol® SLT

Beginning with firmware version 1.04

# RESOL®

## System controller

Manual for the specialised  
craftsman

**Installation**

**Operation**

**Functions and options**

**Troubleshooting**



11215129



The Internet portal for easy and secure access to  
your system data – [www.vbus.net](http://www.vbus.net)

Thank you for buying this RESOL product.  
Please read this manual carefully to get the best performance from this unit.  
Please keep this manual safe.

en

Manual

[www.resol.com](http://www.resol.com)

## Safety advice

Please pay attention to the following safety advice in order to avoid danger and damage to people and property.

Danger of electric shock:

- When carrying out works, the device must first of all be disconnected from the mains.
- It must be possible to disconnect the device from the mains at any time.
- Do not use the device if it is visibly damaged!

The device must not be used by children or persons with reduced physical, sensory or mental abilities or without any experience and knowledge. Make sure that children do not play with the device!

Only connect accessories authorised by the manufacturer to the device.

Make sure that the housing is properly closed before commissioning the device.

Set the code to the customer code before handing over the controller to the customer.

## Target group

These instructions are exclusively addressed to authorised skilled personnel.

Only qualified electricians are allowed to carry out electrical works.

Initial commissioning must be effected by authorised skilled personnel.

Authorised skilled personnel are persons who have theoretical knowledge and experience with the installation, commissioning, operation, maintenance, etc. of electric/electronic devices and hydraulic systems and who have knowledge of relevant standards and directives.

## Instructions

Attention must be paid to the valid local standards, regulations and directives!

**Subject to technical change. Errors excepted.**

## Information about the product

### Proper usage

The system controller is designed for use in solar thermal systems and heating systems in compliance with the technical data specified in this manual.

Any use beyond this is considered improper.

Proper usage also includes compliance with the specifications given in this manual.

Improper use excludes all liability claims.



### Note:

Strong electromagnetic fields can impair the function of the device.

- ➔ Make sure the device as well as the system are not exposed to strong electromagnetic fields.

### EU Declaration of conformity

The product complies with the relevant directives and is therefore labelled with the CE mark. The Declaration of Conformity is available upon request, please contact the manufacturer.



### Scope of delivery

The scope of delivery of this product is indicated on the packaging label.

### Storage and transport

Store the product at an ambient temperature of 0 ... 40 °C and in dry interior rooms only.

Transport the product in its original packaging only.

### Cleaning

Clean the product with a dry cloth. Do not use aggressive cleaning fluids.

### Data security

We recommend regular backups of the data stored on the device via MicroSD card.

## Decommissioning

1. Disconnect the device from the power supply.
2. Dismount the device.

## Disposal

- Dispose of the packaging in an environmentally sound manner.
- At the end of its working life, the product must not be disposed of as urban waste. Old appliances must be disposed of by an authorised body in an environmentally sound manner. Upon request we will take back your old appliances bought from us and guarantee an environmentally sound disposal of the devices.



## Description of symbols

**Warnings are indicated with a warning symbol!**

**Signal words** describe the danger that may occur, when it is not avoided.

**WARNING** means that **injury, possibly life-threatening injury, can occur.**

→ It is indicated how to avoid the danger described.



**ATTENTION** means that **damage to the appliance can occur.**

→ It is indicated how to avoid the danger described.



**Note**

Notes are indicated with an information symbol.

→ Texts marked with an arrow indicate one single instruction step to be carried out.

1. Texts marked with numbers indicate several successive instruction steps to be carried out.

The DeltaSol® SLT effortlessly controls even complex systems. 27 pre-configured system layouts with numerous pre-programmed optional functions such as thermal disinfection or zone loading enable adaptation to the individual system requirements.

The operation via 2 main buttons and 1 adjustment dial, the Lightwheel®, still follows the well-known operating concept. The multicoloured LED, integrated in the Lightwheel®, offers many possibilities to signal different system states. The MicroSD card slot and the 2 microbuttons for quick access to the manual mode and the holiday function are located underneath the slidable housing cover, the Slider.

### Contents

<b>1 Overview .....</b>	<b>5</b>	<b>8 Solar.....</b>	<b>27</b>
<b>2 Installation .....</b>	<b>6</b>	8.1 Basic solar settings.....	27
2.1 Mounting.....	6	8.2 Solar optional functions.....	30
2.2 Electrical connection.....	8	8.3 Holiday function .....	43
2.3 Data communication / Bus.....	9	8.4 Solar expert menu .....	44
2.4 MicroSD card slot.....	9	<b>9 Arrangement .....</b>	<b>44</b>
<b>3 Step-by-step parameterisation .....</b>	<b>10</b>	9.1 Optional functions .....	44
<b>4 Operation and function .....</b>	<b>11</b>	<b>10 Heating.....</b>	<b>53</b>
4.1 Buttons and adjustment dial.....	11	10.1 Demands.....	53
4.2 Microbutton for manual mode and holiday mode.....	11	10.2 Optional functions .....	53
4.3 Control lamp.....	11	<b>11 HQM .....</b>	<b>57</b>
4.4 Selecting menu points and adjusting values .....	11	<b>12 Basic settings .....</b>	<b>58</b>
4.5 Menu structure.....	16	<b>13 MicroSD card .....</b>	<b>59</b>
<b>5 Commissioning.....</b>	<b>17</b>	<b>14 Manual mode .....</b>	<b>60</b>
5.1 Basic systems and hydraulic variants .....	19	<b>15 User code .....</b>	<b>60</b>
5.2 Overview of relay and sensor allocation.....	20	<b>16 In- / Outputs.....</b>	<b>61</b>
<b>6 Main menu .....</b>	<b>24</b>	16.1 Inputs.....	61
<b>7 Status.....</b>	<b>24</b>	16.2 Outputs.....	62
7.1 Meas./ Balance values.....	24	<b>17 Troubleshooting.....</b>	<b>64</b>
7.2 Solar .....	25	<b>18 Accessories .....</b>	<b>67</b>
7.3 Arrangement.....	25	<b>19 Index .....</b>	<b>68</b>
7.4 Heating .....	25		
7.5 Messages .....	25		
7.6 Service.....	27		

## 1 Overview

- 4 relay outputs (incl. 1 extra-low voltage relay)
- 4 inputs for Pt1000, Pt500 or KTY temperature sensors
- Input for 1 analogue Grundfos Direct Sensor™ and 1 frequency input
- 1 V40 impulse input (also usable as a Pt1000, Pt500 or KTY temperature sensor input)
- 2 PWM outputs for speed control of high-efficiency pumps
- MicroSD card slot
- Automatic function control according to VDI 2169

### Dimensions and minimum distances

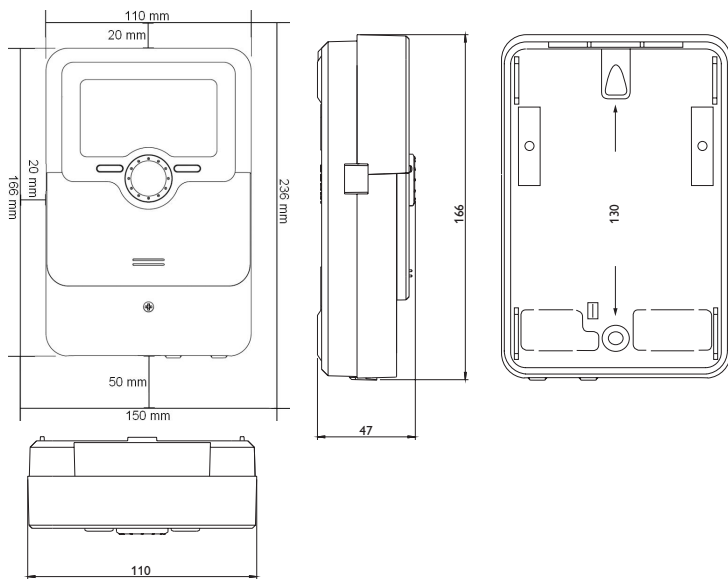

### Technical data

**Inputs:** 4 inputs for Pt1000, Pt500 or KTY temperature sensors, 1 analogue Grundfos Direct Sensor™, 1 frequency input, 1 V40 impulse input (also usable as a Pt1000, Pt500 or KTY temperature sensor input)

**Outputs:** 3 semiconductor relays, 1 potential-free extra-low voltage relay, 2 PWM outputs (switchable to 0-10V)

**PWM frequency:** 512 Hz

**PWM voltage:** 10.8 V

**Switching capacity per relay:**

1 (1) A 240 V~ (semiconductor relay)

1 (1) A 30 V== (potential-free relay)

**Total switching capacity:** 3 A 240 V~

**Power supply:** 100 ... 240 V~ (50 ... 60 Hz)

**Supply connection:** type X attachment

**Standby:** 0.68 W

**Temperature controls class:** I

**Energy efficiency contribution:** 1 %

**Mode of operation:** Typ 1.B.C.Y

**Rated impulse voltage:** 2.5 kV

**Data interface:** VBus®, MicroSD card slot

**VBus® current supply:** 60 mA

**Functions:**  $\Delta T$  control, pump speed control, heat quantity measurement, operating hours counter for the relays, tube collector function, thermostat function, store loading in layers, priority logic, drainback option, booster function, heat dump function, thermal disinfection function, PWM pump control, function control according to VDI 2169.

**Housing:** plastic, PC-ABS and PMMA

**Mounting:** wall mounting, also suitable for mounting into patch panels

**Display:** full graphic display, control lamp (Lightwheel®) and background illumination

**Operation:** 4 push buttons at the front and 1 adjustment dial (Lightwheel®)

**Protection type:** IP 20/DIN EN 60529

**Protection class:** I

**Ambient temperature:** 0 ... 40 °C

**Degree of pollution:** 2

**Fuse:** T4A

**Overvoltage category:** 2

**Maximum altitude:** 2000 m above MSL

**Dimensions:** 110 x 166 x 47 mm

## 2 Installation

### 2.1 Mounting

#### **WARNING! Electric shock!**



Upon opening the housing, live parts are exposed!

→ **Always disconnect the controller from power supply before opening the housing!**



#### **Note:**

Strong electromagnetic fields can impair the function of the device.

→ Make sure the device as well as the system are not exposed to strong electromagnetic fields.

The unit must only be located in dry interior rooms.

If the device is not equipped with a mains connection cable and a plug, the device must additionally be supplied from a double pole switch with contact gap of at least 3 mm.

Please pay attention to separate routing of sensor cables and mains cables.

In order to mount the device to the wall, carry out the following steps:

1. Unscrew the crosshead screw from the cover and remove it along with the cover from the housing.
2. Mark the upper fastening point on the wall. Drill and fasten the enclosed wall plug and screw leaving the head protruding.
3. Hang the housing from the upper fastening point and mark the lower fastening points (centres 130 mm).
4. Insert lower wall plugs.
5. Fasten the housing to the wall with the lower fastening screw and tighten.
6. Carry out the electrical wiring in accordance with the terminal allocation, (see page 8).
7. Put the cover on the housing.
8. Attach with the fastening screw.

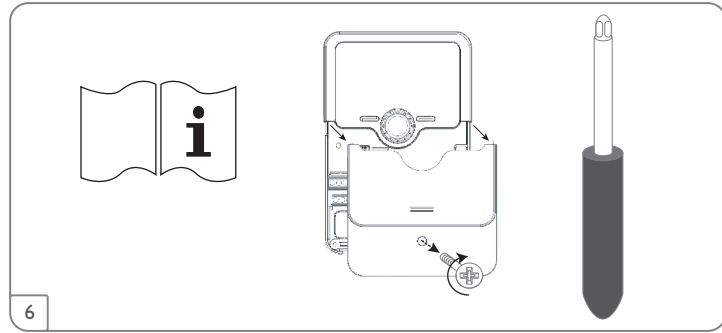
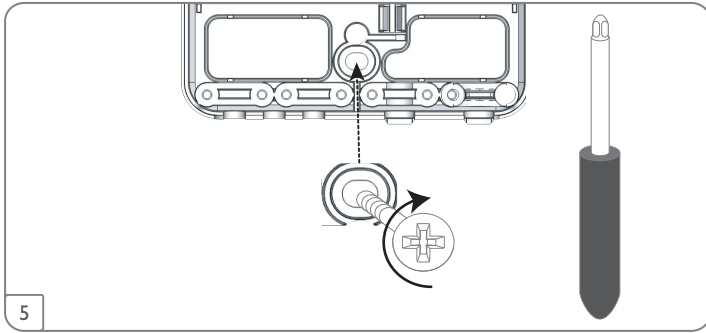
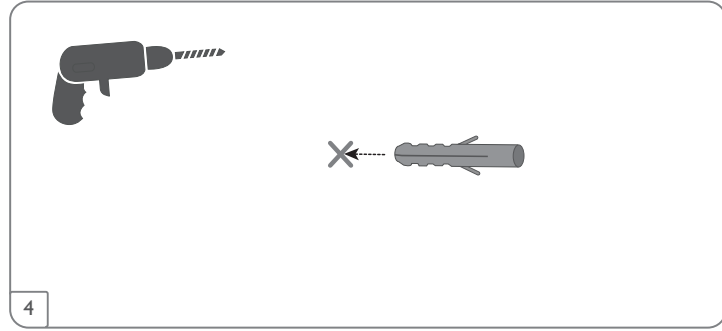
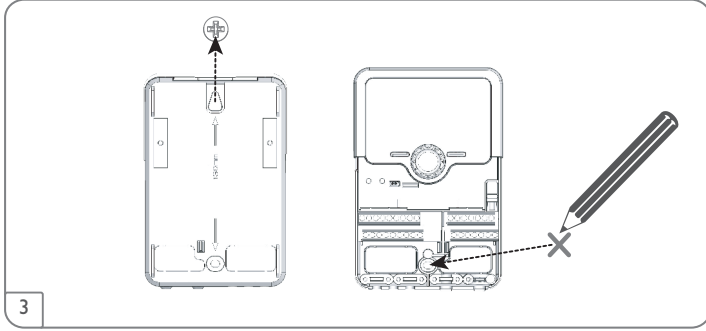
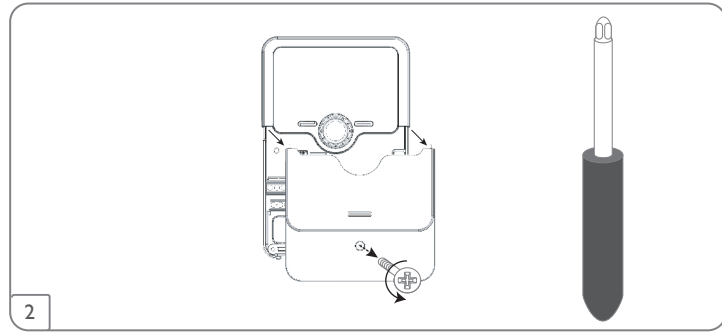
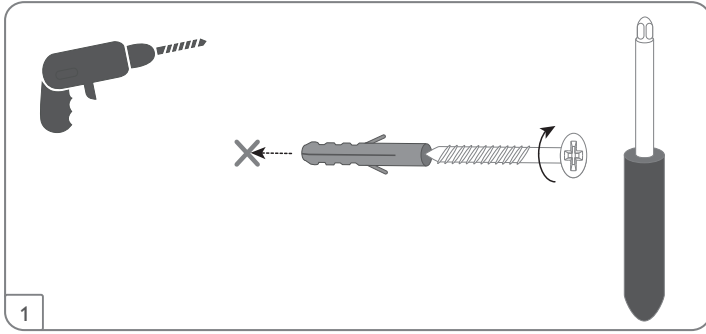

## 2.2 Electrical connection

### WARNING! Electric shock!



Upon opening the housing, live parts are exposed!

→ **Always disconnect the controller from power supply before opening the housing!**

### ATTENTION! ESD damage!



Electrostatic discharge can lead to damage to electronic components!

→ **Take care to discharge properly before touching the inside of the device! To do so, touch a grounded surface such as a radiator or tap!**



#### Note:

Connecting the device to the power supply must always be the last step of the installation!



#### Note:

The pump speed must be set to 100% when auxiliary relays or valves are connected.



#### Note

It must be possible to disconnect the device from the mains at any time.

→ Install the mains plug so that it is accessible at any time.

→ If this is not possible, install a switch that can be accessed.

If the mains cable is damaged, it must be replaced by a special connection cable which is available from the manufacturer or its customer service.

### Do not use the device if it is visibly damaged!

The controller is supplied with power via a mains cable. The power supply of the device must be 100... 240 V~ (50... 60 Hz).

The controller is equipped with 4 relays in total to which loads such as pumps, valves, etc. can be connected:

- Relays 1... 3 are semiconductor relays, designed for pump speed control:
- Conductor R1... R3
- Neutral conductor N
- Protective conductor (⊖)
- Relay 4 is a potential-free low voltage relay

Depending on the product version, mains cables and sensor cables are already connected to the device. If that is not the case, please proceed as follows:

Attach flexible cables to the housing with the enclosed strain relief and the corresponding screws.

**Temperature sensors** have to be connected to the terminals S1... S4 and GND (either polarity).

The cables carry low voltage and must not run together in a cable conduit with cables carrying a voltage higher than 50 V (please pay attention to the valid local regulations). The cable lengths depend on the cross sectional area.

Example: up to 100 m at 1.5 mm<sup>2</sup>, up to 50 m at 0.75 mm<sup>2</sup>. The cables can be extended with a two-wire cable.

Connect the **Grundfos Direct Sensor™** to the S6 input.

Connect the flow rate sensor with frequency signal to the S7 input.

A **V40** flowmeter can be connected to the terminals S5/V40 and GND (either polarity). The terminals marked **PWM** are control outputs for a high-efficiency pump (convertible to 0-10 V signal outputs, see page 62).

### Electrical connection of a high-efficiency pump (HE pump)

Speed control of a HE pump is possible via a PWM signal / 0-10V control. The pump has to be connected to the relay (power supply) as well as to one of the PWM outputs of the controller. In the **Outputs** adjustment channel one of the PWM control types as well as a relay have to be selected (see page 62).

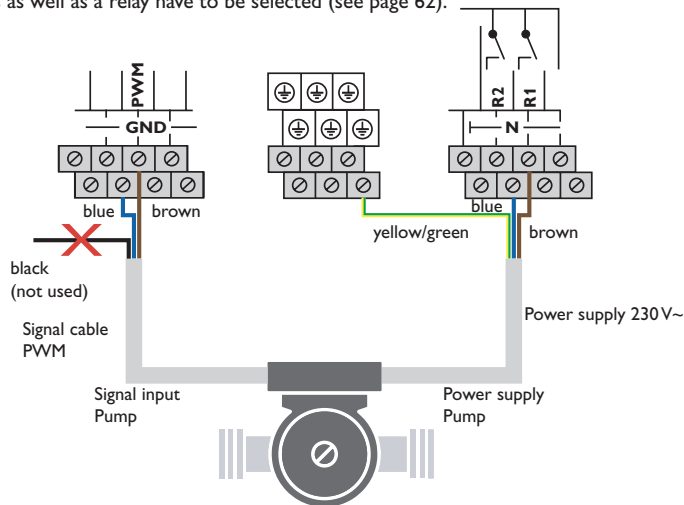



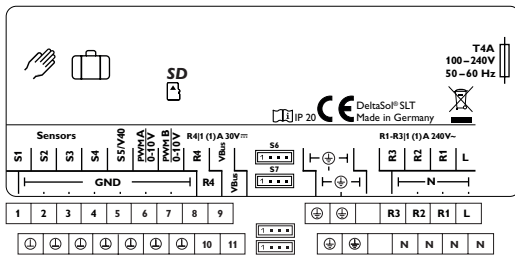

The **mains connection** is at the terminals:

Neutral conductor N

Conductor L

Protective conductor  $\oplus$

**Note:**  
For further information about heat quantity measurement with a Grundfos Direct Sensor™ see page 57.

**Note:**  
The connection depends on the system layout selected (see page 20).

**Note:**  
For more details about the initial commissioning procedure see page 10.

### 2.3 Data communication/Bus

The controller is equipped with the **VBus®** for data transfer and energy supply to external modules. The connection is carried out at the 2 terminals marked **VBus** (any polarity).

One or more **VBus®** modules can be connected via this data bus, such as:

- DL2/DL3 Datalogger
- VBus®/USB or VBus®/LAN interface adapters

Different solutions for visualisation and remote parameterisation are available on the website [www.resol.com](http://www.resol.com). On the website, firmware updates are also available.

**Note:**  
More accessories in page 67.

### 2.4 MicroSD card slot

The controller is equipped with a MicroSD card slot.

With a MicroSD card, the following functions can be carried out:

- Store measurement and balance values onto the MicroSD card. After the transfer to a computer, the values can be opened and visualised, e.g. in a spreadsheet.
- Prepare adjustments and parameterisations on a computer and transfer them via the MicroSD card.
- Store adjustments and parameterisations on the MicroSD card and, if necessary, retrieve them from there.
- Download firmware updates from the Internet and install them on the controller via MicroSD card.

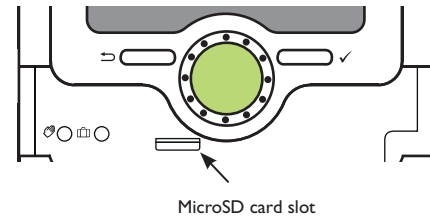

A MicroSD card is not included, but can be purchased from the manufacturer.

**Note:**  
For more information about using a MicroSD card, see page 59.

### 3 Step-by-step parameterisation

The *DeltaSol*® SLT is a controller that offers a broad variety of functions to the user. At the same time, the user has a lot of freedom in configuring them. Therefore, to set up a complex system, careful planning is required. We recommend drawing a sketch of the system first.

If planning, hydraulic construction and electrical connection have all been carried out successfully, proceed as follows:

#### 1. Running the commissioning menu

The commissioning menu is run after the first connection and after every reset. It will request the following basic adjustments:

- Menu language
- Temperature unit
- Volume unit
- Pressure unit
- Energy unit
- Auto DST
- Time
- Date
- Selection: System or Scheme
- Scheme number (if selection = Scheme)
- Solar system (if selection = System)
- Hydraulic variant (if selection = System)

At the end of the commissioning menu, a security enquiry follows. If the security enquiry is confirmed, the adjustments are saved.

For further information about the commissioning menu see page 17.

#### 2. Registering sensors

If a flowmeter, a flow switch, a flow rate sensor and / or a Grundfos Direct Sensor™ are connected, these have to be registered in the Inputs/Outputs menu.

For detailed information about the registration of sensors see page 61.

#### 3. Activating solar optional functions

The basic solar system has been adjusted during commissioning. Now, optional functions can be selected, activated and adjusted.

Free relays can be allocated to optional functions which require a relay. The controller always suggests the numerically smallest free relay.

Sensors can be allocated to more than one function.

For further information about the solar optional functions see page 30.

#### 4. Activating optional arrangement functions

Now, optional functions for the non-solar part of the arrangement can be selected, activated and adjusted.

Free relays can be allocated to optional functions which require a relay. The controller always suggests the numerically smallest free relay.

Sensors can be allocated to more than one function.

For further information about the optional arrangement functions see page 44.

#### 5. Activating heating optional functions

For the heating part of the arrangement, optional functions can be selected, activated and adjusted.

To optional functions which require one or more relays, the corresponding number of free relays can be allocated. The controller always suggests the numerically smallest free relay.

Sensors can be allocated to more than one function.

For more information about heating optional functions, see page 53.

## 4 Operation and function

### 4.1 Buttons and adjustment dial

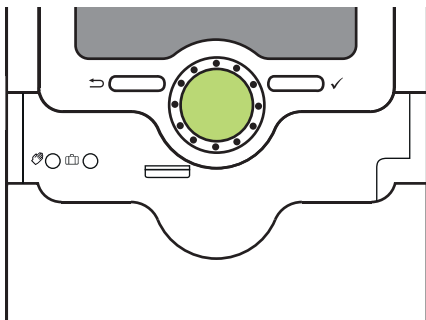

The controller is operated via 2 buttons and 1 adjustment dial (Lightwheel®) below the display:

Left button (←) - escape button for changing into the previous menu

Right button (✓) - confirming/selecting

Lightwheel® - scrolling upwards/scrolling downwards, increasing adjustment values/reducing adjustment values

### 4.2 Microbutton for manual mode and holiday mode



The controller is equipped with 2 microbuttons for quick access to the manual mode and the holiday function. The microbuttons are located underneath the slideable housing cover, the Slider.

Microbutton (☞): If the microbutton (☞) is briefly pressed, the controller changes to the manual mode menu (see page 60).

Microbutton (☞): The microbutton (☞) is used for activating the holiday function (see page 43). If the microbutton is pressed and held down for approx. 3 s, the adjustment channel **Days of absence** appears, allowing to enter the number of days for an absence. If the parameter is set to a value higher than 0, the function becomes active using the adjustments that have previously been made in the **Holiday** menu. The days will be counted backwards at 00:00. If the value is set to 0, the function is deactivated.

### 4.3 Control lamp

The controller is equipped with a multicolour LED in the centre of the Lightwheel®, indicating the following states:

Colour	Permanently shown	Flashing
	Everything OK	Manual mode: at least one relay in manual operation
		Sensor line break, sensor short circuit, flow rate monitoring, overpressure, low pressure
	Holiday function active	ΔT too high, night circulation, FL/RE interchanged, store maximum temperature exceeded, update in progress, MicroSD card writing error

### 4.4 Selecting menu points and adjusting values

During normal operation of the controller, the display is in the status menu. If no button is pressed for 1 min, the display illumination goes out. After 3 more minutes, the controller switches to the Status menu.

→ In order to get from the Status menu into the Main menu, press the left button (←)!

→ Press any key to reactivate the display illumination.

→ In order to scroll through the display channels, turn the Lightwheel®.

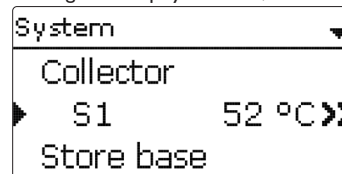

If the symbol ► is shown behind a menu item, pressing the right button (✓) will open a new sub-menu.

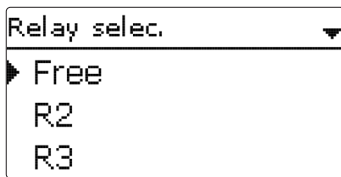

Values and adjustments can be changed in different ways:

Numeric values can be adjusted by means of a slide bar. The minimum value is indicated to the left, the maximum value to the right. The large number above the slide bar indicates the current adjustment. By turning the Lightwheel®, the upper slide bar can be moved to the left or to the right.

Only after the adjustment has been confirmed by pressing the right button (✓) will the number below the slide bar indicate the new value. The new value will be saved if it is confirmed by pressing the right button (✓) again.

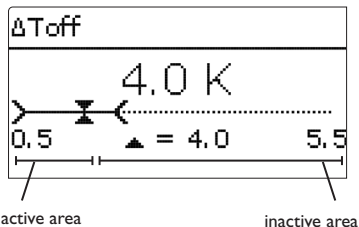

When 2 values are locked against each other, they will display a reduced adjustment range depending on the adjustment of the respective other value.

In this case, the active area of the slide bar is shortened, the inactive area is indicated as a dotted line. The indication of the minimum and maximum values will adapt to the reduction.

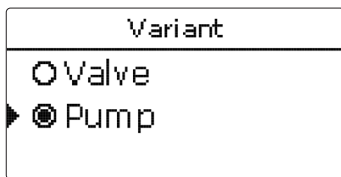

If only one item of several can be selected, they will be indicated with radio buttons. When one item has been selected, the radio button in front of it is filled.

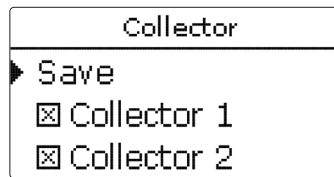

If more than one item of several can be selected, they will be indicated with checkboxes. When an item has been selected, an x appears inside the checkbox.

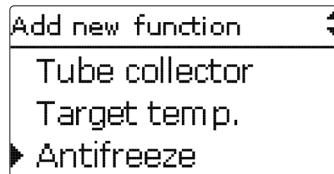

If further menu items are available and the symbol  $\blacktriangleleft\blacktriangleright$  is indicated on the upper right-hand side of the display, more menu items can be accessed by turning the Lightwheel®.

## Adjusting the timer

When the **Timer** option is activated, a timer is indicated in which time frames for the function can be adjusted.

In the **Day selection** channel, the days of the week are available individually and as frequently selected combinations.

If more than one day or combination is selected, they will be merged into one combination for the following steps.

The last menu item after the list of days is **Continue**. If **Continue** is selected, the timer menu opens, in which the time frames can be adjusted.

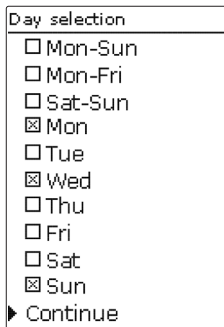
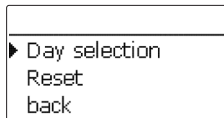

## Adding a time frame:

In order to add a time frame, proceed as follows:

### 1. Select New time frame

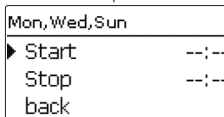
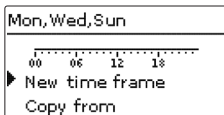

### 2. Adjust Start and Stop for the desired time frame.

The time frames can be adjusted in steps of 5 min.

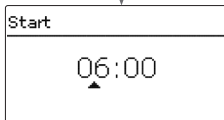

### 3. In order to save the time frame, select **Save** and confirm the security enquiry with **Yes**.

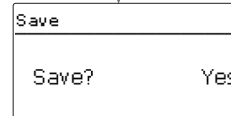
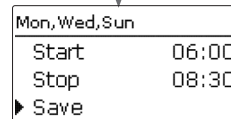
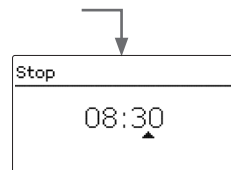

### 4. In order to add another time frame, repeat the previous steps.

6 time frames can be adjusted per day or combination.

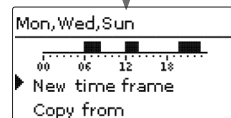
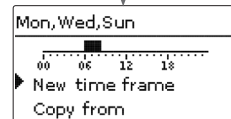

### 5. Press the left button (←) in order to get back to the day selection.

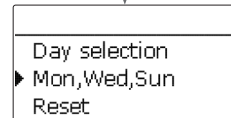

### Copying a time frame:

In order to copy time frames already adjusted into another day/another combination, proceed as follows:

1. Choose the day/The combination into which the time frames are to be copied and select **Copy from**.

A selection of days and/or combinations with time frames will appear.

2. Select the day or combination from which the time frames are to be copied.

All time frames adjusted for the selected day or combination will be copied.

If the time frames copied are not changed, the day or combination will be added to the combination from which the time frames have been copied.

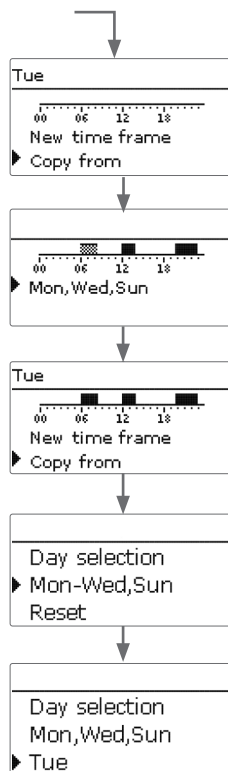

### Changing time frames:

In order to change a time frame, proceed as follows:

1. Select the desired time frame.
2. Make the desired change.
3. In order to save the time frame, select **Save** and confirm the security enquiry with **Yes**.

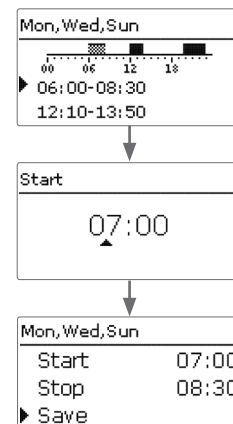

### Removing a time frame:

In order to delete a time frame, proceed as follows:

1. Select the time frame that is to be deleted.
2. Select **Delete** and confirm the security enquiry with **Yes**.

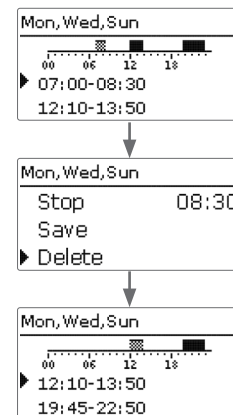

### Resetting the timer:

In order to reset time frames adjusted for a certain day or combination, proceed as follows:

1. Select the desired day or combination.
2. **Select Reset and confirm the security enquiry with Yes.**

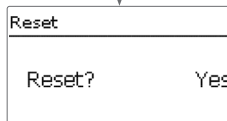
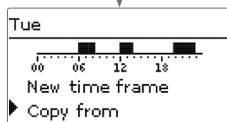
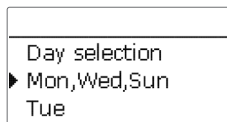

The selected day or combination will disappear from the list, all its time frames will be deleted.

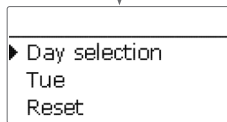

In order to reset the whole timer, proceed as follows:

- ➔ Select **Reset** and confirm the security enquiry with **Yes**.

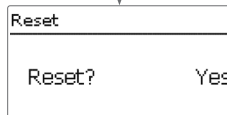
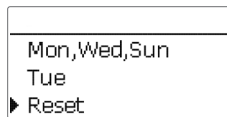

All adjustments made for the timer are deleted.

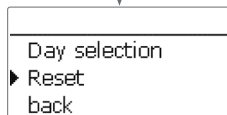

## 4.5 Menu structure

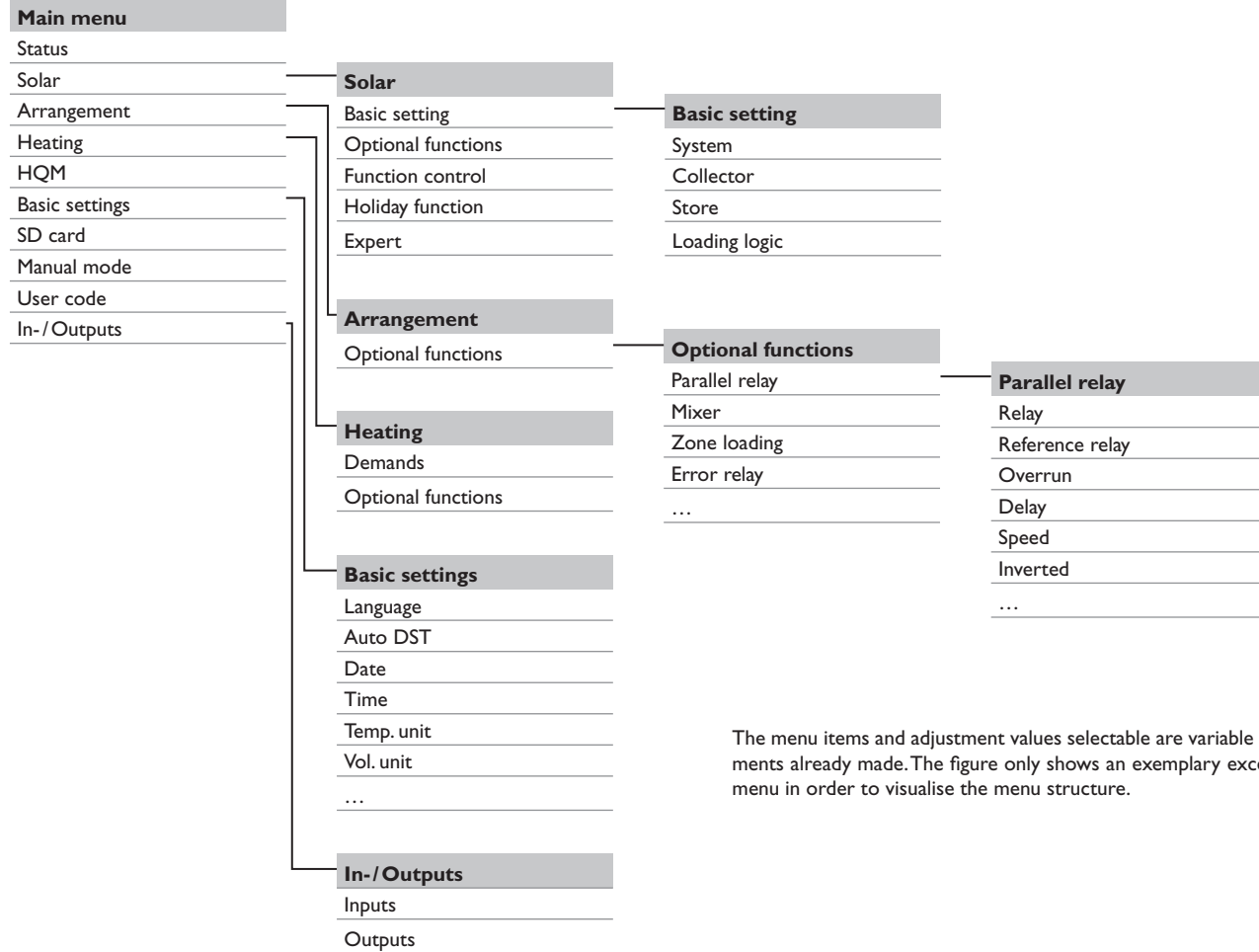

The menu items and adjustment values selectable are variable depending on adjustments already made. The figure only shows an exemplary excerpt of the complete menu in order to visualise the menu structure.



## 5 Commissioning

When the hydraulic system is filled and ready for operation, connect the controller to the mains.

The controller runs an initialisation phase in which the Lightwheel® flashes red.

When the controller is commissioned or when it is reset, it will run a commissioning menu after the initialisation phase. The commissioning menu leads the user through the most important adjustment channels needed for operating the system.

### Commissioning menu

The commissioning menu consists of the channels described in the following. In order to make an adjustment, adjust the value by turning the Lightwheel® and confirm by pressing the right button (✓). The next channel will appear in the display.

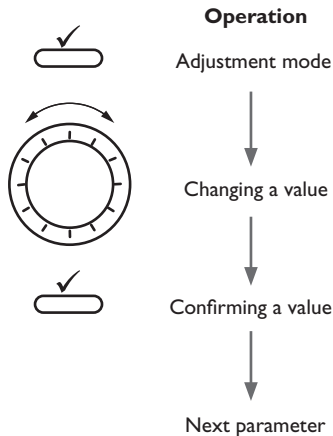

### 1. Language:

→ Adjust the desired menu language.

### 2. Units:

1. Adjust the desired temperature unit.

2. Adjust the desired volume unit.

3. Adjust the desired pressure unit.

4. Adjust the desired energy unit.

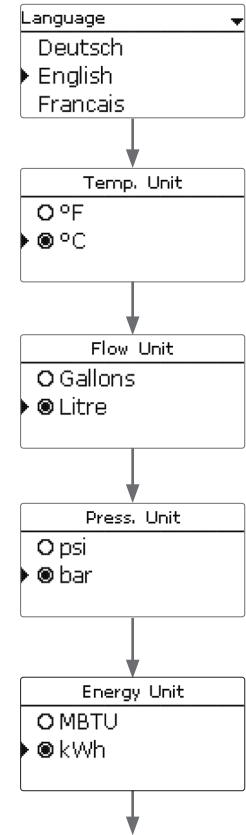

**3. Daylight savings time adjustment:**

- Activate or deactivate the automatic daylight savings time adjustment.

**4. Time:**

- Adjust the clock time. First of all adjust the hours, then the minutes.

**5. Date:**

- Adjust the date. First of all adjust the year, then the month and then the day.

**6. Selection: System or Scheme**

- Choose whether the controller is to be configured with a scheme number or with a system and a variant.

**7a. Scheme (if 6. = Scheme)**

- Enter the scheme number of the desired system.

**7b. Selection of the solar system (if 6. = System):**

- Adjust the desired solar system (number of collectors and stores, hydraulic variants).

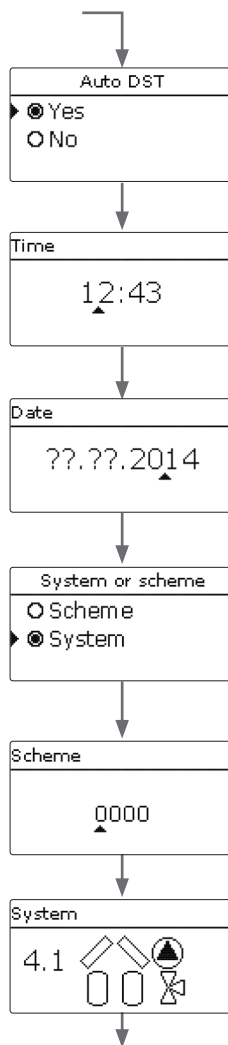
**8. Completing the commissioning menu:**

After the system has been selected or the scheme number has been entered respectively, a security enquiry appears. If the security enquiry is confirmed, the adjustments are saved.

- In order to confirm the security enquiry, press the right button (✓).
- In order to reenter the commissioning menu channels, press the left button (↶).

If the security enquiry has been confirmed, the controller is ready for operation and normally the factory settings will give close to optimum operation.

**Note:**

The adjustments carried out during commissioning can be changed anytime in the corresponding adjustment channel. Additional functions and options can also be activated or deactivated.

**Set the code to the customer code before handing over the controller to the customer (see page 60).**

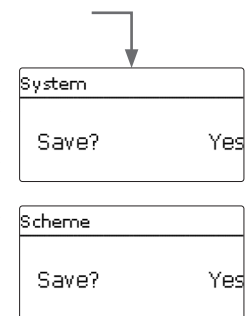

## 5.1 Basic systems and hydraulic variants

### System

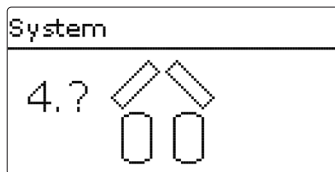

The controller is pre-programmed for 4 basic systems. The selection depends on the number of heat sources (collector fields) and heat sinks (stores, pool). Factory setting is system 1.

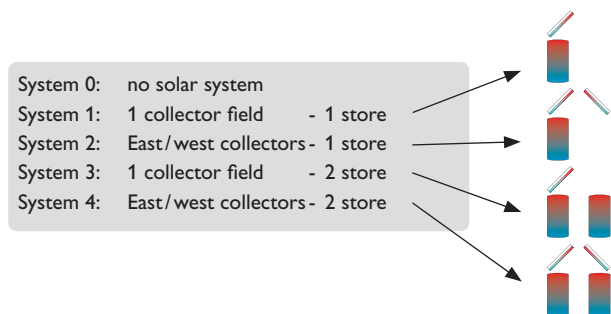

**A solar system with store loading in layers is implemented as a 2-store system (store top = store 1; store bottom = store 2).**

The selection of the basic solar system is one of the most important adjustments and is thus requested already in the commissioning menu.

First, the basic system is adjusted by means of the number of stores and collector fields, then the hydraulic variant.

The selected system is visualised by the corresponding number of store and collector symbols. The figure to the left shows system 4 which consists of 2 stores and 2 collector fields ("east- / west collectors").

### Variant

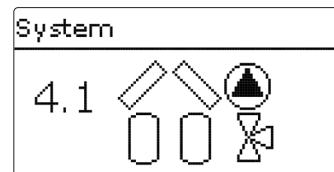

The hydraulic variant refers to the different actuators that are to be controlled. They are visualised on the display by means of symbols, when the variant is selected. The upper symbol indicates the actuator belonging to the collector fields, the lower one the actuators belonging to the stores.

The exemplary figure shows the display indicated when system 4, variant 1 has been selected. In this case, each collector field has a pump, the stores are loaded by means of valve logic.

For each variant, the controller allocates the corresponding relays and sensors. The allocations of the most important combinations are shown in chap. 5.2.

## 5.2 Overview of relay and sensor allocation

### System 1

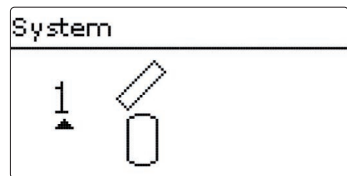

#### Sensors

Collector 1	S1
Store base	S2

#### Relay; PWM/0-10V

Solar pump	R1; A
------------	-------

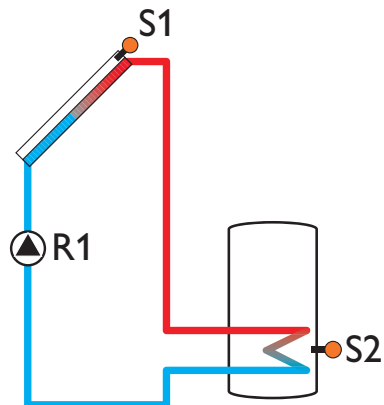

### System 2 variant 1

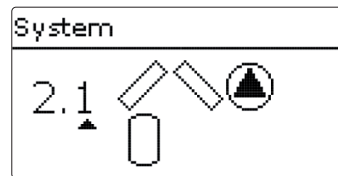

#### Sensors

Collector 1	S1
Store base	S2
Collector 2	S3

#### Relay; PWM/0-10V

Pump collector 1	R1; A
Pump collector 2	R2; B

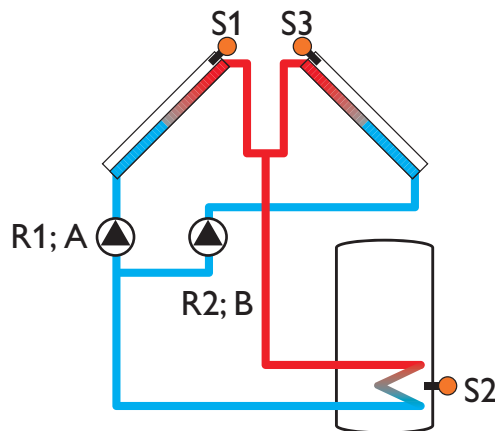

## System 2 variant 2

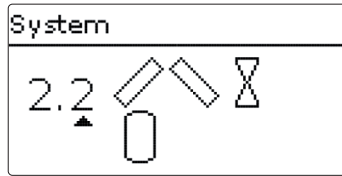

Sensors		Relay; PWM/0-10 V	
Collector 1	S1	2-PV collector 1	R1
Store base	S2	2-PV collector 2	R2
Collector 2	S3	Solar pump	R3;A

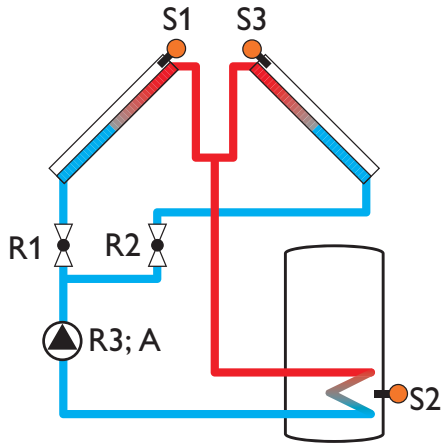

## System 3 variant 1

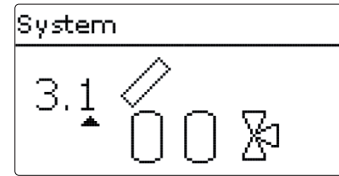

Sensors		Relay; PWM/0-10 V	
Collector	S1	Solar pump	R1; A
Store 1 base	S2	3-PV store 2	R2
Store 2 base	S4		

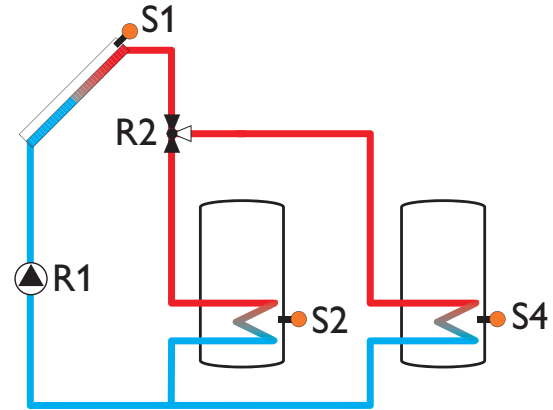

## System 3 variant 2

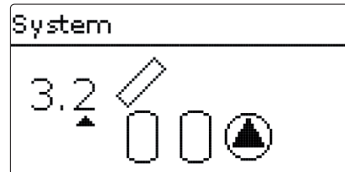

### Sensors

Collector	S1	Solar pump store 1	R1; A
Store 1 base	S2	Solar pump store 2	R2; B
Store 2 base	S4		

### Relay; PWM/0-10V

Solar pump store 1	R1; A
Solar pump store 2	R2; B

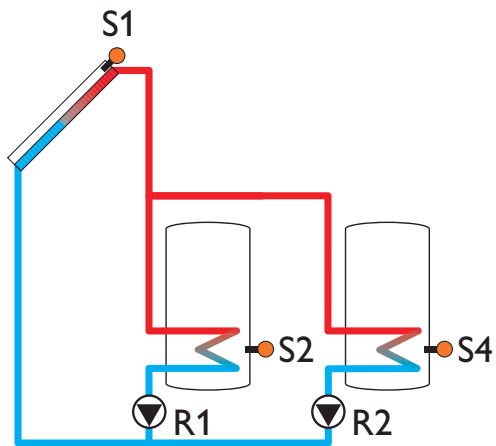

## System 3 variant 3

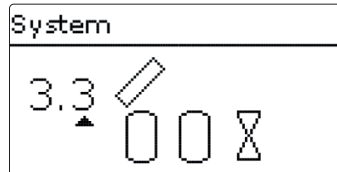

### Sensors

Collector	S1	Solar pump	R1; A
Store 1 base	S2	2-PV store 1	R2
Store 2 base	S4	2-PV store 2	R3

### Relay; PWM/0-10V

Solar pump	R1; A
2-PV store 1	R2
2-PV store 2	R3

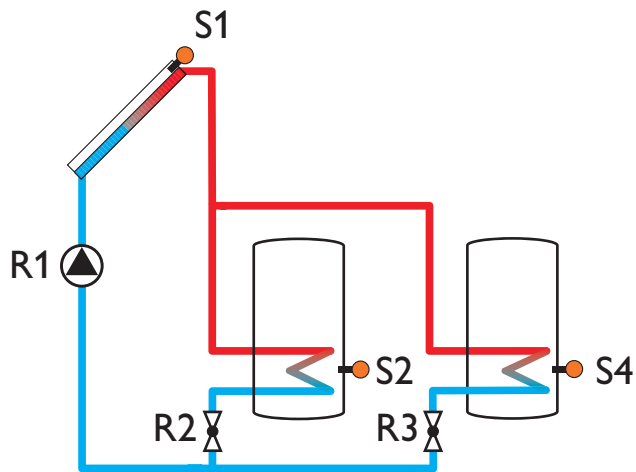

## System 4 variant 1

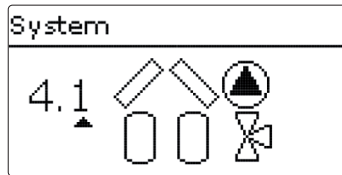

### Sensors

Collector 1	S1
Store 1 base	S2
Collector 2	S3
Store 2 base	S4

### Relay; PWM/0-10V

Pump collector 1	R1; A
Pump collector 2	R2; B
3-PV store 2	R3

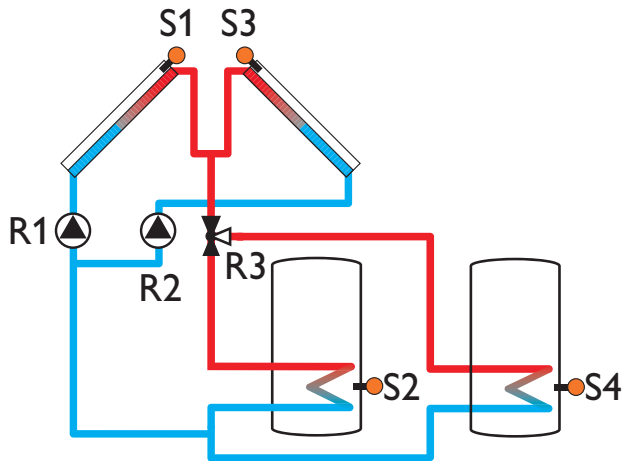

## 6 Main menu

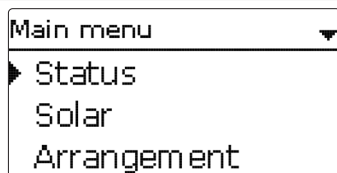

In this menu, the different menu areas can be selected.

The following menus are available:

- Status
- Solar
- Arrangement
- Heating
- HQM
- Basic settings
- SD card
- Manual mode
- User code
- In-/Outputs

1. Select the menu area by turning the Lightwheel®.
2. Press the right button (✓) in order to enter the selected menu area.

If no button is pressed for 1 min, the display illumination goes out. After 3 more minutes, the controller switches to the Status menu.

- ➔ In order to get from the Status menu into the Main menu, press the left button (↶)!

## 7 Status

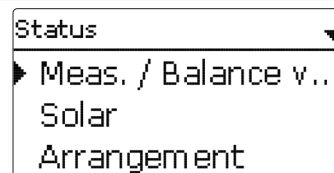

In the **Status** menu of the controller, the status messages for every menu area can be found.

### 7.1 Meas./Balance values

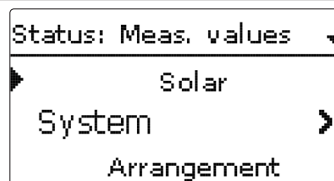

In the **Status/Meas./Balance values** menu, all current measurement values as well as a range of balance values are displayed. Some of the menu items can be selected in order to enter a sub-menu.

Additionally, all optional functions selected, the operating hours counter as well as activated heat quantity measurements are displayed.

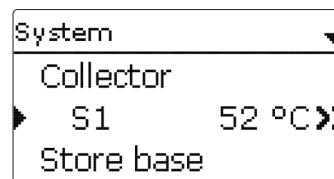

If, for example, **Solar/System** is selected, a sub-menu with the sensors and relays allocated to the solar system opens. In the sub-menu, the current temperatures and the current pump speed are displayed.

When a line with a measurement value is selected, another sub-menu will open.



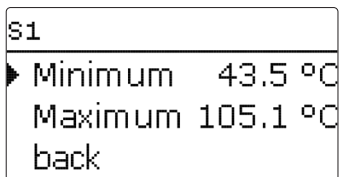

If, for example, **S1** is selected, a sub-menu indicating the minimum and maximum values will open.

## 7.2 Solar

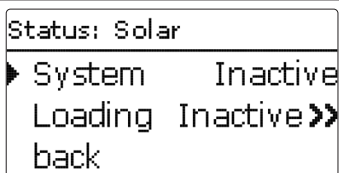

In the **Status/Solar** menu, the status of the solar system, the solar loading and the selected optional functions are indicated.

## 7.3 Arrangement

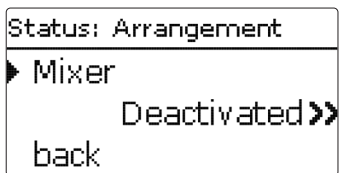

In the **Status/Arrangement** menu, the status of the selected optional functions is indicated.

## 7.4 Heating

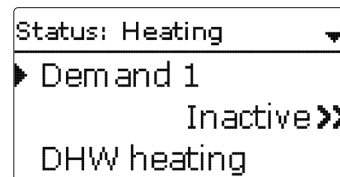

In the **Status/Heating** menu, the status of the demands activated as well as of the selected optional functions is indicated.

## 7.5 Messages

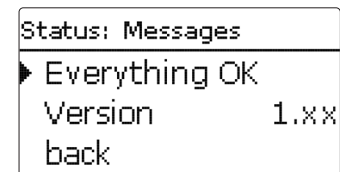

In the **Status/Messages** menu, error and warning messages which have not been acknowledged are indicated.

During normal operation, the message **Everything OK** is indicated.

When a monitoring function from the function control is activated and detects a fault condition, a corresponding message is indicated (see table).

A message consists of the name of the monitoring function, a 4-digit error code and a short text description of the fault condition.

In order to acknowledge the message, proceed as follows:

1. Select the code of the desired message by turning the Lightwheel®.
2. Confirm your selection with the right button (✓).
3. Confirm the security enquiry by selecting **Yes**.

When the installer user code has been entered, the menu item **Restarts** will appear below the messages. The value indicates the number of controller restarts since commissioning. This value cannot be reset.

## Messages

Error code	Display	Monitoring function	Cause
0001	!Sensor fault	Sensor line break	Sensor line broken
0002	!Sensor fault	Sensor short circuit	Sensor line short-circuited
0011	!ΔT too high	ΔT too high	Collector 50 K > than store to be loaded
0021	!Night circulation	Night circulation	Betw. 11 p.m. and 5 a.m. col. temp > 40 °C
0031	!FL/RL interch.	FL/RL interchanged	Col. temp. does not rise after switching on
0041	!Flow rate monit.	Flow rate monitoring	No flow rate at sensor
0051	!Overpressure	Overpressure monitoring	Max. system pressure exceeded
0052	!Low pressure	Low pressure monitoring	System pressure below minimum
0061	!Data storage def.	Storing and changing adjustments not possible	
0071	!RTC module def.	Time-controlled functions (e. g. night correction) not possible	
0081	!Store max. temp.	Maximum store temperature	St. max has been exceeded
0091	Restarts	Restart counter (non-adjustable)	Number of restarts since commissioning



### Note:

The function control “flow and return interchanged” according to the VDI guidelines 2169 can only correctly detect and indicate the error “0031 !FL/RE INTERCHANGED!” if the collector sensor measures the temperature directly in the fluid at the collector outlet. If the collector sensor is not correctly placed, a false message may occur.

- ➔ Place the collector sensor directly in the fluid at the collector outlet or deactivate the “flow and return interchanged” function control.

Service	
▶	S1
	Collector 1
	S2

In the **Status/Service** menu, each sensor and relay is indicated with the component or function it has been allocated to. For free sensors and relays, **Free** is indicated.

Solar	
▶	Basic settings
	Opt. functions
	Function control

In this menu, all adjustments for the solar part of the arrangement can be made. The **Solar** menu consists of the following sub-menus:

- Basic setting
- Optional functions
- Function control
- Holiday function
- Expert

### 8.1 Basic solar settings

In this menu, all basic settings for the solar part of the arrangement can be adjusted. In this menu, the hydraulic system, which is the basis for the arrangement, can be adjusted. The setting is divided into systems and variants.

Both system and variant have usually been adjusted during commissioning. If the setting is changed later on, all adjustments for the solar part of the arrangement are set back to their factory settings.

If the change causes the solar system to require a relay that has been allocated to an arrangement or heating function before, all adjustments made in the non-solar function will be set back to their factory settings as well.

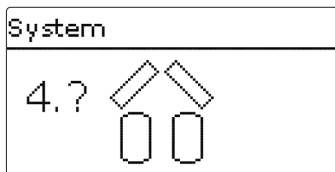

First of all, the basic solar system can be selected according to the number of stores and collector fields in use. The corresponding numbers are indicated on the display. The exemplary figure shows system 4 with its 2 stores and 2 collector fields (east-/west collectors).

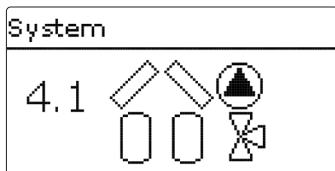

When the basic system has been selected and confirmed, the hydraulic variant can be selected. The variant is visualised on the display by means of pump and valve symbols. The exemplary figure shows variant 1 of system 4 with a 3-port valve and a pump. For an overview of the basic systems and their variants see page 17.

The controller supports up to 2 collector fields and up to 2 solar stores.

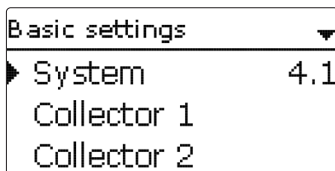

The following items in the **Solar/Basic settings** menu will adjust to the system selected.

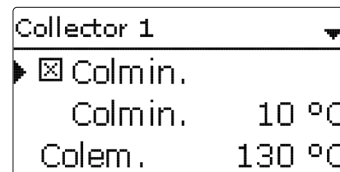

### Collector (1, 2)

In systems with 2 collector fields, 2 separate menu items (**Collector 1** and **Collector 2**) are displayed instead of **Collector**.

For each collector field, a collector minimum limitation and a collector emergency shutdown temperature can be adjusted.

### Solar/Basic settings/Collector (1, 2)

Adjustment channel	Description	Adjustment range/selection	Factory setting
Colmin.	Minimum collector limitation	Yes, No	Yes
Colmin.	Minimum collector temperature	10 ... 90 °C	10 °C
Colem.	Collector emergency temperature	80 ... 200 °C	130 °C

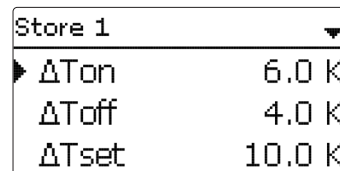

### Store (1, 2)

In systems with 2 or more stores, 2 separate menu items (**Store 1** and **Store 2**) are displayed instead of **Store**.

For each store, an individual  $\Delta T$  control, a set and a maximum temperature, the priority (in multi-store systems), a hysteresis, a rise value, a minimum runtime and a minimum pump speed can be adjusted.

In multi-store-systems with differing Store set/Maximum store temperatures, all stores are loaded up to their set temperatures first, then up to their maximum store temperatures (according to their priority and the store sequence control).

If one of the stores does not reach its set temperature, e. g. because the temperature difference is not sufficiently high, the subsequent store will be loaded past its set temperature up to its maximum temperature, if the switch-on condition is fulfilled.

## Solar/Basic settings/Store (1, 2)

Adjustment channel	Description	Adjustment range/selection	Factory setting
$\Delta T_{on}$	Switch-on temperature difference	1.0 ... 20.0 K	6.0 K
$\Delta T_{off}$	Switch-off temperature difference	0.5 ... 19.5 K	4.0 K
$\Delta T_{set}$	Set temperature difference	1.5 ... 30.0 K	10.0 K
Stset	Store set temperature	4 ... 95 °C	45 °C
Stmax	Maximum store temperature	4 ... 95 °C	60 °C
Priority	Store priority	1,2	system dependent
HysSt	Hysteresis maximum store temperature	0.1 ... 10.0 K	2.0 K
Rise	Rise value	1.0 ... 20.0 K	2.0 K
tMin	Minimum runtime	0 ... 300 s	30 s
Min. speed	Minimum speed	(20) 30 ... 100%	30%
Deactivated	Blocked for solar loading	Yes, No	No

The store number refers to the corresponding store sensor, not to the priority of the store. In the **Priority** channel, the corresponding store number is suggested as factory setting, but may be changed at will.

The store numbers refer to the sensors as follows:

Store 1 = Sensor S2

Store 2 = Sensor S4

If the temperature reaches or exceeds the switch-on temperature difference, the pump switches on at 100% speed for 10 s. Then, the speed is reduced to the minimum pump speed value. If the temperature difference exceeds the adjusted nominal value by 1/10 of the Rise value, the pump speed increases by one step (1 %). The response of the controller can be adapted via the parameter Rise. Each time the difference increases by 1/10 of the adjustable rise value, the pump speed increases by one step until the maximum pump speed of 100% is reached. If the temperature difference decreases by 1/10 of the adjustable rise value, pump speed will be decreased by one step.

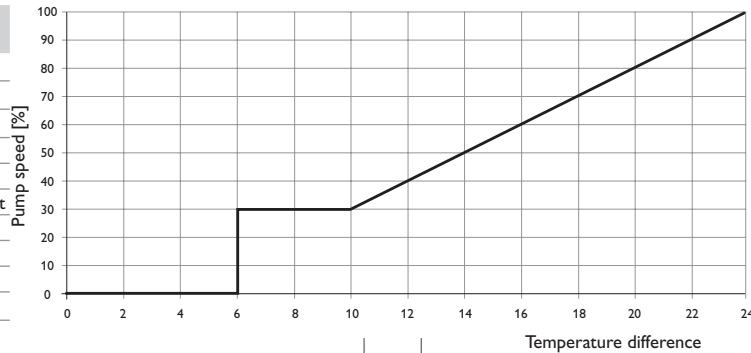

Detail

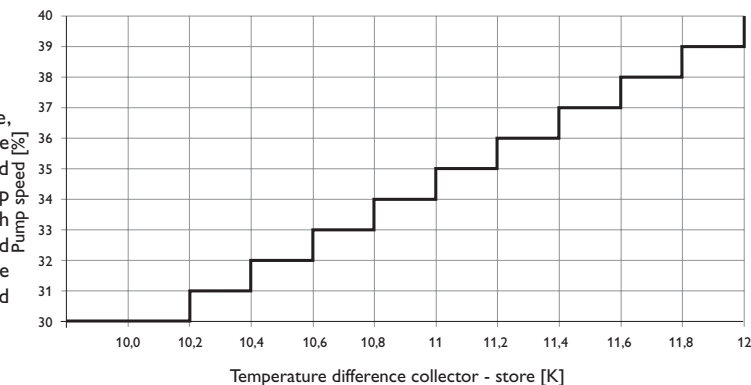

## Loading logic

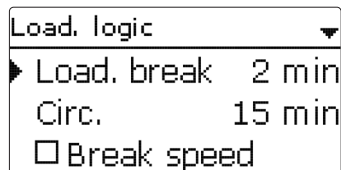

## Solar/Basic settings/Loading logic

Adjustment channel	Description	Adjustment range/selection	Factory setting
Load. break	Loading break time	1 ... 5 min	2 min
Circ.	Circulation time	1 ... 60 min	15 min
Pause speed	Loading break pump speed control option	Yes, No	No
Speed	Loading break pump speed	(20) 30 ... 100 %	30 %
Pump del.	Pump delay	Yes, No	No
Delay	Delay time	5 ... 600 s	15 s

In systems with 2 stores, loading logic adjustments can be made in this menu.

### Store sequence control:

If the priority store cannot be loaded, the subordinate store will be checked. If useful heat can be added, it will be loaded for the circulation time. After this, the loading process stops and the controller monitors the increase in collector temperature during the loading break time **Load. break**. If it increases by 2K, the break time timer starts again to allow the collector to gain more heat. If the collector temperature does not increase sufficiently, the subordinate store will be loaded again for the circulation time.

As soon as the switch-on condition of the priority store is fulfilled, it will be loaded. If the switch-on condition of the priority store is not fulfilled, loading of the second store will be continued. If the priority store reaches its maximum temperature, store sequence control will not be carried out.

Each loading process will be carried out for the duration of the minimum runtime (**tMin** in the Solar/Basic settings/Store menu) at least, regardless of the switch-off condition.



### Note:

In systems 1 and 2, only the menu item **Pump delay** will be available.

## 8.2 Solar optional functions

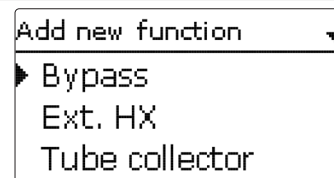

In this menu, optional functions can be selected and adjusted for the solar part of the arrangement.

By selecting **Add new function**, different pre-programmed functions can be selected. The kind and number of optional functions offered depends on the previous adjustments.

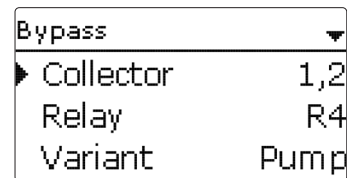

When a function is selected, a sub-menu opens in which all adjustments required can be made.

With this menu item, a relay and, if necessary, certain system components can be allocated to the function.

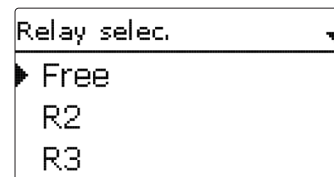

The menu item **Relay** is available in almost all optional functions. Therefore, it will not be explained in the individual function descriptions.

With this menu item, a relay can be allocated to the function. All free relays are available for selection.

If **Free** is selected, the function will run normally in the software but will not operate a relay.

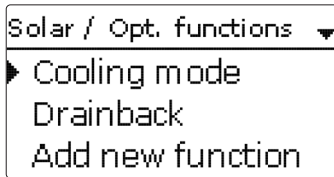

When a function has been adjusted and saved, it will appear in the **Opt. functions** menu above the menu item **Add new function**.

This allows an easy overview of functions already saved.

An overview about which sensor has been allocated to which component and which relay has been allocated to which function is given in the **Status/Service** menu.

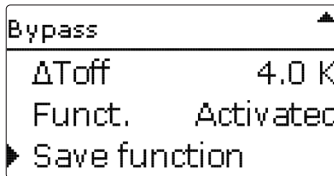

At the end of each optional function sub-menu, the menu items **Function** and **Save function** are available. In order to save a function, select **Save function** and confirm the security enquiry by selecting **Yes**.

In functions already saved, the menu item **Delete function** appears instead.

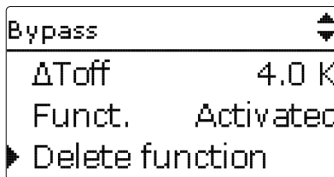

In order to delete a function already saved, select **Delete function** and confirm the security enquiry by selecting **Yes**.

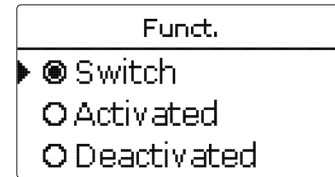

With the menu item **Function**, an optional function already saved can be temporarily deactivated or re-activated respectively. In this case, all adjustments will remain stored, the allocated relays remain occupied and cannot be allocated to another function.

By selecting **Switch**, the function can be activated or deactivated respectively by means of an external switch.

The selection is only available if a sensor input has previously been set to Switch in the **Inputs/Outputs** menu.

If Switch is selected, the channel Sensor will appear. In this channel, the sensor input to which the switch is to be connected can be allocated to the function.

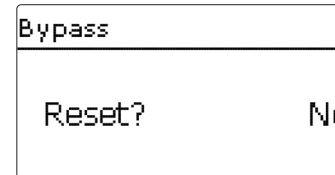
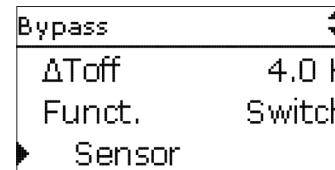

If the menu item **Delete function** is confirmed by pressing the right button (✓), a security enquiry appears. The setting can be changed between **Yes** and **No** by turning the Lightwheel®. If **Yes** has been selected and confirmed by pressing the right button (✓), the function is deleted and available under **Add new function** again. The corresponding relays are available again.

## Bypass

Bypass	
▶ Collector	1,2
Relay	R4
Variant	Pump

Variant pump:

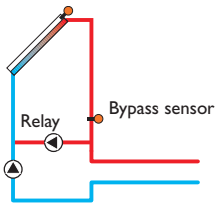

Variant valve:

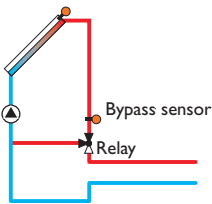

Variant valve (inverted):

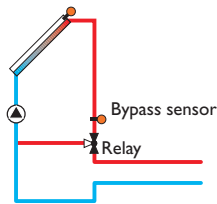

Exemplary schematics for the bypass variants

### Solar/Opt. functions/Add new function/Bypass

Adjustment channel	Description	Adjustment range/ selection	Factory setting
Collector	Collector field	system dependent	system dependent
Relay	Bypass relay	system dependent	system dependent
Variant	Variant (pump or valve logic)	Pump,Valve	Pump
Inverted	Valve logic inversion	Yes, No	No
Sensor	Bypass sensor	system dependent	system dependent
$\Delta T_{on}$	Bypass switch-on temperature difference	1.0 ... 20.0 K	6.0 K
$\Delta T_{off}$	Bypass switch-off temperature difference	0.5 ... 19.5 K	4.0 K
Funct.	Activation / Deactivation	Activated, Deactivated, Switch	Activated
Sensor	Sensor input allocation	-	-
Save / Delete function	Save / Delete function	-	-

The **Bypass function** can be used to avoid an energy loss from the store directly after loading has started. The still cold heat transfer medium in the pipework is diverted through a bypass past the store. Once the pipe is warm enough, the store can be loaded.

Variant	
<input type="radio"/> Valve	
▶ <input checked="" type="radio"/> Pump	

Depending on whether the bypass is energised by a valve or by a second pump, a corresponding adjustment can be made in the menu item **Variant**. Depending on the variant, different control logics are applied:

#### Pump:

In this version, a bypass pump is placed in front of the collector pump.

The bypass pump is first activated when store loading is possible. If the temperature difference between the bypass sensor and the store sensor reaches the bypass switch-on temperature difference, the bypass pump is switched off and the solar pump is switched on instead.

#### Valve:

A bypass valve is placed into the solar circuit.

The solar heat exchanger is first bypassed when store loading is possible. If the temperature difference between the bypass sensor and the store sensor reaches the bypass switch-on temperature difference, the bypass relay operates the valve and solar loading starts.

When the valve variant is selected, the option Inverted is additionally available. When the Inverted option is activated and the bypass circuit becomes activated, the relay switches on. If the temperature difference between the bypass sensor and the store sensor reaches the bypass switch-on temperature difference, the relay switches off.



## External heat exchanger

Ext. HX	
▶ Relay	R4
Min speed	30%
Store	1,2

## Solar/Opt. functions/Add new function/Ext. HX

Adjustment channel	Description	Adjustment range/selection	Factory setting
Relay	Relay selection	system dependent	system dependent
Min. speed	Minimum speed	(20) 30...100%	30%
Store	Store sensor selection	system dependent	all stores
Sen. Ext. HX	Reference sensor ext. HX	system dependent	system dependent
Target temperature	Target temperature option	Yes, No	No
Sensor	Target temperature reference sensor	system dependent	system dependent
Target temp.	Target temperature	15...95°C	60°C
ΔTon	Switch-on temperature difference	1.0...20.0K	10.0K
ΔToff	Switch-off temperature difference	0.5...19.5K	5.0K
Overrun	Overrun time	0...15 min	2 min
Save/Delete function	Save/Delete function	-	-

This function is used to link loading circuits that are separated by an external heat exchanger.

The allocated relay is energised if one of the selected stores is being loaded and there is a temperature difference between the sensor of the corresponding store and the solar flow.

The relay is switched off if this temperature difference falls below the adjusted switch-off difference.

In contrast to the bypass function, a differential control between Sen. Ext. HX and the store temperature can be carried out by means of the heat exchanger relay.

The reference sensor can be arbitrarily allocated.

In System 3, variant 2, the heat exchanger relay operates the primary circuit pump.

The heat exchanger is protected by a non-adjustable antifreeze function.



### Note:

Because of the special hydraulics in systems with 2 collectors, the target temperature function will not work properly there.



### Note:

The heat exchanger is protected by a non-adjustable antifreeze function. Using a bypass is recommended nevertheless.

## Tube collector function

Tube collector	
▶ Start	08:00
Stop	19:00
Run	30 s

### Solar/Opt. functions/Add new function/Tube collector

Adjustment channel	Description	Adjustment range/ selection	Factory setting
Start	Start time frame	00:00 ... 23:00	08:00
Stop	Stop time frame	00:30 ... 23:30	19:00
Run	Pump runtime	5 ... 600 s	30 s
Pause	Standstill interval	1 ... 60 min	30 min
Delay	Pump delay	5 ... 600 s	15 s
Collector	Collector field	system dependent	system dependent
Stmax off	Maximum store temperature off	Yes, No	Yes
Funct.	Activation/Deactivation	Activated, Deactivated, Switch	Activated
Sensor	Sensor input allocation	-	-
Save/Delete function	Save/Delete function	-	-

This function is used for improving the switch-on behaviour in systems with non-ideal sensor positions (e. g. with some tube collectors).

This function operates within an adjusted time frame. It activates the collector circuit pump for an adjustable runtime between adjustable pauses in order to compensate for the delayed temperature measurement.

If the runtime is set to more than 10 s, the pump will be run at 100% for the first 10 s of the runtime. For the remaining runtime, the pump will be run at the adjusted minimum speed.

If the collector sensor is defective or the collector is blocked, this function is suppressed or switched off. If the **Stmax off** option is activated and the temperature of the store to be loaded exceeds the maximum store temperature, the tube collector function will be suppressed.

### 2-collector systems

In 2-collector systems, the tube collector function is available for each individual collector field.

The tube collector function will remain inactive for a collector field which is used for solar loading.

## Target temperature

Target temp.	
Targ. temp.	65 °C
▶ Sensor	S3
Rise	2.0 K

### Solar/Opt. functions/Add new function/Target temperature

Adjustment channel	Description	Adjustment range/ selection	Factory setting
Target temp.	Target temperature	20 ... 110 °C	65 °C
Sensor	Reference sensor	system dependent	system dependent
Rise	Rise value	1.0 ... 20.0K	2.0K
Funct.	Activation/Deactivation	Activated, Deactivated, Switch	Activated
Sensor	Sensor input allocation	-	-
Save/Delete function	Save/Delete function	-	-

When the **Target temperature** function is activated, the pump speed control logic changes. The controller will remain at the minimum pump speed until the temperature at the allocated sensor exceeds the adjusted target temperature. Only then will the standard pump speed control start to operate. If the temperature at the allocated sensor changes by 1/10 of the adjusted Rise value, the pump speed will be adjusted correspondingly.

If the **Ext. HX** (see p. 30) function has been activated, too, the target temperature control will pause while the external heat exchanger is loaded. While the external heat exchanger is loaded, its own pump speed control will come into effect.

## Antifreeze

Antifreeze	
▶ Frost on	4 °C
Frost off	6 °C
Collector	1,2

### Solar/Opt. functions/Add new function/Antifreeze

Adjustment channel	Description	Adjustment range/ selection	Factory setting
Frost on	Antifreeze switch-on temperature	-40 ... +15 °C	+4 °C
Frost off	Antifreeze switch-off temperature	-39 ... +16 °C	+6 °C
Collector	Collector field	system dependent	system dependent
Store (1,2)	Store succession order	system dependent	system dependent
Funct.	Activation/Deactivation	Activated, Deactivated, Switch	Activated
Sensor	Sensor input allocation	-	-
Save/Delete function	Save/Delete function	-	-

The Antifreeze function activates the loading circuit between the collector and the store when the temperature falls below the adjusted antifreeze switch-on temperature. This will protect the fluid against freezing or coagulating. If the antifreeze switch-off temperature is exceeded, the solar pump will be switched off again.

Heat will be extracted from the stores according to the adjusted order. When all stores have reached their minimum temperature of 5 °C, the function becomes inactive.

If the function is activated, the pump is run at its maximum relative speed.



#### Note:

In systems with east-/west collectors, 2 separate menus will be displayed.

## Afterheating suppression

AH suppress.	
▶ Relay	R4
Store	1,2
<input type="checkbox"/> Tset	

### Solar/Opt. functions/Add new function/AH suppression

Adjustment channel	Description	Adjustment range/ selection	Factory setting
Relay	Reference relay	system dependent	system dependent
Store	Store sensor selection	system dependent	system dependent
Tset	Set temperature	Yes, No	No
Funct.	Activation/Deactivation	Activated, Deactivated, Switch	Activated
Sensor	Sensor input allocation	-	-
Save/Delete function	Save/Delete function	-	-

The **Afterheating suppression** blocks the conventional afterheating of a store that is currently in solar loading.

This function is activated if a previously selected store is being loaded.

Solar loading means that store loading is only carried out for energy supply and not for cooling purposes etc.

If the **Tset** option is activated, the afterheating will only be suppressed when the store temperature exceeds **Tset**.

## Parallel relay

Parallel relay	
Relay	R4
Store	1
Funct.	Activated

### Solar/Opt. functions/Add new function/Parallel relay

Adjustment channel	Description	Adjustment range/ selection	Factory setting
Relay	Parallel relay	system dependent	system dependent
Store	Store sensor selection	system dependent	system dependent
Funct.	Activation / Deactivation	Activated, Deactivated, Switch	Activated
Sensor	Sensor input allocation	-	-
Save/Delete function	Save / Delete function	-	-

With this function, e. g. a valve can be controlled in parallel to a solar pump via a separate relay.

Switch-on condition for the solar parallel relay function is that one or more of the selected stores is being loaded. If at least one of the selected stores is being loaded, the parallel relay is energised.

The parallel relay function operates regardless whether the store is subjected to regular solar loading or to a loading caused by an optional function (such as the collector cooling).



#### Note:

If a relay is in the manual mode, the selected parallel relay will not be energised.

## Cooling mode

Cooling mode	
Var.	Off
Store 1	-
Store 2	-

### Solar/Opt. functions/Add new function/Cooling mode

Adjustment channel	Description	Adjustment range/ selection	Factory setting
Variant	Cooling logic variant	Col. cool, Syst. cool., Off	Off
Tcolmax.	Collector maximum temperature	70 ... 190 °C	100 °C
Store (1,2)	Store succession order	system dependent	system dependent
St cooling	Store cooling	Yes, No	No
ΔTon	Switch-on temperature difference	1.0 ... 30.0 K	20.0 K
ΔToff	Switch-off temperature difference	0.5 ... 29.5 K	15.0 K
Funct.	Activation / Deactivation	Activated, Deactivated, Switch	Activated
Sensor	Sensor input allocation	-	-
Save/Delete function	Save / Delete function	-	-

In the **Cooling mode** menu, different cooling functions are available. They can be used for keeping the solar system operational for a longer time during strong solar irradiation.

For this purpose, the adjusted maximum store temperatures can be exceeded. The store order for this overloading can be adjusted. Additionally, each individual store can be excluded from this function.

2 different variants are available for the cooling mode: the system cooling and the collector cooling.

#### System cooling:

If the system cooling variant has been selected and the switch-on temperature difference is exceeded, store loading is continued even if the corresponding maximum temperature is exceeded, but only up to the emergency shutdown temperature. Store loading continues until all stores have reached the emergency shutdown temperature or until the switch-off temperature difference is reached.

### Collector cooling:

If the collector cooling variant has been selected, store loading is continued or reactivated when the collector maximum temperature is exceeded.

Store loading continues until all stores have reached the emergency shutdown temperature or until the collector temperature falls below the collector maximum temperature by at least 5K.

In 2-collector systems, separate adjustments can be made for each collector field.

The control logic regards collector cooling operation as solar loading. The adjusted values for delay, minimum runtime, etc. remain valid.

### Store cooling option:

When the store cooling function is activated, the controller aims to cool down the store during the night in order to prepare it for solar loading on the following day.

When the store cooling function is activated, the solar pump is switched on if the maximum store temperature is exceeded and the collector temperature falls below the store temperature. The solar pump remains active until the store temperature falls below the adjusted maximum store temperature.

The store order for the cooling is the same as in the overheating through system- or collector cooling.

### Drainback option

Drainback	
▶ Filling time	5 min
Stab. time	2.0 min
Initialis.	60 s

### Solar/Opt. functions/Add new function/Drainback

Adjustment channel	Description	Adjustment range/ selection	Factory setting
Filling time	Drainback filling time	1 ... 30 min	5 min
Stab. time	Stabilisation time	1.0 ... 15.0 min	2.0 min
Initialis.	Initialisation time	1 ... 100 s	60 s
Booster	Booster option	Yes, No	No
Relay	Booster pump relay selection	system dependent	system dependent
Drain impulse	Drain impulse option	Yes, No	No
Delay	Delay time	1 ... 30 min	3 min
Duration	Drain impulse loading duration	1 ... 60 s	10 s
Funct.	Activation / Deactivation	Activated, Deactivated, Switch	Activated
Sensor	Sensor input allocation	-	-
Save/Delete function	Save / Delete function	-	-

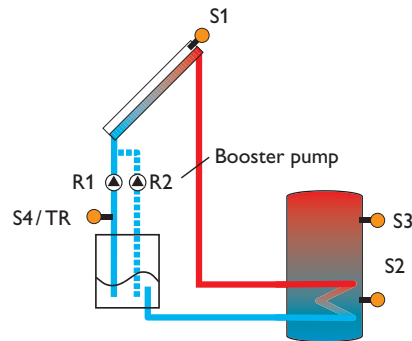

Exemplary drainback system layout (R2 = booster pump)

In a drainback system the heat transfer fluid will flow into a holding tank if solar loading does not take place. The drainback option initiates the filling process if solar loading is about to start. If the drainback option is activated, the following adjustment can be made:



**Note:**

A drainback system requires additional components such as a holding tank. The drainback option should only be activated if all components required are properly installed.

**Time period - switch-on condition**

The parameter **Initialis.** is used for adjusting the time period during which the switch-on condition must be permanently fulfilled.

**Filling time**

The filling time can be adjusted using the parameter **Filling time.** During this period, the pump runs at maximum speed.

**Stabilisation**

The parameter **Stab. time** is used for adjusting the time period during which the switch-off condition will be ignored after the filling time has ended.

The **Booster** option is used for switching on a second pump when filling the solar system. The corresponding relay is switched on at 100% speed for the duration of the filling time.

A short time (**Delay time**) after the system has been emptied, the **Drain impulse** option will switch on the solar pump for an adjustable **Duration.** Thus, a hydrostatic head will form in the flow pipe. When it falls back into the holding tank, water pockets remaining in the collector will be sucked down into the holding tank.

**Twin pump**

Twin pump	
Relay	R4
Ref. relay	R1
Runtime	6 h

**Solar/Opt. functions/Add new function/Twin pump**

Adjustment channel	Description	Adjustment range/selection	Factory setting
Relay	Relay selection twin pump	system dependent	system dependent
Reference relay	Reference relay selection	system dependent	-
Runtime	Pump runtime	1 ... 48 h	6 h
Flow rate mon.	Flow rate monitoring option	Yes, No	No
Flow rate sen.	Flow rate sensor selection	S5, S6, S7	-
Delay	Delay time	1 ... 10 min	5 min
Funct.	Activation/Deactivation	Activated, Deactivated, Switch	Activated
Sensor	Sensor input allocation	-	-
Save/Delete function	Save/Delete function	-	-

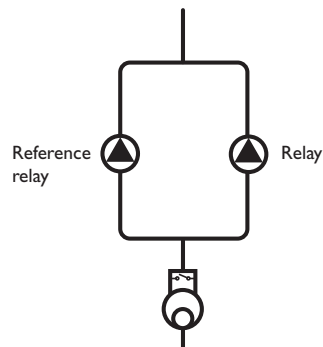

Exemplary figure of twin pumps with upstream flowmeter

The **Twin pump** function controls the equal distribution of pump runtime in systems with 2 equally usable pumps.

If the selected reference relay has exceeded its adjusted runtime and the next switch-on process is imminent, the allocated relay (twin pump) is switched on instead. All characteristics are adopted.

If the allocated relay has in turn exceeded its runtime as well, the selected reference relay is switched on again in the next switch-on process.

Additionally, the flow rate monitoring option can be activated in order to activate the twin pump in the case of a flow rate error. When the flow rate monitoring option is activated, 2 additional adjustment channels appear for allocating a sensor and adjusting a delay time.

If the flow rate monitoring option is activated, an error message will appear when no flow rate is detected at the allocated sensor after the delay time has elapsed. The active relay will be blocked as defective and the second relay will be activated instead. The twin pump function will pause until the error message has been acknowledged.

When the error message is acknowledged, the controller runs a test during which it will energise the relay and again monitor the flow rate.

## Heat dump

Heat dump	
▶ Relay	R4
Variant	Valve
ΔTvalve	3.0 K

## Solar / Opt. functions / Add new function / Heat dump

Adjustment channel	Description	Adjustment range / selection	Factory setting
Relay	Relay selection	system dependent	system dependent
Variant	Variant (pump or valve logic)	Valve, Pump	Valve
ΔTvalve	Valve logic temperature difference	0.0 ... 10.0 K	3.0 K
Collector	Collector selection	system dependent	1
Tcol.	Collector overtemperature	40 ... 190 °C	110 °C
Funct.	Activation / Deactivation	Activated, Deactivated, Switch	Activated
Sensor	Sensor input allocation	-	-
Save / Delete function	Save / Delete function	-	-

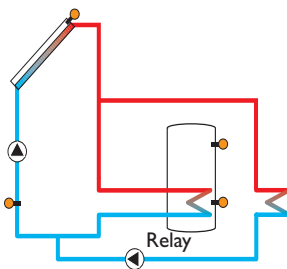

**Variant pump**

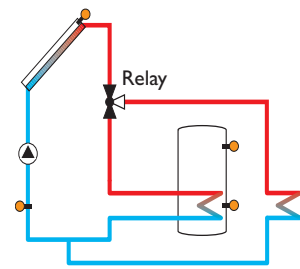

**Variant valve**



### Note:

The switch-on collector temperature must be adjusted at least by 10K lower than the emergency switch-off temperature.

The **Heat dump function** can be used to direct excess heat generated by strong solar irradiation to an external heat exchanger (e. g. fan coil) in order to keep the collector temperature within the operating range.

Whether the heat dump is activated via an additional pump or a valve can be adjusted in the menu item **Variant**.

#### Variant pump:

The allocated relay is energised with 100%, if the collector temperature reaches the adjusted switch-on temperature.

If the collector temperature falls by 5K below the adjusted collector overtemperature, the relay will be switched off. In the variant pump, the heat dump function works independent from solar loading.

#### Variant valve:

If the collector temperature reaches the [**Tcol. -  $\Delta T$  valve**], the allocated relay switches on. This ensures that the valve has completed its motion before the pump is activated. If the collector temperature falls by 5K below the adjusted collector overtemperature, the relay will be switched off.

If one of the store temperatures exceeds its store maximum temperature while the heat dump function is active, the function will be deactivated and an error message will appear. If the temperature falls below this value by the hysteresis maximum store temperature (**HysSt** in the Solar/Basic settings/Store menu), the heat dump function is released again.

#### Flow rate monitoring

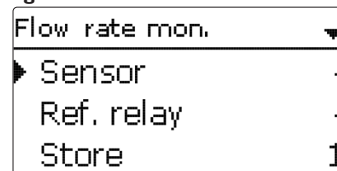

#### Solar/Opt. functions/Add new function/Flow rate mon.

Adjustment channel	Description	Adjustment range/ selection	Factory setting
Sensor	Flow rate sensor selection	system dependent	-
Ref. relay	Reference relay selection	system dependent	-
Store	Store sensor selection	system dependent	1
Time	Delay time	1 ... 300s	30 s
Funct.	Activation/Deactivation	Activated, Deactivated, Switch	Activated
Sensor	Sensor input allocation	-	-
Save/Delete function	Save/Delete function	-	-

The **Flow rate monitoring** function can be used for detecting malfunctions that impede the flow rate and to switch off the corresponding relay. This will prevent system damage, e. g. through a dry run of the pump.

If the flow rate monitoring function is activated, an error message will appear when no flow rate is detected at the allocated flowmeter after the delay time has elapsed.

- If a reference relay has been selected, the flow rate monitoring function will become active when the allocated relay is switched on. In the case of an error, the complete solar system will be shut down.
- If both a store and a reference relay have been selected, the flow rate monitoring function will become active when the allocated relay is switched on. In the case of an error, the allocated store will be blocked until the error message has been acknowledged. The next store free for loading will be loaded instead.

The error message will appear both in the **Status/ Messages** menu and in the **Status/Solar/Flow rate mon.** menu. It can be acknowledged in the **Status/Solar/Flow rate mon.** menu. When the error message is acknowledged, the controller runs a test during which it will energise the relay and again monitor the flow rate.



## Pressure monitoring

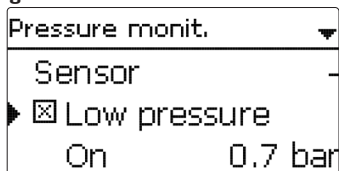

### Note:

The pressure monitoring function will only be available when an RPS type Grundfos Direct Sensor™ is connected.

## Solar/Opt. functions/Add new function/Pressure monitoring

Adjustment channel	Description	Adjustment range / selection	Factory setting
Sensor	Pressure sensor selection	S6	-
Low pressure	Low pressure monitoring option	Yes, No	No
On	Switch-on threshold	0.0 ... 9.7 bar	0.7 bar
Off	Switch-off threshold	0.1 ... 9.8 bar	1.0 bar
Shutdown	Shutdown option	Yes, No	No
Overpressure	Overpressure monitoring option	Yes, No	No
On	Switch-on threshold	0.3 ... 10.0 bar	5.5 bar
Off	Switch-off threshold	0.2 ... 9.9 bar	5.0 bar
Shutdown	Shutdown option	Yes, No	No
Funct.	Activation/Deactivation	Activated, Deactivated, Switch	Activated
Sensor	Sensor input allocation	-	-
Save/Delete function	Save/Delete function	-	-

The **Pressure monitoring** function can be used for detecting overpressure or low pressure conditions inside the system, and if necessary to shut down the affected system components in order to avoid system damage.

## Low pressure

If the system pressure falls below the adjustable switch-on value **On**, an error message will appear.

If the **Shutdown** option has been activated for the low pressure monitoring function, the solar system will be shut down as well in the case of a fault condition.

When the pressure reaches or exceeds the adjustable switch-off value **Off**, the system is switched on again.



### Note:

For the **Low pressure** monitoring function, **Off** always is at least 0.1 bar higher than **On**. The corresponding adjustment ranges will automatically adapt to that.

## Overpressure

If the system pressure exceeds the adjustable switch-on value **On**, an error message will appear.

If the **Shutdown** option has been activated for the overpressure monitoring function, the solar system will be shut down as well in the case of a fault condition.

When the pressure reaches or falls below the adjustable switch-off value **Off**, the system is switched on again.



### Note:

For the **Overpressure** monitoring function, **On** always is at least 0.1 bar higher than **Off**. The corresponding adjustment ranges will automatically adapt to that.

## Function control

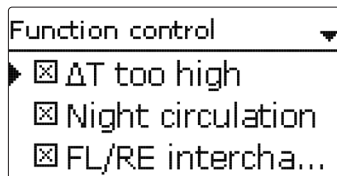

### Note:

Only if the installer code is entered (see page 60), will the **Function control** menu be available.

## Solar/Function control

Adjustment channel	Description	Adjustment range/selection	Factory setting
ΔT too high	Option ΔT monitoring	Yes, No	No
Night circulation	Night circulation monitoring option	Yes, No	No
FL/RL interchanged	FL/RE interchange monitoring option	Yes, No	No
Store max. temp.	Maximum store temperature monitoring option	Yes, No	No
Store	Store sensor selection	system dependent	system dependent

## ΔT monitoring function

This function can be used for monitoring the temperature difference. The message **ΔT too high** is shown, if solar loading has been carried out for a period of 20 minutes with a differential higher than 50K. Normal operation is not aborted or inhibited, but the system should be checked for the cause of the warning.

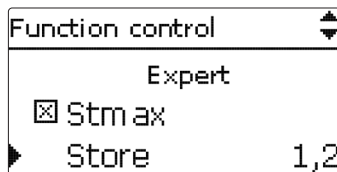

Possible causes are:

- pump power too weak
- hydraulic blockage of a system component
- circulation problems in the collector
- air inside the system
- defective valve / defective pump

## Night circulation

This function can be used for detecting thermal circulation inside the solar circuit that leads to an unwanted cooling of the store. A warning message will appear when one of the following conditions has been detected for at least 1 min during the period between 11 p.m. and 5 a.m.:

- collector temperature exceeds 40 °C
- the temperature difference exceeds ΔTon

The delay time of 1 min ensures that the message is not triggered by short-term fault conditions.

Possible causes are:

- defective non-return valves
- defective valve
- wrongly adjusted time

## Flow and return pipe interchanged

This function is used for detecting an interchange of the flow and return pipe or a badly placed collector sensor. For this purpose, the collector temperature is monitored for plausibility during the switch-on phases of the solar pump. The message **FL/RE interchanged** will appear, when the plausibility criteria have not been met 5 times in a row.

## Maximum store temperature

This function is used for detecting and indicating if the adjusted maximum store temperature has been exceeded. The controller compares the current store temperature to the adjusted maximum store temperature, thus monitoring the store loading circuits.

The maximum store temperature is considered exceeded when the temperature measured at the store sensor exceeds the adjusted maximum store temperature by at least 5 K. The monitoring becomes active again as soon as the store temperature falls below the adjusted maximum store temperature.

In the **Store** channel, the store or stores to be monitored can be selected.

A possible cause for an unwanted exceedance of the maximum store temperature is a defective valve.

### 8.3 Holiday function

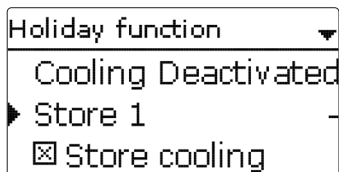

#### Solar/Holiday function

Adjustment channel	Description	Adjustment range/ selection	Factory setting
Cooling	Cooling logic variant	Deactivated, System cooling, Collector cooling	Deactivated
Tcolmax.	Collector maximum temperature	70...190 °C	100 °C
Store (1,2)	Store succession order	system dependent	system dependent
Store cooling	Store cooling option	Yes, No	Yes
ΔTon	Switch-on temperature difference	1.0...30.0 K	20.0 K
ΔToff	Switch-off temperature difference	0.5...29.5 K	15.0 K
Stmax (1,2)	Store cooling temperature	4...95 °C	40 °C
Heat dump	Store heat dump	Yes, No	No
Relay	Relay selection	system dependent	-
Sensor	Sensor selection	system dependent	-
TStoreOn	Switch-on temperature	5...95 °C	65 °C
TStoreOff	Switch-off temperature	4...94 °C	45 °C

The **Holiday function** is used for operating the system when no water consumption is expected, e. g. during a holiday absence. This function cools down the system in order to reduce the thermal load.

Only if the holiday function has been activated with the parameter **Days of absence** will the adjustments described in the following become active.

The parameter **Days of absence** can be used for entering the number of days for a holiday absence.

If the parameter is set to a value higher than 0, the function becomes active using the adjustments that have previously been made in the **Holiday** menu. The days will be counted backwards at 00:00. If the value is set to 0, the function is deactivated.

4 different cooling functions are available: System cooling, Collector cooling, Store cooling and Store heat dump.

#### System cooling:

If the system cooling variant has been selected and the switch-on temperature difference is exceeded, store loading is continued even if the corresponding maximum temperature is exceeded, but only up to the emergency shutdown temperature. Store loading continues until all stores have reached the emergency shutdown temperature or until the switch-off temperature difference is reached.

#### Collector cooling:

If the collector cooling variant has been selected, store loading is continued or reactivated when the collector maximum temperature is exceeded.

Store loading continues until all stores have reached the emergency shutdown temperature or until the collector temperature falls below the collector maximum temperature by at least 5 K. In 2-collector systems, separate adjustments can be made for each collector field.

The control logic regards collector cooling operation as solar loading. The adjusted values for delay, minimum runtime, etc. remain valid.

#### Store cooling:

When the store cooling function is activated, the controller aims to cool down the store during the night in order to prepare it for solar loading on the following day.

When the store cooling function is activated, the solar pump is switched on if the maximum store temperature is exceeded and the collector temperature falls below the store temperature. The solar pump remains active until the store temperature falls below the adjusted maximum store temperature.

The store order for the cooling is the same as in the overheating through system- or collector cooling.

The store heat dump function can be used to direct excess heat generated by strong solar irradiation from the store to an external heat exchanger (e. g. fan coil) or radiator in order to prevent the collectors from overheating. The store heat dump function is independent of the solar system and can be activated with the parameter **Heat dump**. The function uses the adjustable switch-on and switch-off temperature differences **TStoreOn** and **TStoreOff**.

If the temperature measured at the sensor selected reaches the switch-on temperature, the relay selected will be energised until the temperature difference falls below the switch-off value.



#### Note:

The parameter **Days of absence** can be accessed via the microbutton  only (see page 11).



#### Note:

The adjustments described in this chapter are independent of those in the Cooling mode menu, which are inactive during days of absence.

## 8.4 Solar expert menu

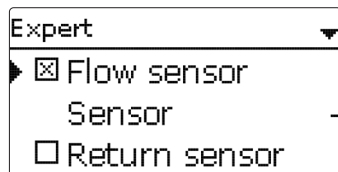

### Solar/Expert

Adjustment channel	Description	Adjustment range/selection	Factory setting
Flow sensor	Flow sensor option	Yes, No	No
Sensor	Flow sensor selection	system dependent	-
Return sensor	Return sensor option	Yes, No	No
Sensor	Return sensor selection	system dependent	-

The **Expert** menu is only available when the installer user code has been entered. In the expert menu, a flow and a return sensor can be selected and allocated. The activated sensors are then used to detect the switch-off condition.

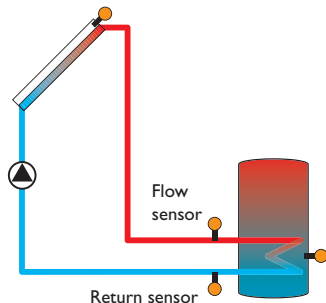

Example of flow and return sensor positions



#### Note:

Because of the special hydraulics in systems with 2 collectors, this function will not work properly there.

## 9 Arrangement

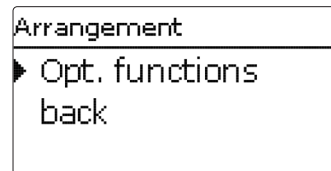

In this menu, all adjustments for the non-solar part of the arrangement can be made. A range of optional functions can be selected and adjusted.

### 9.1 Optional functions

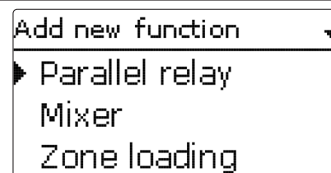

In this menu, optional functions can be selected and adjusted for the arrangement. By selecting **Add new function**, different pre-programmed functions can be selected. The optional functions are available as long as free relays are available.

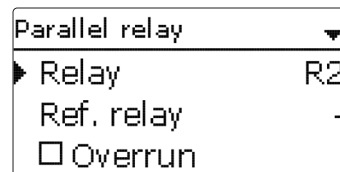

When a function is selected, a sub-menu opens in which all adjustments required can be made.

With this sub-menu, a relay and, if necessary, certain system components can be allocated to the function.

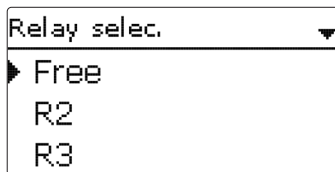

The menu item **Relay** is available in almost all optional functions. Therefore, it will not be explained in the individual function descriptions.

With this menu item, a relay can be allocated to the function. All free relays are available for selection.

If **Free** is selected, the function will run normally in the software but will not operate a relay.

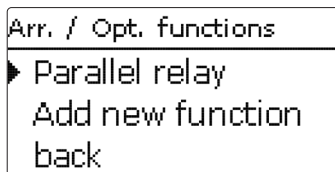

When a function has been adjusted and saved, it will appear in the **Opt. functions** menu above the menu item **Add new function**.

This allows an easy overview of functions already activated.

An overview about which sensor has been allocated to which component and which relay has been allocated to which function is given in the **Status/Service** menu.

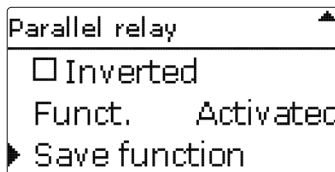

At the end of each optional function sub-menu, the menu items **Function** and **Save function** are available.

In order to save a function, select **Save function** and confirm the security enquiry by selecting **Yes**. In functions already saved, the menu item **Delete function** appears instead.

In order to delete a function already saved, select **Delete function** and confirm the security enquiry by selecting **Yes**.

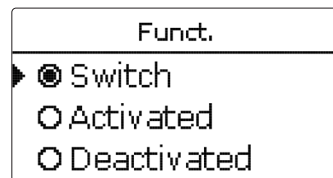

With the menu item **Function**, an optional function already saved can be temporarily deactivated or re-activated respectively. In this case, all adjustments will remain stored, the allocated relays remain occupied and cannot be allocated to another function.

By selecting **Switch**, the function can be activated or deactivated respectively by means of an external switch.

If Switch is selected, the channel Sensor will appear. In this channel, the sensor input to which the switch is to be connected can be allocated to the function.

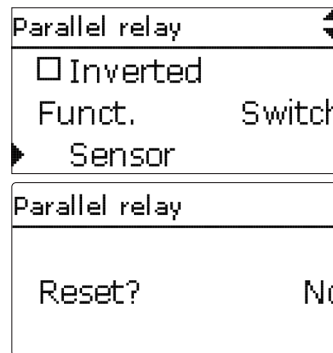

If the menu item **Delete function** is confirmed by pressing the right button (✓), a security enquiry appears. The setting can be changed between **Yes** and **No** by turning the Lightwheel®. If **Yes** has been selected and confirmed by pressing the right button (✓), the function is deleted and available under **Add new function** again. The corresponding relays are available again.

## Parallel relay

Parallel relay ▼	
Relay	R2
Ref. relay	R4
<input checked="" type="checkbox"/> Overrun	



### Note:

If a relay is in the manual mode, the selected parallel relay will not be energised.

## Arrangement/Opt. functions/Add new function/Parallel relay

Adjustment channel	Description	Adjustment range/ selection	Factory setting
Relay	Relay selection	system dependent	system dependent
Reference relay	Reference relay selection	system dependent	-
Overrun	Overrun option	Yes, No	No
Duration	Overrun time	1 ... 30 min	1 min
Delay	Delay option	Yes, No	No
Duration	Delay time	1 ... 30 min	1 min
Speed	Speed option	Yes, No	No
Inverted	Inverted switching option	Yes, No	No
Funct.	Activation/Deactivation	Activated, Deactivated, Switch	Activated
Sensor	Sensor input allocation	-	-
Save/Delete function	Save/Delete function	-	-

The **Parallel relay** function can be used to operate an allocated parallel relay alongside a selected reference relay. With this function, e.g. a valve can be controlled in parallel to the pump via a separate relay.

If the **Overrun** option is activated, the parallel relay remains switched on for the adjusted overrun time after the reference relay has been switched off.

If the **Delay** option is activated, the parallel relay will be energised after the adjusted delay time has elapsed. If the reference relay is switched off again during the delay time, the parallel relay will not be switched on at all.

When the **Speed** option has been activated, the Relay will assume the pump speed information for the Reference relay. If the Inverted option is activated at the same time, the relay will only switch on/off without pump speed control.

If the **Inverted** option is activated, the parallel relay switches on when the reference relay switches off and vice versa.

## Mixer

Mixer ▼	
Relay closed	R2
Relay open	R3
Sensor	S3

## Arrangement/Opt. functions/Add new function/Mixer

Adjustment channel	Description	Adjustment range/ selection	Factory setting
Relay closed	Relay selection mixer closed	system dependent	system dependent
Relay open	Relay selection mixer open	system dependent	system dependent
Sensor	Sensor selection	system dependent	system dependent
TMixer	Mixer target temperature	0 ... 130 °C	60 °C
Interval	Mixer interval	1 ... 20 s	4 s
Funct.	Activation/Deactivation	Activated, Deactivated, Switch	Activated
Sensor	Sensor input allocation	-	-
Save/Delete function	Save/Delete function	-	-

The **Mixer** function can be used to adjust the actual flow temperature to the desired mixer target temperature. The mixer is opened or closed in pulses depending on this deviation. The pulses are determined by the adjustable **Interval**. The pause is determined by the difference between the actual value and the set value.

## Zone loading

Zone loading	
▶ Relay	R2
Sensor top	S3
Sensor base	S4

### Arrangement/Opt. functions/Add new function/Zone loading

Adjustment channel	Description	Adjustment range/ selection	Factory setting
Relay	Relay selection	system dependent	system dependent
Sensor top	Top sensor selection	system dependent	system dependent
Sensor base	Base sensor selection	system dependent	system dependent
Ton	Switch-on temperature	0... 94 °C	45 °C
Toff	Switch-off temperature	1... 95 °C	60 °C
Timer	Timer option	Yes, No	No
Funct.	Activation/Deactivation	Activated, Deactivated, Switch	Activated
Sensor	Sensor input allocation	-	-
Save/Delete function	Save/Delete function	-	-

The **Zone loading** function can be used for loading a store zone between 2 sensors. For monitoring the switch-on and switch-off conditions, 2 sensors are used. The switch-on and switch-off temperatures Ton and Toff are used as reference parameters.

If the measured temperatures at both allocated sensors fall below the adjusted switching threshold Ton, the relay is energised. It is switched off again when the temperature at both sensors has exceeded Toff.

If one of the 2 sensors is defective, zone loading is suppressed or switched off.



#### Note:

For more information about timer adjustment, see page 13.

## Error relay

Error relay	
▶ Relay	R2
Funct.	Activated
Save function	

### Arrangement/Opt. functions/Add new function/Error relay

Adjustment channel	Description	Adjustment range/ selection	Factory setting
Relay	Relay selection	system dependent	system dependent
Funct.	Activation/Deactivation	Activated, Deactivated, Switch	Activated
Sensor	Sensor input allocation	-	-
Save/Delete function	Save/Delete function	-	-

The **Error relay** function can be used for operating a relay in the case of an error. Thus, e. g. a signalling device can be connected in order to signal errors.

If the error relay function is activated, the allocated relay will operate when a sensor fault occurs. If the flow rate monitoring function is additionally activated, the allocated relay will additionally operate in the case of a flow rate error.

## Heat exchange

Heat exchange	
Relay	R2
Sen. Source	S3
Sen. Sink	S4

### Arrangement/Opt. functions/Add new function/Heat exchange

Adjustment channel	Description	Adjustment range/selection	Factory setting
Relay	Relay selection	system dependent	system dependent
Sen. Source	Heat source sensor selection	system dependent	system dependent
Sen. Sink	Heat sink sensor selection	system dependent	system dependent
$\Delta T_{on}$	Switch-on temperature difference	1.0 ... 30.0K	6.0K
$\Delta T_{off}$	Switch-off temperature difference	0.5 ... 29.5K	4.0K
$\Delta T_{set}$	Set temperature difference	1.5 ... 40.0K	10.0K
Min. speed	Minimum speed	(20) 30 ... 100%	100%
Tmax	Maximum temperature of the store to be loaded	10 ... 95 °C	60 °C
Tmin	Minimum temperature of the store to be loaded	10 ... 95 °C	10 °C
Timer	Timer option	Yes, No	No
Funct.	Activation /Deactivation	Activated, Deactivated, Switch	Activated
Sensor	Sensor input allocation	-	-
Save /Delete function	Save /Delete function	-	-

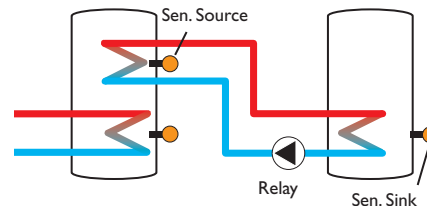

The **Heat exchange** function can be used for transferring heat from a heat source to a heat sink.

The allocated relay is energised when all switch-on conditions are fulfilled:

- the temperature difference between the allocated sensors has exceeded the switch-on temperature difference
- the temperature at the heat source sensor has exceeded the minimum temperature
- the temperature at the heat sink sensor has fallen below the maximum temperature

When the set temperature difference is exceeded, pump speed control starts. For every deviation of 0.2K, the pump speed will be adjusted by 1%.

When the **Timer** option is activated, a timer is indicated in which time frames for the function can be adjusted.



#### Note:

For more information about timer adjustment, see page 13.



## Solid fuel boiler

Solid fuel boiler ▾	
▶ Relay	R2
Sen. Boiler	S3
Sen. Store	S4

### Arrangement / Opt. functions / Add new function / Solid fuel boiler

Adjustment channel	Description	Adjustment range / selection	Factory setting
Relay	Relay selection	system dependent	system dependent
Sen. Boiler	Solid fuel boiler sensor selection	system dependent	system dependent
Sen. Store	Store sensor selection	system dependent	system dependent
ΔTon	Switch-on temperature difference	2.0 ... 30.0K	6.0K
ΔToff	Switch-off temperature difference	1.0 ... 29.0K	4.0K
ΔTset	Set temperature difference	3.0 ... 40.0K	10.0K
Min. speed	Minimum speed	(20) 30 ... 100%	100%
Tmax St.	Maximum temperature	10 ... 95 °C	60 °C
Tmin boiler	Minimum temperature	10 ... 95 °C	60 °C
Funct.	Activation / Deactivation	Activated, Deactivated, Switch	Activated
Sensor	Sensor input allocation	-	-
Save / Delete function	Save / Delete function	-	-

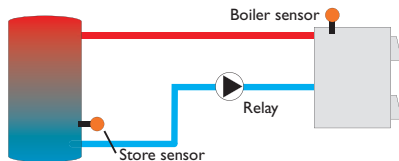

The **Solid fuel boiler** function can be used for transferring heat from a solid fuel boiler to a store.

The allocated relay is energised when all switch-on conditions are fulfilled:

- the temperature difference between the allocated sensors has exceeded the switch-on temperature difference
- the temperature at the solid fuel boiler sensor has exceeded the minimum temperature
- the temperature at the store sensor has fallen below the maximum temperature

When the set temperature difference is exceeded, pump speed control starts. For every deviation of 0.2K, the pump speed will be adjusted by 1%.

## Circulation

Circulation ▾	
Relay	R2
Type	Thermal
▶ Sensor	S3

### Arrangement / Opt. functions / Add new function / Circulation

Adjustment channel	Description	Adjustment range / selection	Factory setting
Relay	Relay selection	system dependent	system dependent
Type	Variant	Demand, Thermal, Timer, Therm.+Timer, Demand+Timer	Thermal
Sensor	Circulation sensor selection	system dependent	system dependent
Ton	Switch-on temperature	10 ... 59 °C	40 °C
Toff	Switch-off temperature	11 ... 60 °C	45 °C
Timer	Timer option	Yes, No	No
Sensor	FS08 sensor input selection	system dependent	system dependent
Delay	Demand switch-on delay	0 ... 3 s	0 s
Runtime	Circulation pump runtime	01:00 ... 15:00 min	03:00 min
Break time	Circulation pump break time	10 ... 60 min	30 min
Funct.	Activation / Deactivation	Activated, Deactivated, Switch	Activated
Sensor	Sensor input allocation	-	-
Save / Delete function	Save / Delete function	-	-

The **Circulation** function can be used for controlling a circulation pump.

For the control logic, 5 different variants are available:

- Thermal
- Timer
- Thermal + Timer
- Demand
- Demand + Timer

If one of the variants is selected, the corresponding adjustment channels will appear.

## Thermal

The temperature at the allocated sensor is monitored. The allocated relay switches on when the temperature falls below the adjusted switch-on temperature. If the temperature exceeds the switch-off temperature, the relay switches off.

## Timer

The relay is switched on during the adjusted time frames, outside of them it switches off. For information on how to adjust the timer, see below.

## Thermal + Timer

The relay operates when the switch-on conditions of both above mentioned variants are fulfilled.

## Demand

The allocated FS08 flow switch is monitored for circuit continuity. If circuit continuity is detected at the flow switch, the relay switches on for the adjusted runtime. After the runtime has ended, the relay is switched off. During the adjusted break time, the relay remains switched off even if continuity is detected at the flow switch.

## Demand + Timer

The relay operates when the switch-on conditions of both above mentioned variants are fulfilled. When the **Timer**, **Therm. + Timer** or **Demand + Timer** variant is activated, a timer is indicated in which time frames for the function can be adjusted.



### Note:

For more information about timer adjustment, see page 13.

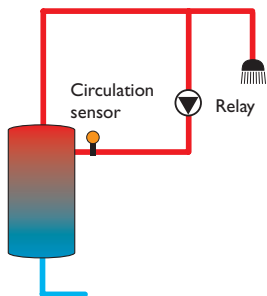

## Return preheating

Ret. preheat.	
Relay	R2
Sen. Return	S3
Sen. HS	S4

## Arrangement/Opt. functions/Add new function/Return preheating

Adjustment channel	Description	Adjustment range / selection	Factory setting
Relay	Relay selection	system dependent	system dependent
Sen. Return	Return sensor selection	system dependent	system dependent
Sen. Source	Heat source sensor selection	system dependent	system dependent
$\Delta$ Ton	Switch-on temperature difference	2.0 ... 30.0K	6.0K
$\Delta$ Toff	Switch-off temperature difference	1.0 ... 29.0K	4.0K
Summer off	Summer switch-off option	Yes, No	No
Sensor	Outdoor sensor selection	system dependent	system dependent
Toff	Switch-off temperature	10 ... 60 °C	20 °C
Funct.	Activation/Deactivation	Activated, Deactivated, Switch	Activated
Sensor	Sensor input allocation	-	-
Save/Delete function	Save/Delete function	-	-

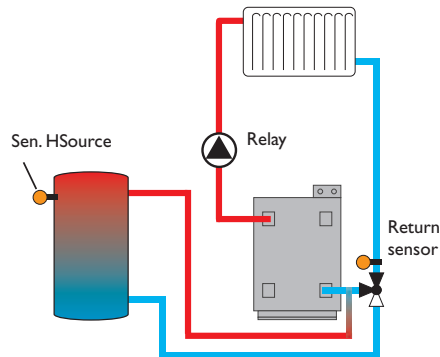

The **Return preheating** function can be used for transferring heat from a heat source to the heating circuit return.

The allocated relay is energised when both switch-on conditions are fulfilled:

- the temperature difference between the allocated sensors has exceeded the switch-on temperature difference
- the temperature at the outdoor temperature sensor has fallen below the adjusted outdoor temperature (valid only if the **Summer off** option has been activated)

With the summer switch-off option, the return preheating can be suppressed outside the heating period.

## Function block

Function block ▾

▶ Relay R2

Thermostat a

Thermostat b

## Arrangement / Opt. functions / Add new function / Function block

Adjustment channel	Description	Adjustment range / selection	Factory setting
Relay	Relay selection	system dependent	system dependent
Thermostat a	Option Thermostat a	Yes, No	No
Th-a on	Switch-on temperature Thermostat a	-40 ... +250 °C	+40 °C
Th-a off	Switch-off temperature Thermostat a	-40 ... +250 °C	+45 °C
Sensor	Sensor thermostat a	system dependent	system dependent
Thermostat b	Option Thermostat b	Yes, No	No
Th-b on	Switch-on temperature Thermostat b	-40 ... +250 °C	+40 °C
Th-b off	Switch-off temperature Thermostat b	-40 ... +250 °C	+45 °C
Sensor	Sensor thermostat b	system dependent	system dependent
ΔT function	Differential function	Yes, No	No
ΔTon	Switch-on temperature difference	1.0 ... 50.0 K	5.0 K
ΔToff	Switch-off temperature difference	0.5 ... 49.5 K	3.0 K
ΔTset	Set temperature difference	3 ... 100 K	10 K
Min. speed	Minimum speed	(20) 30 ... 100 %	30 %
Sen. Source	Heat source sensor	system dependent	system dependent
Sen. Sink	Heat sink sensor	system dependent	system dependent
Timer	Timer option	Yes, No	No
Reference relay	Reference relay option	Yes, No	No
Mode	Reference relay mode	OR, AND, NOR, NAND	OR
Relay	Reference relay 1	all relays	-
Relay	Reference relay 2	all relays	-
Relay	Reference relay 3	all relays	-
Funct.	Activation / Deactivation	Activated, Deactivated, Switch	Activated
Sensor	Sensor input allocation	-	-
Save / Delete function	Save / Delete function	-	-

In addition to the pre-defined optional functions, function blocks consisting of thermostat functions, timers, differential functions and reference relays are available. With the help of these function blocks, further components, resp. functions can be controlled.

To each function block, sensors and free relays can be allocated. Sensors already in use can be allocated again without impeding their control functions.

Within a function block the functions are interconnected (AND gate). This means that the switching conditions of all the activated functions have to be fulfilled (e. g. thermostat and timer) for switching the allocated relay. As soon as one condition is not fulfilled, the relay is switched off.

### Thermostat function

The switch-on condition for the thermostat function is considered fulfilled when the adjusted switch-on temperature (Th(x) on) is reached.

It is considered unfulfilled when the adjusted switch-off temperature (Th(x)off) is reached.

Allocate the reference sensor in the **Sensor** channel.

Adjust the maximum temperature limitation with Th(x)off> Th(x)on and the minimum temperature limitation with Th(x)on> Th(x)off. The temperatures cannot be set to an identical value.

### $\Delta T$ function

The switch-on condition for the  $\Delta T$  function is considered fulfilled when the adjusted switch-on temperature ( $\Delta T(x)$  on) is reached.

It is considered unfulfilled when the adjusted switch-off temperature ( $\Delta T(x)$ off) is reached.

The  $\Delta T$  function is equipped with a speed control function. A set temperature difference and a minimum speed can be adjusted. The non-adjustable rise value is 2 K.

### Reference relay

Up to 3 reference relays can be selected. Whether the reference relays are to be switched in series (AND), in parallel (OR), in series inverted (NAND) or in parallel inverted (NOR) can be adjusted in the **Mode** channel.

In the OR mode, the switch-on condition for the reference relay function is considered fulfilled when at least one of the reference relays is active.

If none of the reference relays is active, the switch-on condition for the reference relay function is considered unfulfilled.

In the NOR mode, the switch-on condition for the reference relay function is considered fulfilled when none of the reference relays is active.

As soon as at least one of the reference relays is active, the switch-on condition for the reference relay function is considered unfulfilled.

In the AND mode, the switch-on condition for the reference relay function is considered fulfilled when none of the reference relays is inactive.

As soon as at least one of the reference relays is inactive, the switch-on condition for the reference relay function is considered unfulfilled.

In the NAND mode, the switch-on condition for the reference relay function is considered fulfilled when at least one of the reference relays is inactive.

If none of the reference relays is inactive, the switch-on condition for the reference relay function is considered unfulfilled.



#### Note:

If more than one function block has been activated, relays of numerically higher function blocks may not be used as reference relays.



#### Note:

For more information about timer adjustment, see page 10.

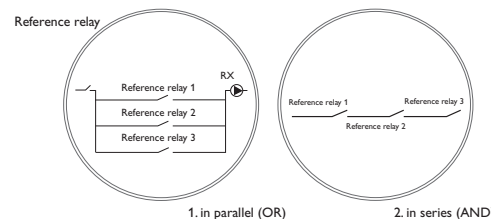
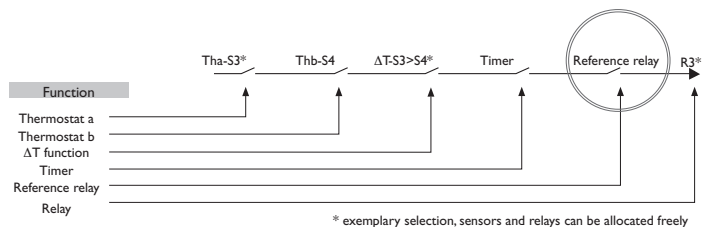

## 10 Heating

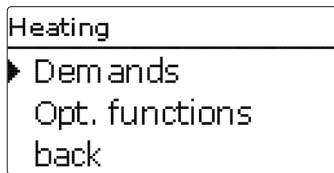

In this menu, all adjustments for the heating part of the arrangement can be made. Demands can be activated and optional functions can be selected and adjusted.

### Heating / Demands

Adjustment channel	Description	Adjustment range/ selection	Factory setting
Dem. 1 (2)	Demand 1 (2)	Activated, Deactivated	Deactivated
Relay	Relay selection	system dependent	-

### 10.1 Demands

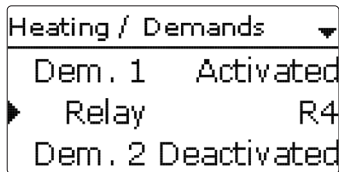

In this menu, up to 2 heating demands can be activated and adjusted.

**Activated demands will be available for selection in the relay allocation channels of the corresponding optional functions. This way, several optional functions can demand the same heat source.**

If, for example the potential-free relay R4 is allocated to **demand 1**, the selection **Dem. 1** will then become available in addition to the free relays in the adjustment channels **Demand** of the optional functions for the heating part of the system. This way, e.g. the DHW heating function can demand the same boiler for afterheating as the thermal disinfection function.

## 10.2 Optional functions

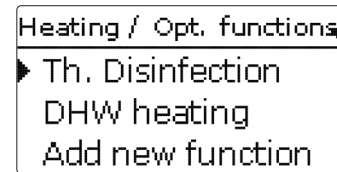

In this menu, optional functions can be selected and adjusted for the heating part of the arrangement.

By selecting **Add new function**, different pre-programmed functions can be selected. The optional functions are available as long as free relays are available.

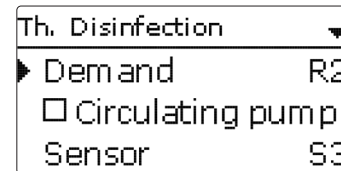

When a function is selected, a sub-menu opens in which all adjustments required can be made.

With this sub-menu, a relay and, if necessary, certain system components can be allocated to the function.

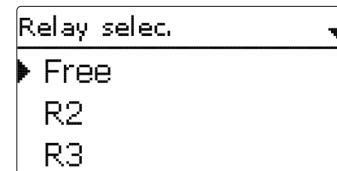

The menu items **Demand** and **Relay** for the relay selection are available in all optional heating functions. Therefore, they will not be explained in the individual function descriptions.

With these menu items, relays can be allocated to the selected functions. All free relays are available for selection.

If **Free** is selected, the function will run normally in the software but will not operate a relay.

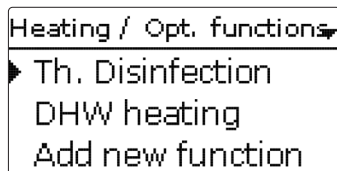

When a function has been adjusted and saved, it will appear in the **Opt. functions** menu above the menu item **Add new function**.

This allows an easy overview of functions already saved.

An overview about which sensor has been allocated to which component and which relay has been allocated to which function is given in the **Status/Service** menu.

At the end of each optional function sub-menu, the menu items **Function** and **Save function** are available.

In order to save a function, select **Save function** and confirm the security enquiry by selecting **Yes**. In functions already saved, the menu item **Delete function** appears instead.

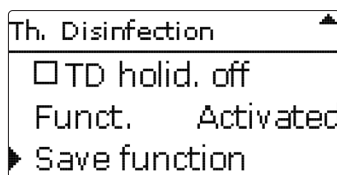

In order to delete a function already saved, select **Delete function** and confirm the security enquiry by selecting **Yes**.

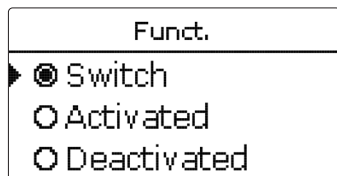

With the menu item **Function**, an optional function already saved can be temporarily deactivated or re-activated respectively. In this case, all adjustments will remain stored, the allocated relays remain occupied and cannot be allocated to another function.

By selecting **Switch**, the function can be activated or deactivated respectively by means of an external switch.

If **Switch** is selected, the channel **Sensor** will appear. In this channel, the sensor input to which the switch is to be connected can be allocated to the function.

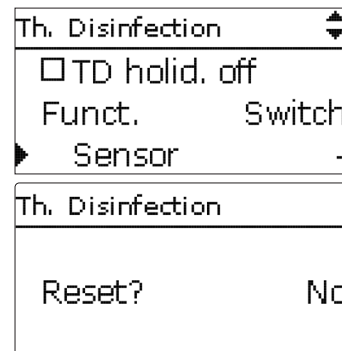

If the menu item **Delete function** is confirmed by pressing the right button (✓), a security enquiry appears. The setting can be changed between **Yes** and **No** by turning the Lightwheel®. If **Yes** has been selected and confirmed by pressing the right button (✓), the function is deleted and available under **Add new function** again. The corresponding relays are available again.

## Thermal disinfection

Th. Disinfection

- ▶ Demand Dem.1
- Circulating pump
- Sensor S3

### Heating/Opt. functions/Add new function/Th. disinfection

Adjustment channel	Description	Adjustment range/selection	Factory setting
Demand	Demand relay selection	system dependent	system dependent
Circulating pump	Circulating pump option	Yes, No	No
Relay	Circulating pump relay selection	system dependent	system dependent
Sensor	Disinfection sensor selection	system dependent	system dependent
Interval	Monitoring period	0 ... 30, 1 ... 23 (dd:hh)	1d 0h
Temperature	Disinfection temperature	45 ... 90 °C	60 °C
Duration	Disinfection period	0.5 ... 24.0 h	1.0 h
Starting time	Starting delay option	Yes, No	No
Starting time	Starting time	00:00 ... 23:30	20:00
Hyst. off	Switch-off hysteresis	2 ... 20K	5K
Hyst. on	Switch-on hysteresis	1 ... 19K	2K
TD hold. off	Thermal disinfection off when holiday function is active	Yes, No	No
Funct.	Activation/ Deactivation	Activated, Deactivated, Switch	Activated
Sensor	Sensor input allocation	-	-
Save/ Delete function	Save/ Delete function	-	-

This function helps to contain the spread of Legionella in DHW stores by systematically activating the afterheating. One sensor and one relay can be selected for this function. For thermal disinfection, the temperature at the allocated sensor has to be monitored.

The monitoring period starts as soon as the temperature at the allocated sensor falls below the disinfection temperature. When the monitoring period ends, the allocated reference relay activates the afterheating. The disinfection period starts, if the temperature at the allocated sensor exceeds the disinfection temperature. Thermal disinfection can only be completed when the disinfection temperature is exceeded for the duration of the disinfection period without any interruption.

## Starting time delay

Th. Disinfection

- ▶  Start. time
- Start. time 20:00
- Hyst. off 5 K

If the starting delay option is activated, a starting time for the thermal disinfection with starting delay can be adjusted. The activation of the afterheating is then delayed until that starting time after the monitoring period has ended. If the monitoring period ends, for example, at 12:00 o'clock, and the starting time has been set to 18:00, the reference relay will be energised with a delay of 6 hours at 18:00 instead of 12:00 o'clock.

If the **TD hold. off** option is activated, the Thermal disinfection function will remain inactive while the holiday function is active.



### Note:

The parameter **Days of absence** can be accessed via the microbutton  only (see page 11).

## DHW heating

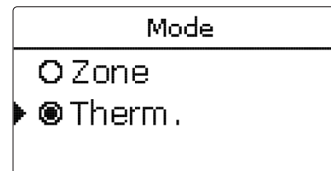
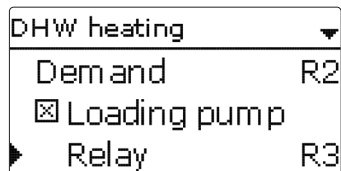

### Heating/Opt. functions/Add new function/DHW heating

Adjustment channel	Description	Adjustment range/ selection	Factory setting
Demand	Demand relay selection	system dependent	system dependent
Loading pump	Loading pump option	Yes, No	No
Relay	Loading pump relay selection	system dependent	system dependent
Overrun time	Overrun option	Yes, No	No
Duration	Overrun time	1 ... 10 min	1 min
Mode	Operating mode	Zone, Therm.	Therm.
Sensor 1	Allocation Sensor 1	system dependent	system dependent
Sensor 2	Allocation Sensor 2 (only if Mode = Zone)	system dependent	system dependent
Ton	Switch-on temperature	0 ... 94 °C	40 °C
Toff	Switch-off temperature	1 ... 95 °C	45 °C
Timer	Timer option	Yes, No	No
DHW holid. off	DHW heating off when holiday function is active	Yes, No	No
Funct.	Activation / Deactivation	Activated, Deactivated, Switch	Activated
Sensor	Sensor input allocation	-	-
Save / Delete function	Save / Delete function	-	-

The **DHW heating** is used for demanding an afterheating for heating the DHW store.

If the **Loading pump** option is activated, the adjustment channel **Relay** appears, in which a relay can be allocated to the loading pump. The allocated relay is switched on and off with the demand relay.

If the **Overrun time** option is activated, the adjustment channel **Duration** appears, in which the overrun time can be adjusted. If the overrun time option is activated, the loading pump relay remains switched on for the adjusted Duration after the demand relay has been switched off.

For the DHW heating, 2 different modes are available:

#### Thermal mode

The allocated demand relay is switched on when the temperature at the allocated **Sensor 1** falls below the adjusted switch-on temperature. If the temperature at the allocated sensor 1 exceeds the adjusted switch-off temperature, the relay is switched off.

#### Zone mode

If the Zone mode has been selected, another sensor can be allocated in the channel **Sensor 2**. The switch-on, or the switch-off conditions respectively, then have to be fulfilled at both sensors in order for the relay to be switched on or off.

When the **Timer** option is activated, a timer is indicated in which time frames for the function can be adjusted.



#### Note:

For more information about timer adjustment, see page 13.

When the **DHW holid. off** option is activated, the DHW heating function will remain inactive while the holiday function is active.



#### Note:

The parameter **Days of absence** can be accessed via the microbutton  only (see page 11).



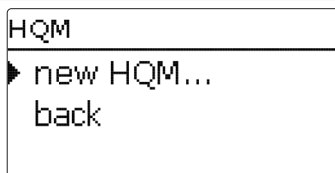

### HQM/new HQM...

Adjustment channel	Description	Adjustment range/ selection	Factory setting
Flow sen.	Flow sensor selection	system dependent	system dependent
Return sen.	Return sensor selection	system dependent	system dependent
Flow rate sen.	Flow rate sensor option	Yes, No	No
Flow rate sen.	Flow rate sensor selection	S5, S6, S7	-
Flow r...	Flow rate (only if Flow rate sen. = No)	1.0 ... 500.0 l/min	3.0 l/min
Relay	Relay selection	system dependent	-
Fluid type	Heat transfer fluid	Tyfocon LS, Propylene glycol, Ethylene glycol, Water	Water
Ratio	Glycol ratio in the heat transfer fluid (only if Fluid type = Propylene glycol or Ethylene glycol)	20 ... 70%	40%
Alternative unit	Alternative unit option	Yes, No	No
Unit	Alternative display unit	Coal, Gas, Oil, CO <sub>2</sub>	CO <sub>2</sub>
Factor	Conversion factor	0.0000001 ... 100.0000000	0,5000000
Funct.	Activation/Deactivation	Activated, Deactivated, Switch	Activated
Sensor	Sensor input allocation	-	-
Save/Delete function	Save/Delete function	-	-

In the **HQM** menu, up to 2 internal heat quantity measurements can be activated and adjusted.

By selecting the menu item **new HQM...**, a new heat quantity measurement can be activated.

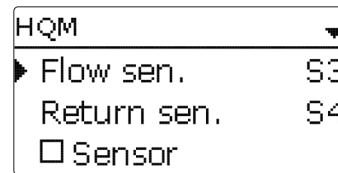

A submenu opens in which all adjustments required for the heat quantity measurement can be made.

If the **Flow rate sensor** option is activated, the impulse input or, if available, a Grundfos Direct Sensor™ or flow rate sensor with frequency signal can be selected. The flow rate sensor with frequency signal and the Grundfos Direct Sensors™ are only available if they have been previously registered in the In-/Outputs menu. The impulse rate must be adjusted in that menu as well.

#### Flow rate sensor inputs:

- V40 = S5/V40
- Grundfos Direct Sensor™ = S6
- Flow rate sensor with frequency signal = S7

If the Flow rate sensor option has been activated and a relay allocated, heat quantity measurement will only take place when the allocated relay is switched on.

If the Flow rate sensor option is deactivated, the controller calculates the heat quantity by means of a fixed flow rate value (heat quantity balancing). The heat quantity balancing (estimation) uses the difference between the flow and return temperatures and the entered flow rate (at 100% pump speed).

➔ Read the flow rate (l/min) and adjust it in the channel **Flow rate**.

➔ Adjust the antifreeze type and concentration of the heat transfer fluid in the channels **Fluid type** and **Ratio**.

When the **Alternative unit** option is activated, the controller will convert the heat quantity into the quantity of fossil fuels (coal, oil or gas) saved, or the CO<sub>2</sub> emission saved respectively. The alternative **Unit** can be selected. A conversion **Factor** must be adjusted for the calculation. The conversion factor depends on the arrangement in use and has to be determined individually.



#### Note:

In 2-store systems, the heat quantity of both stores can be measured with one flowmeter.

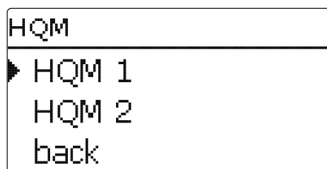

Heat quantity measurements already saved will appear in the HQM menu above the menu item **new HQM...** in numerical order.

If a heat quantity measurement already saved is selected, the above mentioned submenu with all adjustment values will re-open.

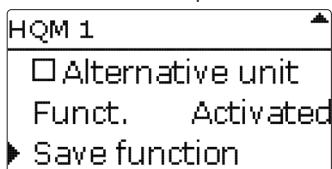

At the end of each HQM submenu, the menu items **Function** and **Save function** are available.

In order to save a heat quantity measurement, select **Save function** and confirm the security enquiry by selecting **Yes**. In heat quantity measurements already saved, the menu item **Delete function** will appear instead.

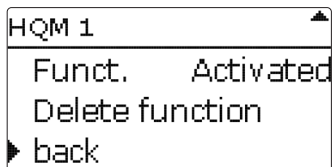

In order to delete a heat quantity measurement already saved, select **Delete function** and confirm the security enquiry by selecting **Yes**. The heat quantity measurement deleted will disappear from the list and become available for selection in the **new HQM...** menu again.

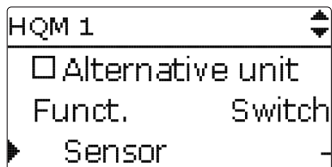

With the menu item **Function**, a heat quantity measurement already saved can be temporarily deactivated or re-activated respectively. In this case, all adjustments will remain stored.

With the selection **Switch**, the heat quantity measurement can be activated or deactivated respectively by means of an external switch.

If **Switch** is selected, the channel **Sensor** will appear. In this channel, the sensor input to which the switch is to be connected can be allocated to the function.

## 12 Basic settings

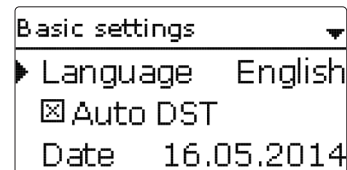

In the **Basic settings** menu, all basic parameters for the controller can be adjusted. Normally, these settings have been made during commissioning. They can be subsequently changed in this menu.

### Basic settings

Adjustment channel	Description	Adjustment range / selection	Factory setting
Language	Selection of the menu language	Deutsch, English, Français, Español, Italiano, Netherlands, Türkçe, České, Polski, Portugues, Hrvatski, Română, Български, Русский, Suomi, Svenska, Magyar	Deutsch
Auto DST	Daylight savings time selection	Yes, No	Yes
Date	Adjustment of the current date	01.01.2001 ... 31.12.2099	01.01.2012
Time	Adjustment of the current time	00:00 ... 23:59	-
Temp. unit	Temperature unit	°C, °F	°C
Vol. unit	Volume unit	Gallons, Litre	Litre
Press. unit	Pressure unit	psi, bar	bar
Energy unit	Energy unit	kWh, MBTU	kWh
Factory setting	back to factory settings	Yes, No	No
Scheme	Selection of pre-programmed system schemes	0000 ... 9999	-

## 13 MicroSD card

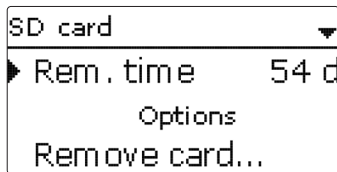

### SD card

Adjustment channel	Description	Adjustment range/selection	Factory setting
Rem. time	Remaining logging time	-	-
Remove card...	Safely remove card	-	-
Save adj.	Save adjustments	-	-
Load adj.	Load adjustments	-	-
Logging interval	Data logging interval	00:01 ... 20:00 (mm:ss)	01:00
Logging type	Logging type	Cyclic, Linear	Linear
Format card	Start formatting memory card	-	-

The controller is equipped with a MicroSD card slot for MicroSD memory cards.

With a MicroSD card, the following functions can be carried out:

- Logging measurement and balance values. After the transfer to a computer, the values can be opened and visualised, e. g. in a spreadsheet.
- Store adjustments and parameterisations on the MicroSD card and, if necessary, retrieve them from there.
- Running firmware updates on the controller.

### Firmware updates

The current software can be downloaded from [www.resol.com/firmware](http://www.resol.com/firmware). When a MicroSD card with a firmware update is inserted, the enquiry **Update?** is indicated on the display.

➔ In order to run an update, select **Yes** and confirm with the right button (✓).

The update is run automatically. The indication **Please wait** and a progress bar appear on the display. When the update has been completed, the controller will automatically reboot and run a short initialisation phase.



#### Note:

Only remove the card when the initialisation phase has been completed and the main menu is indicated on the controller display!

➔ To skip the update, select **No**.

The controller commences normal operation.



#### Note:

The controller will only recognise a firmware update file if it is stored in a folder named **RESOL\SLT** on the first level of the MicroSD card.

➔ Create a folder named **RESOL\SLT** on the MicroSD card and extract the downloaded ZIP file into this folder.

### Starting the logging

1. Insert the MicroSD card into the slot.
2. Adjust the desired logging type and interval.

Logging will start immediately.

### Completing the logging process

1. Select the menu item **Remove card...**
2. After **Remove card** is displayed, remove the card from the slot.

When **Linear** is adjusted in the logging type adjustment channel, data logging will stop if the capacity limit is reached. The message **Card full** will be displayed.

If **Cyclic** is adjusted, the oldest data logged onto the MicroSD card will be overwritten as soon as the capacity limit is reached.



#### Note:

Because of the increasing size of the data packets, the remaining logging time does not decrease linearly. The data packet size can increase, e. g. with the increasing operating hours value.

### Storing controller adjustments

➔ To store the controller adjustments on a MicroSD card, select the menu item **Save adjustments**.

While the adjustments are being stored, first **Please wait**, then **Done!** will be indicated on the display. The controller adjustments are stored as a .SET file on the MicroSD card.

### Loading controller adjustments

1. To load controller adjustments from a MicroSD card, select the menu item **Load adjustments**.

The File selection window is indicated.

2. Select the desired .SET file.

While the adjustments are being loaded, first **Please wait**, then **Done!** will be indicated on the display.



**Note:**

To safely remove the MicroSD card, always select the menu item **Remove card...** before removing the card.

## 14 Manual mode

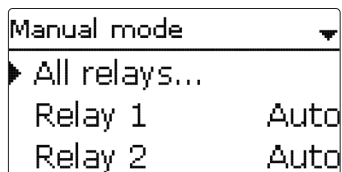

### Manual mode

Adjustment channel	Description	Adjustment range/selection	Factory setting
Relay 1...X	Operating mode selection	On, Max, Auto, Min, Off	Auto
All relays...	Operating mode of all relays	Auto, Off	Auto

In the **Manual mode** menu, the operating mode of the relays can be adjusted.

In the menu item **All relays...**, all relays can be switched off (Off) or set to automatic mode (Auto) at once:

Off = Relay is switched off (manual mode)

Auto = Relay is in automatic mode

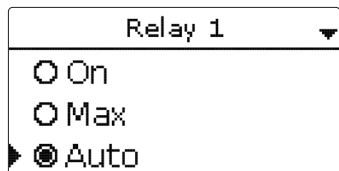

The operating mode can be selected for each individual relay, too. The following options are available:

On = Relay active at 100% speed (manual mode)

Off = Relay is switched off (manual mode)

Min = Relay active with minimum speed (manual mode)

Max = Relay active with maximum speed (manual mode)

Auto = Relay is in automatic mode



**Note:**

After service and maintenance work, the relay mode must be set back to **Auto**. Normal operation is not possible in manual mode.

## 15 User code

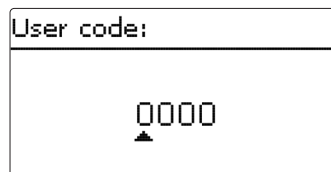

The access to some adjustment values can be restricted via a user code (customer).

1. Installer **0262** (Factory setting)

All menus and adjustment values are shown and all values can be altered.

2. Customer **0000**

The installer level is not shown, adjustment values can be changed partly.

For safety reasons, the user code should generally be set to the customer code before the controller is handed to the customer!

➔ In order to restrict the access, enter 0000 in the menu item **User code**.

## 16 In-/Outputs

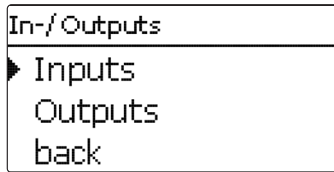

In the **In-/Outputs** menu, sensor offsets can be adjusted and relay outputs can be configured.

### 16.1 Inputs

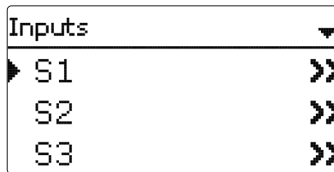

In this sub-menu, the type of the sensor connected can be adjusted for each individual input. The following types can be selected:

- S1 ... S4 : Switch, KTY, Pt500, Pt1000, None
- S5 : Switch, KTY, Pt500, Pt1000, Impulse, None
- S6 : VFS, RPS, None
- S7 : DN20, DN25, DN32, None

#### ATTENTION! System damage!



Selecting the wrong sensor type will lead to unwanted controller actions. In the worst case, system damage can occur!

→ **Make sure that the right sensor type is selected!**

If VFS, RPS, KTY, Pt500 or Pt1000 are selected, the channel **Offset** appears, in which an individual offset can be adjusted for each sensor.

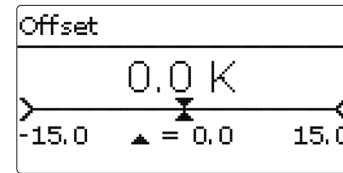

#### Note:

When a Grundfos Direct Sensor™ is used, it will appear as S6 in the sensor selection of all functions.



#### Note:

When a Grundfos Direct Sensor™ is used, the sensor ground common terminal block must be connected to PE (see page 8).

### In-/Outputs/Inputs

Adjustment channel	Description	Adjustment range/selection	Factory setting
S1 ... S7	Sensor input selection	-	-
Type	Sensor type selection (S1 ... S4)	Switch, KTY, Pt500, Pt1000, None	Pt1000
Offset	Sensor offset	-15.0 ... +15.0K	0.0K
S5	Impulse input selection	-	-
Type	Sensor type selection (S5)	Impulse, Switch, KTY, Pt500, Pt1000, None	Impulse
Inverted	Switch inversion (only when Type = Switch)	Yes, No	No
Vol./Imp.	Impulse rate	0.1 ... 100.0	1,0
S6	Grundfos Direct Sensor™ selection		
Type	Grundfos Direct Sensor™ type	RPS, VFS, None	None
Max.	Maximum pressure (if Type = RPS)	0.0 ... 16.0 bar	6 bar
Min.	Minimum flow rate (if Type = VFS)	1 ... 399 l/min	2 l/min
Max.	Maximum flow rate (if Type = VFS)	2 ... 400 l/min	40 l/min
S7	Flow rate sensors with frequency signal selection	-	-
Type	Flow rate sensors with frequency signal nominal width (S7)	DN20, DN25, DN32, None	DN20

## 16.2 Outputs

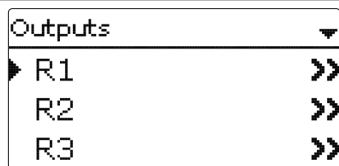

### In-/Outputs/Outputs

Adjustment channel	Description	Adjustment range/ selection	Factory setting
R1 ... R4	Relay output selection	-	-
Signal	Signal type	Adapter, 0-10 V, PWM, Standard	system dependent
Output	PWM output selection	Output A, Output B	-
Profile	PWM characteristic curve	Solar, Heating	Solar
Min. speed	Minimum speed	(20) 30 ... 100%	system dependent
Max. speed	Maximum speed	(20) 30 ... 100%	system dependent

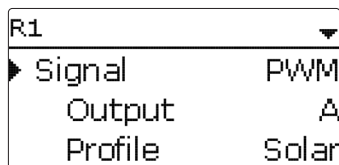

In this menu, the signal type and the minimum speed can be adjusted for each individual relay.

The signal type determines the way speed control of a connected pump is effected. The following modes are available:

Adapter = Speed control signal via a VBus®/PWM interface adapter

0-10V = Speed control via a 0-10V signal

PWM = Speed control via a PWM signal

Standard = Burst control (factory setting)

Speed control of a HE pump is possible via a PWM signal/0-10V control. The pump has to be connected to the relay (power supply) as well as to one of the PWMA/B outputs of the controller.

If **PWM** is selected, the channels **Output** and **Profile** appear. In the Output channel, one of the 2 PWM outputs can be selected. In the Profile channel, PWM characteristic curves for solar and heating pumps can be selected.



#### Note:

If PWM, Adapter or 0-10V is selected for an output, the adjustment range for the corresponding minimum speed will extend to 20 ... 100%.

### Signal characteristic: PWM; Profile: Solar

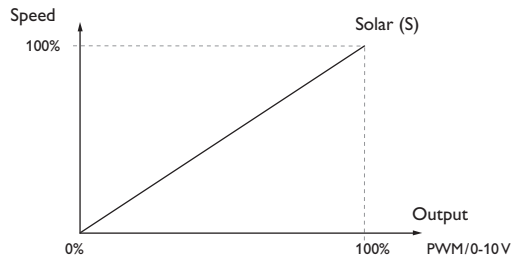

### Signal characteristic: PWM; Profile: Heating

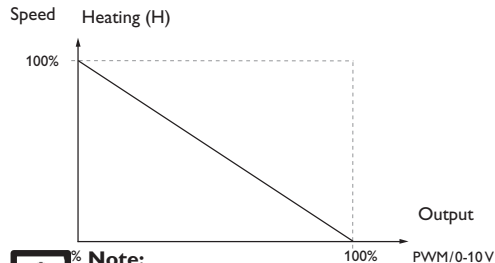

#### Note:

When the minimum pump speed value adjusted in the Outputs menu differs from the minimum pump speed adjusted in an optional function that uses the same output, only the higher value will be come into effect.

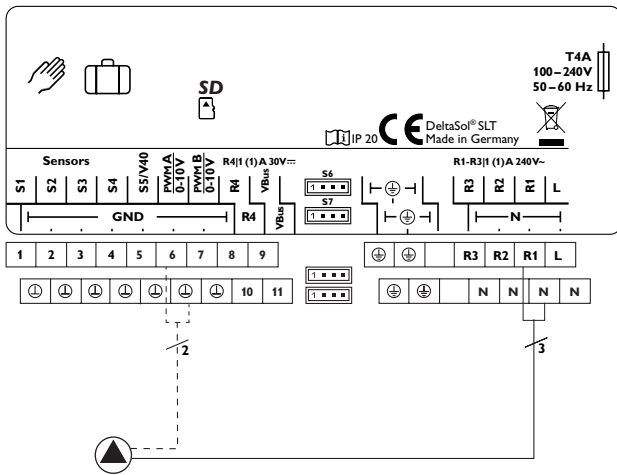

Example of the electrical connection of a high-efficiency pump

## 17 Troubleshooting

If a malfunction occurs, a message will appear on the display of the controller.

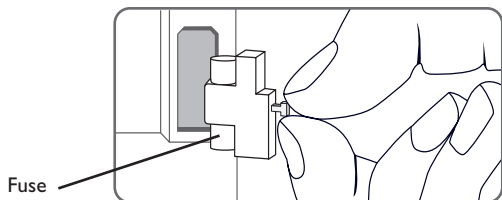

Lightwheel® is flashing red.

Sensor fault. An error code instead of a temperature is shown on the sensor display channel.

Short circuit or line break  
Disconnected temperature sensors can be checked with an ohmmeter. Please check if the resistance values correspond with the table.

°C	°F	Ω Pt500	Ω Pt1000	Ω KTY	°C	°F	Ω Pt500	Ω Pt1000	Ω KTY
-10	14	481	961	1499	55	131	607	1213	2502
-5	23	490	980	1565	60	140	616	1232	2592
0	32	500	1000	1633	65	149	626	1252	2684
5	41	510	1019	1702	70	158	636	1271	2778
10	50	520	1039	1774	75	167	645	1290	2874
15	59	529	1058	1847	80	176	655	1309	2971
20	68	539	1078	1922	85	185	664	1328	3071
25	77	549	1097	2000	90	194	634	1347	3172
30	86	559	1117	2079	95	203	683	1366	3275
35	95	568	1136	2159	100	212	693	1385	3380
40	104	578	1155	2242	105	221	702	1404	3484
45	113	588	1175	2327	110	230	712	1423	3590
50	122	597	1194	2413	115	239	721	1442	3695

### WARNING! Electric shock!



Upon opening the housing, live parts are exposed!

→ Always disconnect the controller from power supply before opening the housing!

The controller is protected by a fuse. The fuse holder (which also holds the spare fuse) becomes accessible when the cover is removed. To replace the fuse, pull the fuse holder from the base.

The display is permanently off.

Press the right button (✓). Display illuminated?

no

yes

Controller has been in standby, everything o.k.

Check the power supply of the controller. Is it disconnected?

no

yes

The fuse of the controller could be blown. The fuse holder (which holds the spare fuse) becomes accessible when the cover is removed. The fuse can then be replaced.

Check the supply line and reconnect it.



### Note

For answers to frequently asked questions (FAQ) see [www.resol.com](http://www.resol.com).



Pump is overheated, but no heat transfer from the collector to the store, flow and return have the same temperature; perhaps also bubbling in the lines.

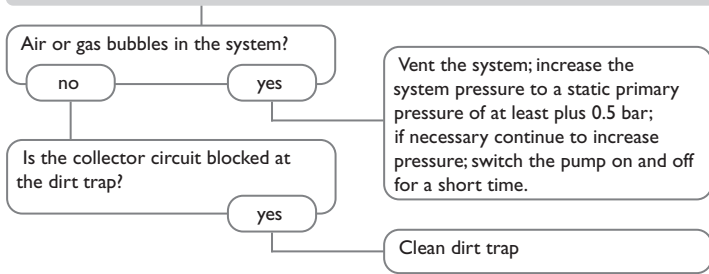

Pump starts up very late.

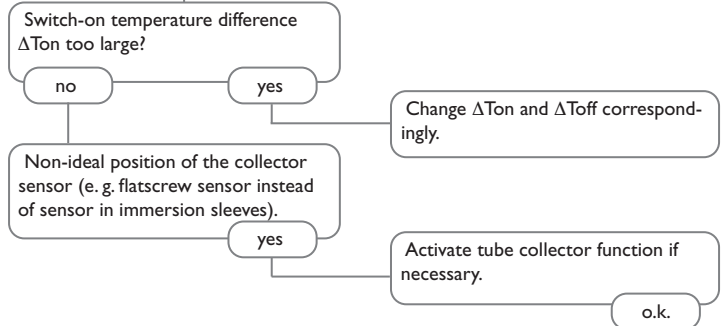

Pump starts for a short moment, switches off, switches on again, etc.

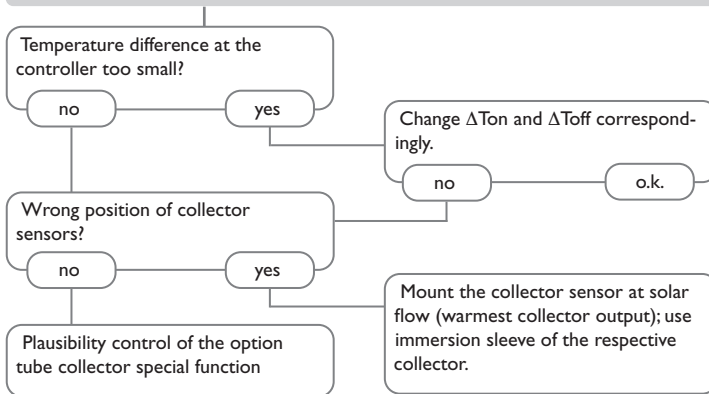

The temperature difference between store and collector increases enormously during operation; the collector circuit cannot dissipate the heat.

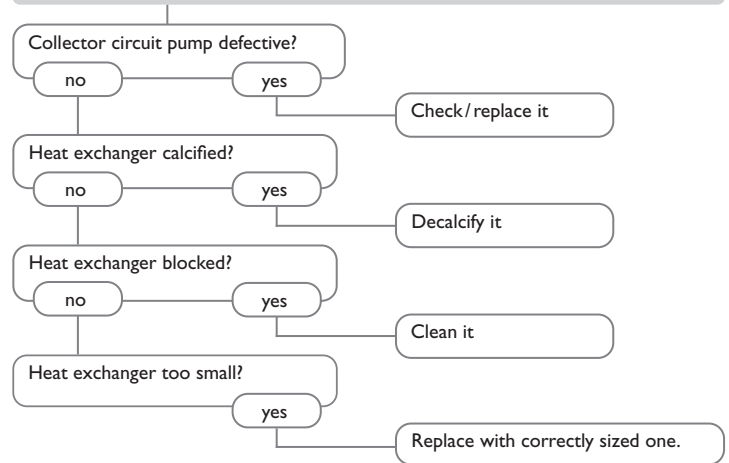

The solar circuit pump does not work, although the collector is considerably warmer than the store.

Display illuminated?  
If not, press the right button (✓). Display illuminated again?

yes no

There is no current; check fuses / replace them and check power supply.

Does the pump start up in manual operation?

no yes

The adjusted temperature difference for starting the pump is too high; choose a value which makes more sense.

Is the pump current enabled by the controller?

no yes

Is the pump stuck?

yes

Controller might be defective - replace it.

Turn the pump shaft using a screwdriver; now passable?

no

Pump is defective - replace it.

Stores cool down at night.

Collector circuit pump runs during the night?

no yes

Check controller

Collector temperature at night is higher than the outdoor temperature.

no yes

Check the non-return valves in the flow and the return pipe for functional efficiency.

Sufficient store insulation?

yes no

Increase insulation.

a

a

Insulation close enough to the store?

yes no

Replace insulation or increase it.

Are the store connections insulated?

yes no

Insulate the connections.

Warm water outflow upwards?

no yes

Change connection and let the water flow sideways or through a siphon (downwards); less store losses now?

no yes

o.k.

Does the DHW circulation run for a very long time?

no yes

Use the circulation pump with timer and switch-off thermostat (energy-efficient circulation).

Circulation pump and blocking valve should be switched off for 1 night; less store losses?

yes no

Check whether the pumps of the after-heating circuit run at night; check whether the non-return valve is defective; problem solved?

no

Check the non-return valve in warm water circulation - o.k.

yes no

Further pumps which are connected to the solar store must also be checked.

Clean or replace it.

The gravitation circulation in the circulation line is too strong; insert a stronger valve in the non-return valve or an electrical 2-port valve behind the circulation pump; the 2-port valve is open when the pump is activated, otherwise it is closed; connect pump and 2-port valve electrically in parallel; activate the circulation again. Deactivate pump speed control!



### DL3 Datalogger

For visualisation via VBus.net, incl. SD card, mains adapter, network and VBus® cable.



### DL2 Datalogger

For visualisation via VBus.net, incl. SD card and network cable, mains adapter and VBus® cable pre-connected.



### KM2 Communication module

For visualisation via VBus.net, incl. service CD, network cable and mains adapter, VBus® cable pre-connected



### SD3 / SDFK Smart Display / GA3 Large Display

The SD3 Smart Display is used for visualising data issued by the controller: collector temperature, store temperature and energy yield of the solar thermal system.

The SDFK Smart Display indicates the solid fuel boiler temperature and the bottom/top store temperatures as well as the pump status.

The GA3 is a completely mounted large display module for visualisation of collector- and store temperatures as well as the heat quantity yield of the solar system.



### VFS/RPS Grundfos Direct Sensors™

Analogue sensors in different versions



### V40 Flowmeter

The V40 is a measuring instrument for detecting the flow of water or water/glycol mixtures.



### AM1 Alarm module

Alarm module for signalling system failures



### VBUS®/USB, VBUS®/LAN, VBUS®/Modbus and VBUS®/BACnet interface adapters

With the VBUS®/USB interface adapter, the controller can be connected to the USB port of a PC via the VBUS®.

The VBUS®/LAN interface adapter is designed for the direct connection of the controller to a PC or router. It enables easy access to the controller via the local network of the owner.

The VBUS®/Modbus interface adapter is designed for the connection of the controller to a local network for communication via Modbus TCP/IP.

The VBUS®/BACnet interface adapter is designed for the connection of the controller to a local network for communication via BACnet/IP.



### SP10 Overvoltage protection device

Overvoltage protection device, suitable for mounting outdoors.



### Sensors

The product range includes high-precision platinum temperature sensors, flatscrew sensors, outdoor temperature sensors, indoor temperature sensors, cylindrical clip-on sensors, also as complete sensors with immersion sleeve

### VBus.net

The Internet portal for easy and secure access to your system data.

VBus.net is all about the data of your controller. Live data of your system, customized filter settings and much more await you.

<b>A</b>	
Afterheating suppression.....	35
Antifreeze, solar optional function.....	35
<b>B</b>	
Balance values .....	24
Bypass, solar optional function.....	32
<b>C</b>	
Circulation .....	49
Collector cooling, Cooling mode.....	37
Collector emergency temperature.....	28
Commissioning menu.....	17
Control lamp.....	11
Cooling mode.....	36
<b>D</b>	
Data communication / Bus.....	9
Data logging.....	59
DHW heating.....	56
Drainback option.....	37
<b>E</b>	
Electrical connection.....	8
Error messages.....	25
Error messages, acknowledgement of.....	25
Error relay.....	47
<b>F</b>	
Flow rate monitoring.....	40
Function block.....	51
Fuse, replacing of.....	64
<b>H</b>	
Heat dump.....	39
Heat exchange.....	48
Heating demands.....	53
Heat quantity measurement.....	57
HE pump .....	8
Holiday.....	11
<b>L</b>	
Lightwheel®.....	11
Loading controller adjustments.....	59
<b>M</b>	
Manual mode.....	11, 60
Maximum store temperature.....	29
Meas. values.....	24
Microbuttons.....	11
MicroSD .....	9
Minimum collector limitation.....	28
Mixer, optional arrangement function.....	46
Mounting.....	6
<b>O</b>	
Operating hours counter.....	24
Operating mode, relays.....	60
Overpressure.....	41
<b>P</b>	
Parallel relay, optional arrangement function.....	46
Parallel relay, solar optional function.....	36
Priority logic.....	29
PWM pump speed control.....	62
<b>R</b>	
Return preheating.....	50
<b>S</b>	
Solid fuel boiler.....	49
Store cooling, Cooling mode.....	37
Store set temperature.....	29
Storing controller adjustments.....	59
System cooling, Cooling mode.....	42
<b>T</b>	
Target temperature, solar optional function.....	34
Technical data.....	5
Thermal disinfection.....	55
Thermostat function.....	52
Tube collector function.....	34
Twin pump .....	38
<b>U</b>	
User code.....	60
<b>Z</b>	
Zone loading.....	47







Distributed by:

**RESOL – Elektronische Regelungen GmbH**

Heiskampstraße 10  
45527 Hattingen / Germany

Tel.: +49 (0) 23 24 / 96 48 - 0

Fax: +49 (0) 23 24 / 96 48 - 755

[www.resol.com](http://www.resol.com)

[info@resol.com](mailto:info@resol.com)

**Important note**

The texts and drawings in this manual are correct to the best of our knowledge. As faults can never be excluded, please note:

Your own calculations and plans, under consideration of the current standards and directions should only be basis for your projects. We do not offer a guarantee for the completeness of the drawings and texts of this manual - they only represent some examples. They can only be used at your own risk. No liability is assumed for incorrect, incomplete or false information and / or the resulting damages.

**Note**

The design and the specifications can be changed without notice.

The illustrations may differ from the original product.

**Imprint**

This mounting and operation manual including all parts is copyrighted. Any other use outside the copyright requires the approval of **RESOL – Elektronische Regelungen GmbH**. This especially applies for copies, translations, micro films and the storage into electronic systems.

© **RESOL – Elektronische Regelungen GmbH**