

RESOL DeltaSol[®] BS/4

Mounting

Connection

Application examples

Operation

Troubleshooting



DeltaSol[®] BS/4



48005421

**Thank you for buying this RESOL product.
Read this manual carefully to get the best performance from this unit.
Please keep this manual carefully.**

en-US/CA

Manual

www.resol.com

Contents

General	2	2.1 Push buttons.....	14
Overview	3	2.2 System monitoring display	14
1. Installation	4	2.3 Flashing codes	15
1.1 Mounting	4	3. Commissioning	16
1.2 Electrical connection.....	4	4. Channel overview	18
1.3 Data communication/ Bus.....	5	4.1 Display channels	18
1.4 Terminal allocation in the different system layouts	6	4.2 Adjustment channels.....	20
System layout 1.....	6	5. Troubleshooting	27
System layout 2.....	8	5.1 Various	28
System-specific functions.....	10	6. Accessories	30
System layout 3.....	12	Impressum	32
2. Operation and function	14		

General

Safety advice:

Please read the following information carefully before installing and operating the controller. In this way damage to the solar system caused by wrong installation will be avoided. Please make sure that the mounting is adapted to the characteristics of the building, that the local regulations are respected and is conform with the technical rules.

Please pay attention to the following safety advice in order to avoid danger and damage to people and property.

Subject to technical change. Errors excepted.

Instructions:

Attention should be paid to

- Valid national and local standards and regulations
- Respective valid standards and directives

Equipment to be installed and used in accordance with the rules of the National Electrical Code (NEC) or with Canadian Electrical Code (CEC), Part I.

These instructions are exclusively addressed to authorized skilled personnel.

- Only qualified electricians should carry out installation and maintenance work.
- Initial installation should be carried out by qualified personnel

Description of symbols

WARNING!	Warnings are indicated with a warning triangle! They contain information on how to avoid the danger described.

Signal words describe the danger that may occur, when it is not avoided.

Warning means that injury, possibly life-threatening injury, can occur.

Attention means that damage to the appliance can occur.



Note

Notes are indicated with an information symbol.

→ Arrows indicate instruction steps that should be carried out.

Information about the product

Proper usage

The solar controller is designed for use in solar thermal and heating systems in compliance with the technical data specified in these instructions.

Improper use excludes all liability claims.



Note

Strong electromagnetic fields can impair the function of the controller.

→ Make sure the controller as well as the system are not exposed to strong electromagnetic fields.

Overview

- System-monitoring-display
- Up to 4 Pt1000 temperature sensors
- semiconductor relay for pump speed control
- 3 basic system layouts to choose from
- Energy metering
- VBus®
- Function control
- Thermostat function (time controlled)
- Control of the system by ServiceCenter software possible
- User-friendly operation
- Housing with outstanding design
- Extra-low power consumption
- HE pump control via adaptor

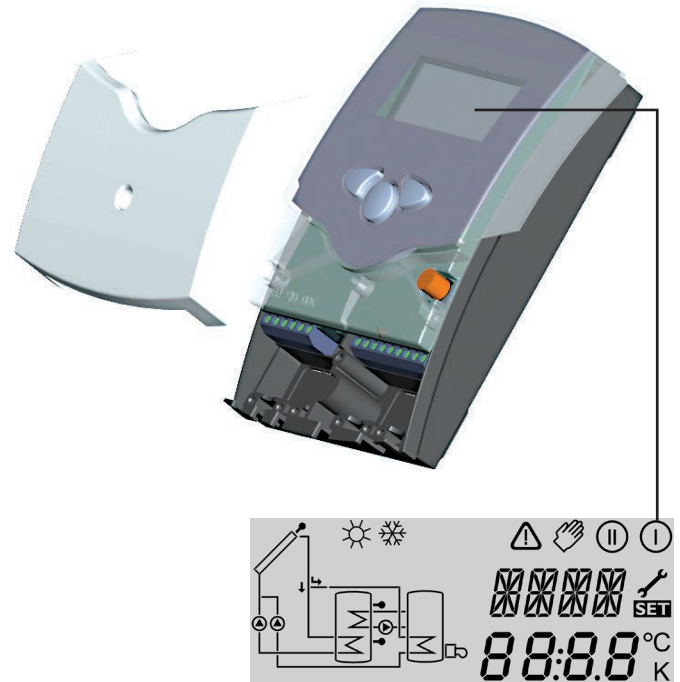

Included with the BS/4:

- 1 × DeltaSol® BS/4
- 1 × accessory bag
 - 1 × spare fuse T4A
 - 2 × screws and wall plugs
 - 4 × strain relief and screws
- 1 × manual

Additionally enclosed in the full kit:

- 1 × sensor FKP6
- 2 × sensor FRP6

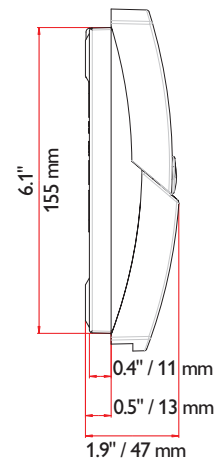
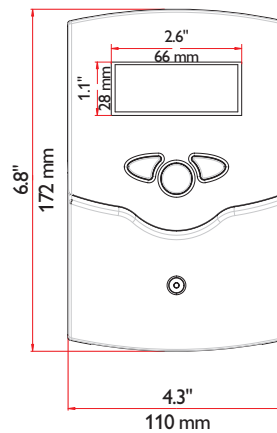

Technical data

Housing: plastic, PC-ABS and PMMA

Protection type: IP 20 / EN 60529

Ambient temp.: 32 ... 104 °F
[0 ... 40 °C]

Size: 6.8" × 4.3" × 1.9"
172 × 110 × 47 mm

Mounting: wall mounting, mounting into patch-panels is possible

Display: System screen for system visualization, 16-segment display, 7-segment display, 8 symbols for system status and operating control lamp

Operation: by 3 push buttons at the front of the housing

Functions: Differential temperature controller with optional add-on system functions. Function control, operating hours counter for solar pump, evacuated tube collector function, pump speed control, thermostat function, drainback and booster option, and energy metering.

Inputs: for 4 Pt1000 temperature sensors

Outputs: 2 semiconductor relays

Bus: VBus®

Power supply: 100 – 240 V~

Standby power consumption: < 1 W

Switching capacities:

R1: 1 (1) A 100 – 240 V~
(semiconductor relay)

R2: 1 (1) A 100 – 240 V~
(semiconductor relay)

1. Installation

1.1 Mounting

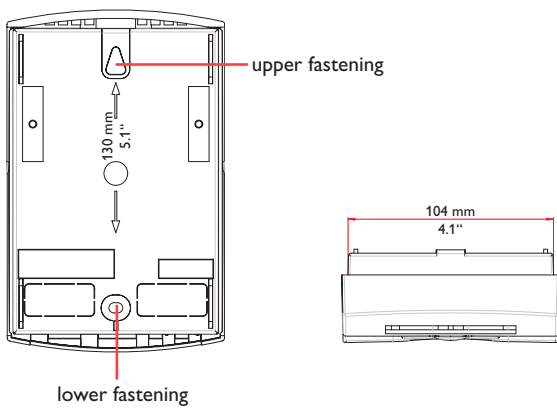
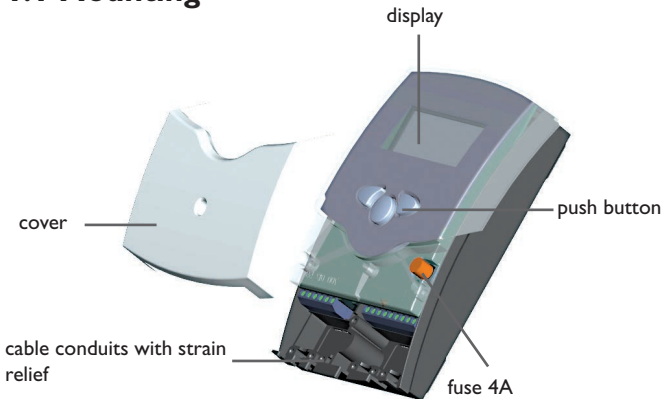

WARNING!	Electric shock!
	Opening the housing will expose live parts!
	→ Switch off power supply and disconnect the device from power supply before opening the housing!

- The unit must only be installed
- in a dry interior location
 - in a non-hazardous location
 - away from electromagnetic fields

The controller must additionally be supplied from a double-pole switch with contact gap of at least 0.12" [3 mm].

Route sensor cables and power supply cables separately.

- Unscrew the cross-head screw from the cover and remove it along with the cover from the housing
- Mark the upper fastening point on the wall and drill
- Fasten the enclosed wall plug and screw leaving the head protruding
- Hang the housing from the upper fastening point and mark the lower fastening point through the hole in the terminal box (centers 5.1" [130 mm])
- Drill and insert the lower wall plug
- Fasten the housing to the wall with lower fastening screw and tighten
- Complete wiring connections in accordance with terminal allocations, see chap. 1.2 "Electrical connection"
- Place the cover back onto the housing
- Fasten the cover by means of the cross-head screw

1.2 Electrical connection

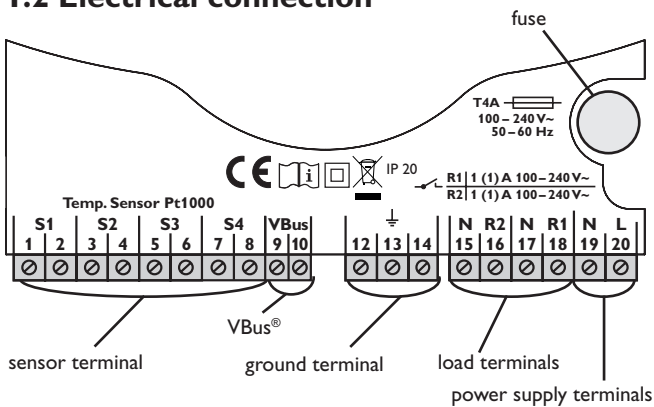

ATTENTION!	ESD damage!
	Electrostatic discharge can lead to damage to electronic components!
	→ Take care to discharge properly before touching the inside of the device. To do so, touch a grounded surface such as a radiator or tap!

Note:
The minimum pump speed must be set to 100 % when auxiliary relays or valves are connected.

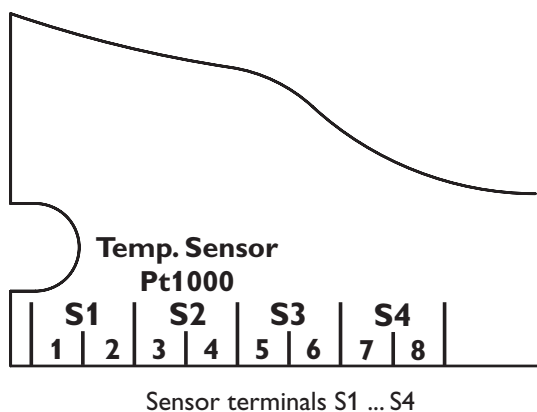
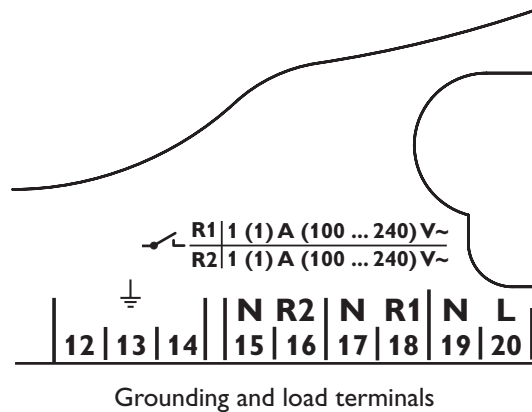

1.3 Data communication/ Bus

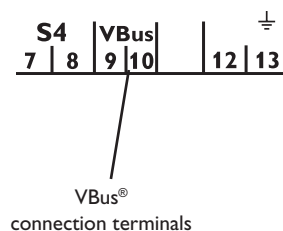

Connecting the device to the power supply must always be the last step of the installation!

The power supply to the controller must be carried out via an external power switch (last step!). The supply voltage must be 100 ... 240 V~ (50 ... 60 Hz). Flexible cables must be attached to the housing with the enclosed strain relief and the corresponding screws.

The controller is equipped with 2 semiconductor relays, to which **loads** such as pumps, valves etc. can be connected:

- Relay 1
 - 18 = conductor R1
 - 17 = neutral conductor N
 - 13 = ground conductor
- Relay 2
 - 16 = conductor R2
 - 15 = neutral conductor N
 - 14 = ground conductor

The **power supply** is to be carried out at the terminals:

- 19 = neutral conductor N
- 20 = conductor L
- 12 = ground terminal

The **temperature sensors** (S1 up to S4) are to be connected to the following terminals with either polarity:

- 1 / 2 = Sensor 1 (e.g. Sensor collector)
- 3 / 4 = Sensor 2 (e.g. Sensor tank)
- 5 / 6 = Sensor 3 (e.g. Sensor tank top)
- 7 / 8 = Sensor 4 (e.g. Sensor return)

All Pt1000 temperature sensors are equipped with a platinum measuring element in their tip. The electrical resistance of the measuring element changes in relation to the temperature (see table in chap. 5).

The difference between **FKP** and **FRP** type sensors only lies in the cable insulation material. The insulation material of FKP type sensor cables resists a higher temperature, so that FKP type sensors should be used as collector sensors. FRP type sensors are best used as reference sensors in tanks or pipes.

The controller is equipped with a RESOL **VBus**® for data transfer with and energy supply to external modules. The connection is carried out at the terminals marked "VBus" (either polarity). One or more RESOL VBus® modules can be connected via this data bus, such as

- GA3 large display, SD3 smart display
- DL2 datalogger
- VBus®/USB or VBus®/LAN interface adaptor
- VBus®/PWM interface adaptor
- AM1 alarm module
- WMZ calorimeter module

By means of a DL2 datalogger or an interface adaptor, the controller can be connected to a PC or a computer network. With the RESOL ServiceCenter Software (RSC) the controller measurements can be read out, processed and visualized. The software allows easy function control of the system. For the remote parametrisation of the controller, a special software tool will be available for download, soon.

1.4 Terminal allocation in the different system layouts

System layout 1

The controller calculates the temperature difference between collector sensor S1 and tank sensor S2. If the difference is larger than or identical to the adjusted switch-on temperature difference (DT O), the solar pump will be operated by relay 1, and the tank will be loaded until the switch-off temperature difference (DT F) or the maximum tank temperature (S MX) is reached.

Sensors S3 and S4 can optionally be connected for measurement purposes. S3 can optionally be used as reference sensor for the tank emergency shutdown option (OSEM). If heat quantity measurement (OHQM) is activated, sensor S4 has to be connected as return sensor. If the drainback option (ODB) is activated, relay 2 can be used to operate a booster pump by activating the booster function (OBST).

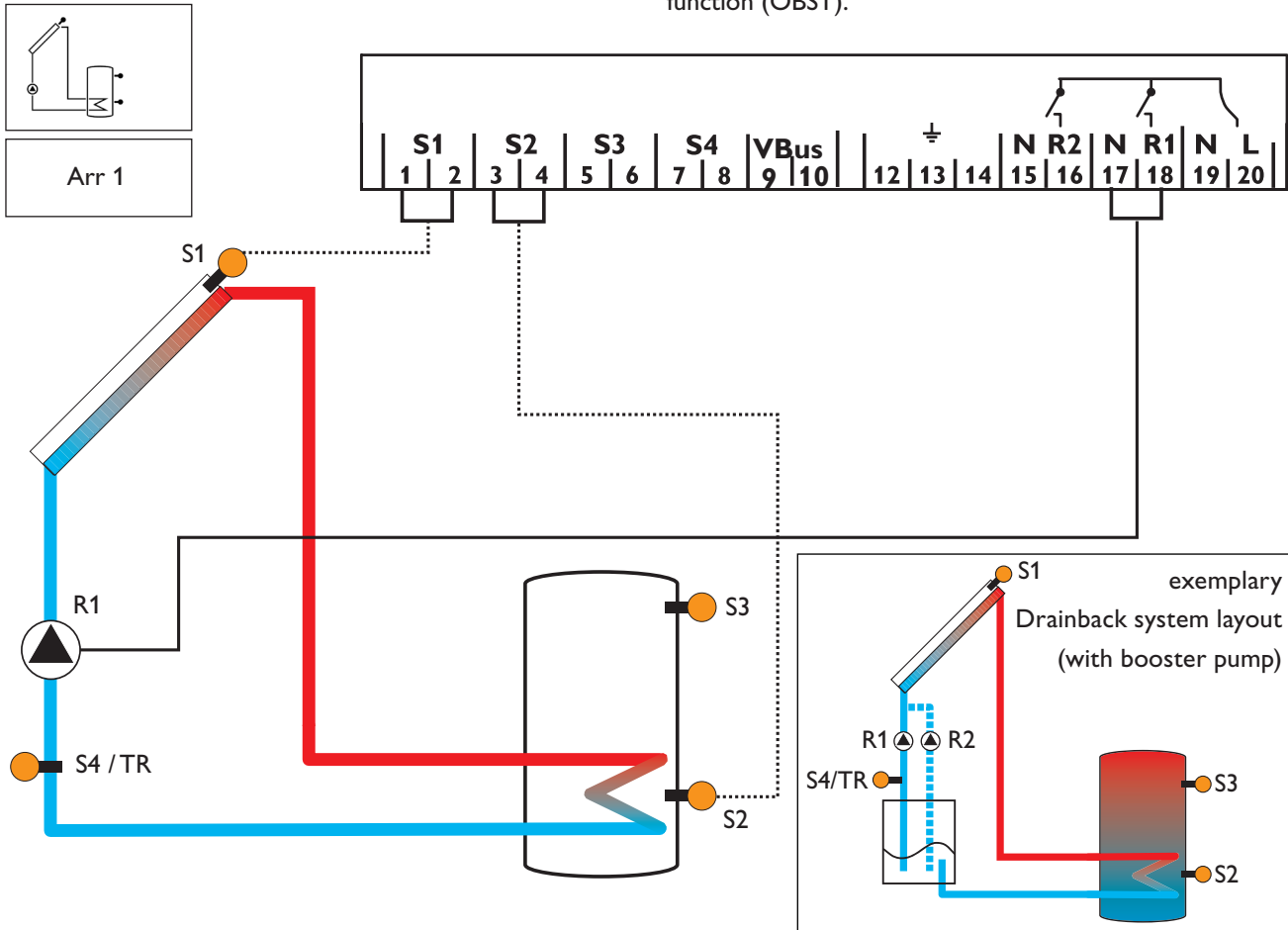

Display Channels				
Channel		Description	Terminal	Page
INIT	x*	ODB initialization active	-	18
FLL	x*	ODB filling time active	-	18
STAB	x*	ODB stabilization in progress	-	18
COL	x	Temperature collector	S1	18
TST	x	Temperature tank	S2	18
S3	x	Temperature sensor 3	S3	18
TSTT	x*	Temperatur tank at the top	S3	18
S4	x	Temperature sensor 4	S4	18
TR	x*	Temperature return sensor	S4	18
n %	x	Pump speed R1	R1	19
hP	x	Operating hours R1	R1	19
hP1	x*	Operating hours R1 (if OBST is activated)	R1	19
hP2	x*	Operating hours R2 (if OBST is activated)	R2	19
kWh	x*	Heat quantity kWh	-	19
MWh	x*	Heat quantity MWh	-	19
TIME	x	Time	-	16

Adjustment Channels				
Channel		Description	Factory setting	Page
Arr	x	System	1	20
DT O	x	Switch-on temperature difference	12.0 °Ra [6.0 K]	20
DT F	x	Switch-off temperature difference	8.0 °Ra [4.0 K]	20
DT S	x	Nominal temperature difference	20.0 °Ra [10.0 K]	20
RIS	x	Rise control R1	4 °Ra [2 K]	20
nMN	x	Minimum pump speed	30 %	20
S MX	x	Maximum tank temperature	140 °F [60 °C]	21
OSEM	x	Option tank emergency shutdown	OFF	21
EM	x	Emergency temperature collector	270 °F [130 °C]	21
		Emergency temperature collector if ODB is activated:	200 °F [95 °C]	21
OCC	x	Option collector cooling	OFF	22
CMX	x*	Maximum collector temperature	230 °F [110 °C]	22
OSYC	x	Option system cooling	OFF	22
DTCO	x*	Cooling switch-on temperature difference	40.0 °Ra [20.0 K]	22
DTCF	x*	Cooling switch-off temperature difference	30.0 °Ra [15.0 K]	22
OSTC	x	Option tank cooling	OFF	23
OHOL	x*	Option holiday cooling	OFF	23
THOL	x*	Holiday cooling temperature	110 °F [40 °C]	23
OCN	x	Option minimum limitation	OFF	23
CMN	x*	Minimum collector temperature	50 °F [10 °C]	23
OCF	x	Option antifreeze	OFF	23
CFR	x*	Antifreeze temperature	40.0 °F [4.0 °C]	23
OTC	x	Option tube collector	OFF	24
TCST	x*	OTC starting time	07:00	24
TCEN	x*	OTC ending time	19:00	24
TCRU	x*	OTC runtime	30 s	24
TCIN	x*	OTC standstill interval	30 min	24
OHQM	x	Option energy metering	OFF	24
FMAX	x*	Maximum flow	6.0 l	24
MEDT	x*	Antifreeze type	1	24
MED%	x*	Antifreeze concentration (only if MEDT = propylene or ethylene)	45 %	24
ODB	x	Drainback option	OFF	25
tDTO	x*	ODB switch-on condition - time period	60 s	25
tFLL	x*	ODB filling time	5.0 min	25
tSTB	x*	ODB stabilization time	2.0 min	25
OBST	s*	Option booster function	OFF	25
MAN1	x	Manual operation R1	Auto	26
MAN2	x	Manual operation R2	Auto	26
ADA1	x	HE pump control	OFF	26
LANG	x	Language	En	26
UNIT	x	Temperature unit	°C	26
RESE	x	Reset - back to factory defaults		26
W0040100		Version number		

Legend:

Symbol	Specification
x	Channel is available
x*	Channel is available if the corresponding option is activated.
s*	System-specific channel, only available if the corresponding option is activated

System layout 2

The controller calculates the temperature difference between collector sensor S1 and tank sensor S2. If the difference is larger than or identical to the adjusted switch-on temperature difference (DT O), the solar pump will be operated by relay 1, and the tank will be loaded until the switch-off temperature difference (DT F) or the maximum tank temperature (S MX) is reached.

Sensor S3 is used for a thermostatic function, which operates relay 2 for afterheating or heat dump purposes, when

the adjusted thermostat switch-on temperature (AH O) is reached. This function can optionally be combined with up to three adjustable time frames.

Sensor S3 can also be optionally used as a reference sensor for the thermal disinfection function OTD or the tank emergency shutdown option (OSEM).

Sensor S4 can optionally be connected for measurement purposes. If heat quantity measurement (OHQM) is activated, sensor S4 has to be connected as return sensor.

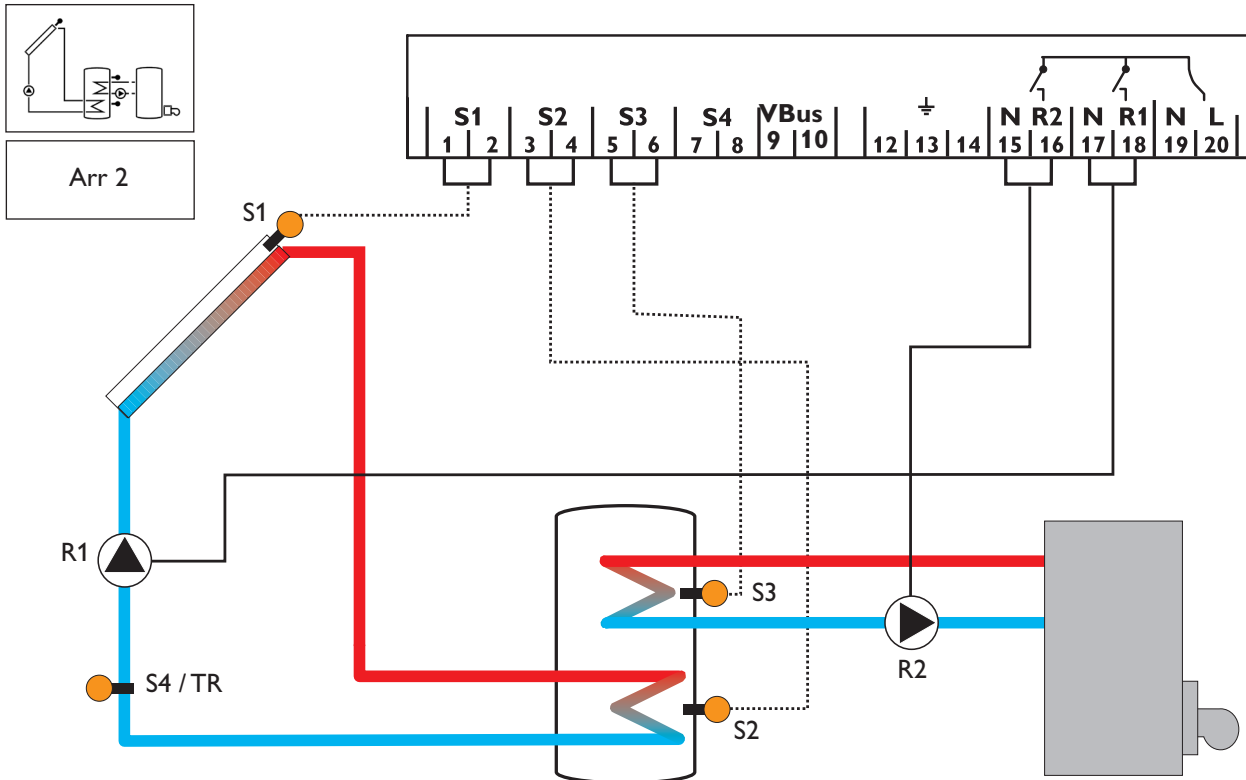

Display Channels				
Channel		Description	Terminal	Page
INIT	x*	ODB initialization active	-	18
FLL	x*	ODB filling time active	-	18
STAB	x*	ODB stabilization in progress	-	18
COL	x	Temperature collector	S1	18
TSTB	x	Temperature tank 1 bottom	S2	18
TSTT	x	Temperature tank 1 at the top	S3	18
TDIS	s*	Thermal disinfection temperature	S3	18
S4	x	Temperature sensor 4	S4	18
TR	x*	Temperature return sensor	S4	18
n1 %	x	Pump speed R1	R1	19
h P1	x	Operating hours R1	R1	19
h P2	x	Operating hours R2	R2	19
kWh	x*	Heat quantity kWh	-	19
MWh	x*	Heat quantity MWh	-	19
CDIS	s*	Countdown of monitoring period	-	19
SDIS	s*	Starting time display	-	19
DDIS	s*	Heating period display	-	19
TIME	x	Time	-	16

Adjustment Channels				
Channel		Description	Factory setting	Page
Arr	x	System	2	20
DT O	x	Switch-on temperature difference	12.0 °Ra [6.0 K]	20
DT F	x	Switch-off temperature difference	8.0 °Ra [4.0 K]	20
DT S	x	Nominal temperature difference	20.0 °Ra [10.0 K]	20
RIS	x	Rise control R1	4 °Ra [2 K]	20
n1MN	x	Minimum pump speed R1	30 %	20
S MX	x	Maximum tank temperature	140 °F [60 °C]	21
OSEM	x	Option tank emergency shutdown	OFF	21
EM	x	Emergency temperature collector	270 °F [130 °C]	21
		Emergency temperature collector if ODB is activated:	200 °F [95 °C]	21
OCC	x	Option collector cooling	OFF	22
CMX	x*	Maximum collector temperature	230 °F [110 °C]	22
OSYC	x	Option system cooling	OFF	22
DTCO	x*	Cooling switch-on temperature difference	40.0 °Ra [20.0 K]	22
DTCF	x*	Cooling switch-off temperature difference	30.0 °Ra [15.0 K]	22
OSTC	x	Option tank cooling	OFF	23
OHOL	x*	Option holiday cooling	OFF	23
THOL	x*	Holiday cooling temperature	110 °F [40 °C]	23
OCN	x	Option minimum limitation	OFF	23
CMN	x*	Minimum collector temperature	50 °F [10 °C]	23
OCF	x	Option antifreeze	OFF	23
CFR	x*	Antifreeze temperature	40.0 °F [4.0 °C]	23
OTC	x	Option tube collector	OFF	24
TCST	x*	OTC starting time	07:00	24
TCEN	x*	OTC ending time	19:00	24
TCRU	x*	OTC runtime	30 s	24
TCIN	x*	OTC standstill interval	30 min	24
OHQM	x	Option energy metering	OFF	24
FMAX	x*	Maximum flow	6.0 l	24
MEDT	x*	Antifreeze type	1	24
MED%	x*	Antifreeze concentration	45 %	24
AH O	s	Switch-on temp. for thermostat 1	110 °F [40 °C]	10
AH F	s	Switch-off temp. for thermostat 1	120 °F [45 °C]	10
t1 O	s	Switch-on time 1 thermostat	00:00	10
t1 F	s	Switch-off time 1 thermostat	00:00	10
t2 O	s	Switch-on time 2 thermostat	00:00	10
t2 F	s	Switch-off time 2 thermostat	00:00	10
t3 O	s	Switch-on time 3 thermostat	00:00	10
t3 F	s	Switch-off time 3 thermostat	00:00	10
ODB	x	Drainback option	OFF	25
tDTO	x*	ODB switch-on condition - time period	60 s	25
tFLL	x*	ODB filling time	5.0 min	25
tSTB	x*	ODB stabilization time	2.0 min	25
OTD	s	Option thermal disinfection	OFF	11
PDIS	s*	Monitoring period	01:00	11
DDIS	s*	Heating period	01:00	11
TDIS	s*	Disinfection temperature	140 °F [60 °C]	11
SDIS	s*	Starting time	00:00	11
MAN1	x	Manual operation R1	Auto	26
MAN2	x	Manual operation R2	Auto	26
ADA1	x	HE pump control	OFF	26
LANG	x	Language	En	26
UNIT	x	Temperature unit	°C	26
RESE	x	Reset - back to factory defaults		26
W0040100		Version number		

Legend:

Symbol	Specification
x	Channel is available
x*	Channel is available if the corresponding option is activated.
s	Channel is specifically available in this system layout
s*	System-specific channel, only available if the corresponding option is activated

System-specific functions

The following functions are exclusively available in system layout 2. The corresponding channels will not be available in any other system layout.

Thermostat function

Backup heating

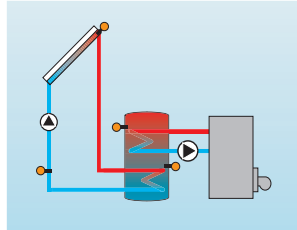

The thermostat function works independently from the solar operation and can be used for using surplus energy or for backup heating.

- **AH O < AH F**
thermostat function for backup heating
- **AH O > AH F**
thermostat function for using surplus energy

Use of surplus energy

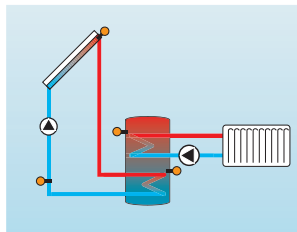

The symbol Ⓜ will be shown on the display if the second relay output is activated.

Reference sensor for the thermostat function is S3!

AH O:

Thermostat switch-on temp.
Adjustment range:
30.0... 200.0 °F
[0.0 ... 95.0 °C]
in steps of 1.0 °F [0.5 °C]
Factory setting:
110.0°F [40.0 °C]



AH F:

Thermostat switch-off temp.
Adjustment range:
30.0... 200.0 °F
[0.0 ... 95.0 °C]
in steps of 1.0 °F [0.5 °C]
Factory setting:
120.0 °F [45.0 °C]



t1 O, t2 O, t3 O:

Thermostat switch-on time
Adjustment range:
00:00...23:45
Factory setting: 00:00

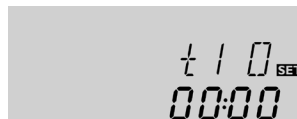

In order to block the thermostat function for a certain period, there are three time frames t1 ... t3. If the function should be active between 6:00 and 9:00, set t1 O to 6:00 and t1 F to 9:00.

If all time frames are set to 00:00 o'clock, the thermostat function is continuously activated (factory setting).

t1 F, t2 F, t3 F:

Thermostat switch-off time
Adjustment range:
00:00...23:45
Factory setting: 00:00

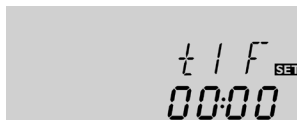

Option: Thermal disinfection of the upper DHW zone (OTD)**OTD:**

Thermal disinfection function
Adjustment range: ON / OFF
Factory setting: OFF

**PDIS:**

Monitoring period
Adjustment range:
0 ... 30:0 ... 24 h (dd:hh)
Factory setting: 01:00

**DDIS**

Heating period
Adjustment range:
00:00 ... 23:59 (hh:mm)
Factory setting: 01:00

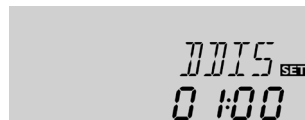
**TDIS**

Disinfection temperature
Adjustment range:
30 ... 200 °F
[0 ... 95 °C]
in steps of 2 °F [1 °C]
Factory setting:
140 °F [60 °C]

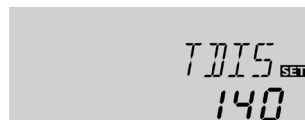

This function is used for protecting the upper tank zone against Legionella by activating the backup heating.

Reference sensor for the thermal disinfection is S3!

➔ To activate the function, select "On" in the **OTD** channel.

For thermal disinfection, the temperature in the upper DHW tank zone has to be monitored. This protection is ensured when, during the monitoring period (**PDIS**), the disinfection temperature (**TDIS**) is continuously exceeded for the entire heating period (**DDIS**). S3 is used as the reference sensor and displayed as **TSTT**.

If **OTD** is activated, **PDIS** will start as soon as the temperature at S3 falls below **TDIS**. In the display channel **CDIS**, the remaining time of **PDIS** is counted backwards. If, during the monitoring period, the temperature at S3 exceeds **TDIS** continuously for the duration of **DDIS**, thermal disinfection is considered complete and a new monitoring period begins.

If **CDIS** counts down to 00:00, relay 2 will be operated in order to use the backup heating for thermal disinfection. **CDIS** will then be replaced with a display channel **DDIS** showing the adjusted heating period. **DDIS** will start counting down the heating period as soon as **TDIS** is exceeded at S3. As long as **DDIS** is active, the temperature at S3 will be displayed as **TDIS** instead of **TSTT**.

If, during **DDIS**, the temperature at S3 exceeds **TDIS** by more than 10 °Ra [5 K], relay 2 is switched off until the temperature falls below **TDIS** + 4 °Ra [2 K].

If, during **DDIS**, the temperature at S3 falls below **TDIS**, the heating period will restart. **DDIS** can only be completed when **TDIS** is exceeded without interruption.

Due to the flexible control logic, the exact time of thermal disinfection is not predictable. In order to set a fixed time for the disinfection to be run, the starting delay **SDIS** must be employed:

When a starting time for thermal disinfection with starting delay is adjusted in **SDIS**, the thermal disinfection will be delayed until that time, even after the **CDIS** has counted down to 00:00. If **CDIS** ends, for example, at 12:00 o'clock, and **SDIS** has been set to 18:30, relay 2 will be operated with a delay of 6.5 hours at 18:30 instead of 12:00.

During the waiting time, **SDIS** is displayed with the adjusted starting time (flashing).

If, during the waiting time, the temperature at S3 exceeds **TDIS** for the adjusted heating period **DDIS**, thermal disinfection is considered complete and a new monitoring period begins.

If the starting time is adjusted to 00:00 (factory setting), the delay function is inactive.

Upon delivery, **OTD** is deactivated. The adjustment values **PDIS**, **TDIS**, **DDIS** and **SDIS** are displayed after the option has been activated. After the thermal disinfection function has been completed, the values will be "hidden" and the monitoring period will be displayed.

Thermal disinfection with starting delay**SDIS**

Starting time
Adjustment range:
00:00 ... 24:00 (o'clock)
in steps of: 00:01
Factory setting: 00:00

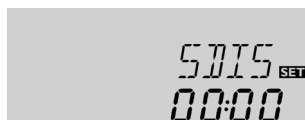

System layout 3

The controller calculates the temperature difference between collector sensor S1 and tank sensor S2. If the difference is larger than or identical to the adjusted switch-on temperature difference (DT O), the solar pump will be operated by relay 1, and the tank will be loaded until the switch-off temperature difference (DT F) or the maximum tank temperature (S MX) is reached. If the maximum collector temperature (CMX) is reached, the solar pump will be operated by relay 1 and the 3-way-valve

will be operated by relay 2 in order to direct the surplus energy to a heat dump. For security purpose this will be carried out only if the tank temperature is below the non-adjustable emergency shutdown of 200 °F. Sensors S3 and S4 can optionally be connected for measurement purposes. S3 can optionally be used as reference sensor for the tank emergency shutdown option (OSEM). If heat quantity measurement (OHQM) is activated, sensor S4 has to be connected as return sensor.

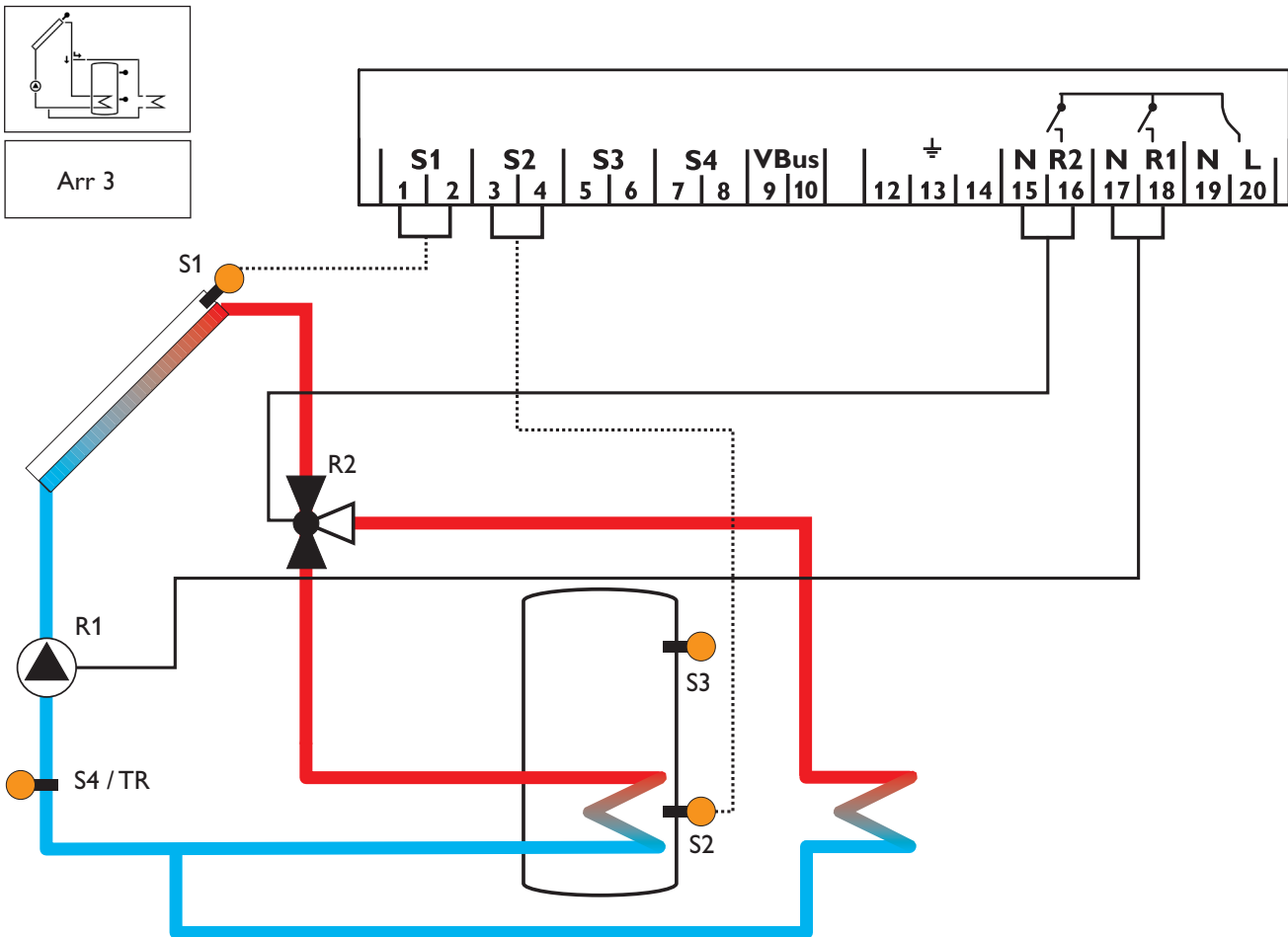

Display Channels				
Channel		Description	Terminal	Page
COL	x	Temperature collector	S1	18
TST	x	Temperature tank	S2	18
S3	x	Temperature sensor 3	S3	18
TSTT	x*	Temperatur tank at the top	S3	18
S4	x	Temperature sensor 4	S4	18
TR	x*	Temperature return sensor	S4	18
n %	x	Pump speed relay	R1	18
h P1	x	Operating hours R1	R1	19
h P2	x	Operating hours R2	R2	19
kWh	x*	Heat quantity kWh	-	19
MWh	x*	Heat quantity MWh	-	19
TIME	x	Time	-	16

Adjustment Channels				
Channel		Description	Factory setting	Page
Arr	x	System	3	20
DT O	x	Switch-on temperature difference	12.0 °Ra [6.0 K]	20
DT F	x	Switch-off temperature difference	8.0 °Ra [4.0 K]	20
DT S	x	Nominal temperature difference	20.0 °Ra [10.0 K]	20
RIS	x	Rise control R1	4 °Ra [2 K]	20
nMN	x	Minimum pump speed	30 %	20
S MX	x	Maximum tank temperature	140 °F [60 °C]	21
OSEM	x	Option tank emergency shutdown	OFF	21
EM	x	Emergency temperature collector	270 °F [130 °C]	21
CMX	s	Maximum collector temperature	230 °F [110 °C]	22
OCN	x	Option minimum limitation	OFF	23
CMN	x*	Minimum collector temperature	50 °F [10 °C]	23
OCF	x	Option antifreeze	OFF	23
CFR	x*	Antifreeze temperature	40.0 °F [4.0 °C]	23
OTC	x	Option tube collector	OFF	24
TCST	x*	OTC starting time	07:00	24
TCEN	x*	OTC ending time	19:00	24
TCRU	x*	OTC runtime	30 s	24
TCIN	x*	OTC standstill interval	30 min	24
OHQM	x	Option energy metering	OFF	24
FMAX	x*	Maximum flow	6.0 l	24
MEDT	x*	Antifreeze type	1	24
MED%	x*	Antifreeze concentration (only if MEDT = propylene or ethylene)	45 %	24
MAN1	x	Manual operation R1	Auto	26
MAN2	x	Manual operation R2	Auto	26
ADA1	x	HE pump control	OFF	26
LANG	x	Language	En	26
UNIT	x	Temperature unit	°C	26
RESE	x	Reset - back to factory defaults		26
W0040100		Version number		

Legend:

Symbol	Specification
x	Channel is available
x*	Channel is available if the corresponding option is activated.
s	Channel is specifically available in this system layout

2. Operation and function

2.1 Push buttons

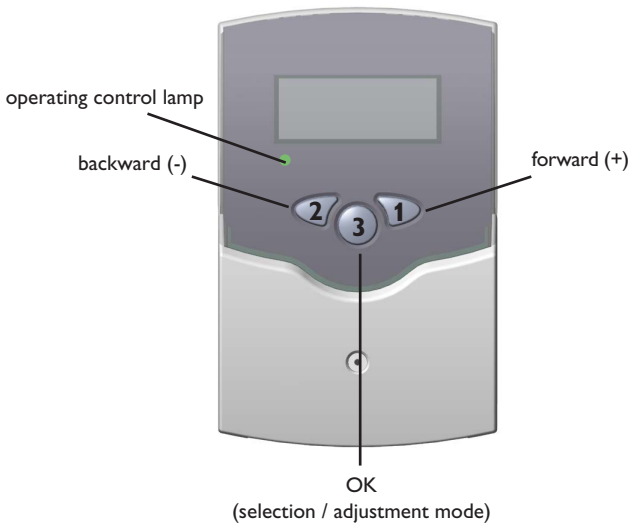

The controller is operated via three push buttons below the display.

Button 1 is used for scrolling forward through the indication menu or to increase the adjustment values. **Button 2** is used for scrolling backward and reducing values. **Button 3** is used for selecting channels and confirming adjustments.

During normal operation, only the display channels are shown.

→ Scroll through the display channels by pressing buttons 1 and 2

Accessing the adjustment channels:

→ Scroll down in the display menu and press button 1 for approx. 2 seconds after you have reached the last display item.

When an **adjustment value** is shown on the display, **SET** is indicated to the right of the channel name.

→ Press button 3 in order to access the adjustment mode **SET** starts flashing.

→ Adjust the value using buttons 1 and 2

→ Briefly press button 3, **SET** permanently appears, the adjusted value will be saved.

2.2 System monitoring display

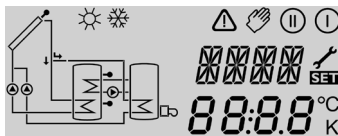

system monitoring display



channel display



tool bar

The system monitoring display consists of three blocks: **channel display**, **tool bar** and **system screen** (active system layout).

The **channel display** consists of 2 lines. The upper line is an alpha-numeric 16-segment display (text display) for displaying channel names and menu items. In the lower 7-segment display, the channel values and the adjustment parameters are displayed.

Temperatures are either indicated in °F or °C, whereas temperature differences are indicated in K or °Ra respectively.

The additional symbols of the **tool bar** indicate the current system status.

Status	standard	flashing
relay 1 active	ⓘ	
relay 2 active	ⓘ	
maximum tank temperature exceeded	☀	
tank emergency shutdown active		⚠ + ☀
collector emergency shutdown active		⚠
collector cooling active	ⓘ	☀
system cooling active	ⓘ	☀
tank cooling active	ⓘ + ☀	
holiday cooling function activated	☀	⚠
holiday cooling function active	ⓘ + ☀	⚠
collector minimum limitation active		❄
antifreeze function activated	❄	
antifreeze function active	ⓘ	❄
manual operation relay 1 ON	☞ + ⓘ	⚠
manual operation relay 2 ON	☞ + ⓘ	⚠
manual operation relay 1 / 2 OFF	☞	⚠
sensor defective	🔧	⚠

System screen

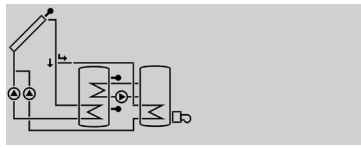

system screen

The system screen (active system layout) shows the system selected on the controller. It consists of several system component symbols, which are – depending on the current status of the system – either flashing, permanently shown or hidden.

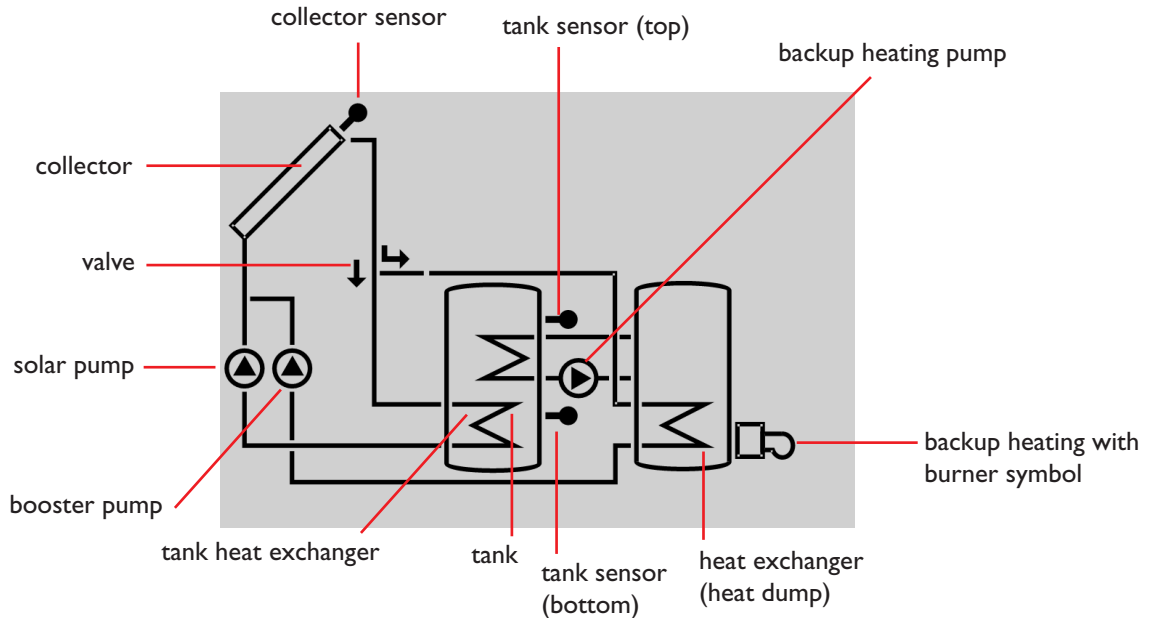

Collector
with collector sensor



Tank
with heat exchanger



3-way valve
The flow direction or the actual switching position is shown



Temperature sensor



Pump

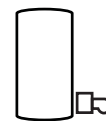

Backup heating
with burner symbol

2.3 Flashing codes

System screen flashing codes

- Pumps are flashing when the corresponding relay is switched on
- Sensor symbols are flashing if the corresponding sensor display channel is selected
- Sensors are flashing quickly in the case of a sensor fault
- Burner symbol is flashing if the backup heating is active

LED flashing codes

- | | |
|---------------------|-------------------------------------|
| green: | everything OK |
| red/green flashing: | initialization phase |
| red flashing: | manual operation |
| | sensor fault |
| | (sensor symbol is flashing quickly) |

3. Commissioning

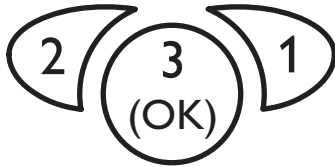

The three pushbuttons of the BS/4 controller

→ Establish the power supply

During a short initialization phase, the operating control lamp flashes red and green.

When the controller is commissioned for the first time or after a reset, it will run a commissioning menu. The commissioning menu leads the user through the most important adjustment channels needed for operating the system.

Operating the commissioning menu:

→ Enter the channel by pressing button 3

The **SET** symbol flashes.

→ Adjust the value by pressing buttons 1 and 2

→ Save the adjustment by pressing button 3 again

The **SET** symbol stops flashing.

→ Press button 1 or 2 to switch to the next or previous channel

The commissioning menu consists of the following 6 channels:

LANG:

Language selection
Selection: dE, En, Fr
Factory setting: En



1. Language

→ Adjust the desired menu language in this channel

- dE : German
- En : English
- Fr : French

UNIT:

Temperature unit selection
Selection: °F, °C
Factory setting: °C



2. Unit

→ Adjust the unit in which temperatures and temperature differences shall be displayed

TIME:

Real time adjustment

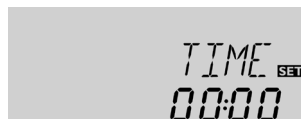

3. Time

→ Adjust the current time for the real time clock

The hours and minutes have to be adjusted separately, first the hours, then the minutes.

Arr:

System layout selection
Adjustment range: 1 ... 3
Factory setting: 1

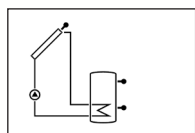

Arr 1

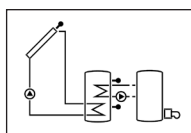

Arr 2

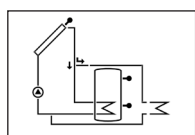

Arr 3

4. System layout

➔ Adjust the desired system layout of your solar thermal system

For a detailed description of the different system layouts selectable, see chapter 1.4.

Overview of system layouts:

- Arr 1 : standard solar system layout
- Arr 2 : solar system layout with backup heating
- Arr 3 : standard solar system layout with heat dump

If the system layout selection is changed later on, any previous adjustments which have been made in the other channels will be lost. Therefore, changing the system layout is always followed by a security enquiry.

Only confirm the security enquiry if you are sure that you wish to change the system layout selection!

Security enquiry:

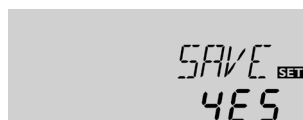

➔ To confirm the security enquiry, press button 3

SMX:

Maximum tank temp.
Adjustment range:
40 ... 200 °F [4 ... 95 °C]
Arr 3:
40 ... 190 °F [4 ... 90 °C]
in steps of 2 °F [1 °C]
Factory setting: 140 °F [60 °C]

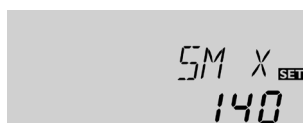

5. Maximum tank temperature

➔ Adjust the desired maximum tank temperature



Note:

The controller is also equipped with a non-adjustable emergency shutdown function, which will shut the system down if the tank reaches 200 °F [95 °C].

nMN:

Pump speed control
Adjustment range:
30 ... 100 %
in steps of 5 %
Factory setting: 30 %

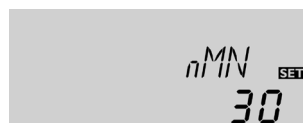

6. Minimum pump speed

➔ Adjust a minimum speed for the pump



Note:

If a load which is not speed-controlled is used, the value must be set to 100 %.

Confirmation enquiry



Completing the commissioning menu

After the last channel of the commissioning menu has been adjusted and confirmed, the controller asks for confirmation of the adjustments.

➔ To confirm the adjustments made in the commissioning menu, press button 3

Now the controller is ready for operation with typical settings to suit the selected system layout.

The settings made in the commissioning menu can be changed later on in the corresponding adjustment channels. Additional functions and options can of course be individually adjusted as well (see chap. 4.2).

4. Channel overview

4.1 Display channels

Indication of drainback time periods

Initialization

INIT:
ODB initialization active

INIT
60

Indicates the time adjusted in **tD_{TO}**, running backwards.

Filling time

FLL:
ODB filling time active

FLL
05:00

Indicates the time adjusted in **tF_{LL}**, running backwards.

Stabilization

STAB:
Stabilization

STAB
02:00

Indicates the time adjusted in **tS_{TB}**, running backwards.

Indication of collector temperature

COL:
Collector temperature
Display range: -40...+500 °F
[-40...+260 °C]

COL
185.0

Indicates the current collector temperature.

Indication of tank temperatures

TST, TSTB, TSTT, TDIS:
Tank temperatures
Display range: -40...+500 °F
[-40...+260 °C]

TST
140.0

Indicates the current tank temperature.

- TST : tank temperature
- TSTB : tank temperature bottom
- TSTT : tank temperature top
- TDIS : thermal disinfection temperature
(replaces TSTT if, during thermal disinfection, the heating period DDIS is active)

TSTB and **TDIS** are available in Arr = 2 only

Indication of sensors 3 and 4

S3, S4:
Sensor temperatures
Display range: -40...+500 °F
[-40...+260 °C]

S3
87.5

Indicates the current temperature of the corresponding additional sensor (without control function).

- S3 : temperature sensor 3 (Arr = 1 and 3 only)
- S4 : temperature sensor 4



Note:

S3 and S4 will only be indicated if the temperature sensors are connected.

Indication of return temperature

TR:
Return temperature
Display range: -40...+500 °F
[-40...+260 °C]

TR
136.4

If energy metering is active, the temperature at sensor 4 is indicated as TR.

Indication of current pump speed**n %:**Current pump speed
Display range: 30...100%**kWh/MWh:** Heat quantity
in kWh / MWh
Display channel

Indicates the current pump speed of the solar pump.

Indicates the energy gained in heat quantity – only available if energy metering (OHQM) is activated.

The flow rate as well as the reference sensors S1 (flow) and S4 (return) are used for calculating the heat quantity supplied. It is shown in kWh in the channel **kWh** and in MWh in the channel **MWh**. The overall heat quantity results from the sum of both values.The accumulated heat quantity can be set back to 0. As soon as one of the display channels of the heat quantity is selected, the **SET** symbol is permanently shown on the display.

→ Press button 3 for about 2 seconds in order to access the RESET mode of the counter.

The display symbol **SET** will flash and the heat quantity value will be set to 0.

→ Confirm the reset with button 3 in order to finish the reset.

In order to interrupt the RESET-process, do not press a button for about five seconds. The display returns to the display mode.

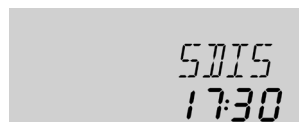
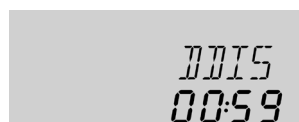
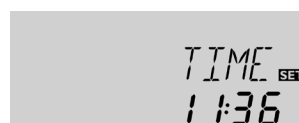
CDISCountdown of monitoring
period
Display range:
0 ... 30:0 ... 24 (dd:hh)**SDIS**Starting time display
Display range:
00:00 ... 24:00 (hh:mm)**DDIS**Heating period display
Display range:
00:00 ... 24:00 (hh:mm)If the thermal disinfection option (**OTD**) is activated and the monitoring period is in progress, the remaining monitoring time will be displayed as **CDIS** (in days and hours) and counted backwards.If the thermal disinfection option (**OTD**) is activated and a starting delay time has been adjusted, the adjusted delay time is displayed (flashing) in this channel.If the thermal disinfection option (**OTD**) is activated and the heating period is in progress, the remaining time of the heating period is displayed (in hours and minutes) in this channel, counting backwards.**TIME**

Indicates the current time.

→ Press button 3 for two seconds to adjust the hours

→ Set the hours by pressing buttons 1 and 2

→ Press button 3 again to adjust the minutes

→ Set the minutes by pressing buttons 1 and 2

→ Press button 3 in order to save the adjustments

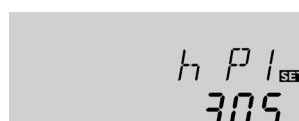
Operating hours counter**h P / h P1 / h P2:**Operating hours counter
Display channelThe operating hours counter accumulates the solar operating hours of the respective relay (**h P / h P1 / h P2**). Full hours are displayed.The accumulated operating hours can be set back to 0. As soon as one operating hours channel is selected, the symbol **SET** is displayed.

→ In order to access the RESET-mode of the counter, press button 3 for approx. 2 seconds.

The display symbol **SET** will flash and the operating hours will be set to 0.

→ Confirm the reset with button 3 in order to finish the reset.

In order to interrupt the RESET-process, do not press a button for about five seconds. The display returns to the display mode.

4.2 Adjustment channels

System layout selection

Arr:

System layout selection.
Adjustment range: 1 ... 3
Factory setting: 1



Security enquiry:



ΔT-regulation

DT O:

Switch-on temperature diff.
Adjustment range: 2.0 ... 40.0 °Ra
[1.0 ... 20.0 K]
in steps of 1 °Ra [0.5 K]
Factory setting: 12.0 °Ra
[6.0 K]

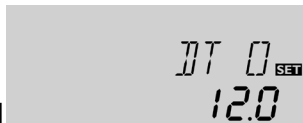

DT F:

Switch-off temperature diff.
Adjustment range: 1.0 ... 39.0 °Ra
[0.5 ... 19.5 K]
in steps of 1 °Ra [0.5 K]
Factory setting: 8.0 °Ra
[4.0 K]

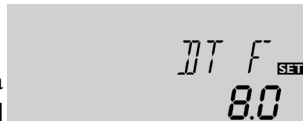

Pump speed control

DT S:

Nominal temperature difference
Adjustment range: 3.0 ... 60.0 °Ra
[1.5 ... 30.0 K]
in steps of 1 °Ra [0.5 K]
Factory setting: 20.0 °Ra
[10.0 K]

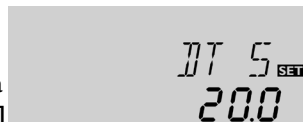

RIS:

Rise
Adjustment range:
2 ... 40 °Ra [1 ... 20 K]
in steps of 2 °Ra [1 K]
Factory setting: 4 °Ra [2 K]



Minimum pump speed

nMN:

Pump speed control
Adjustment range:
30 ... 100 %
in steps of 5 %
Factory setting: 30 %
if ODB is activated: 50 %

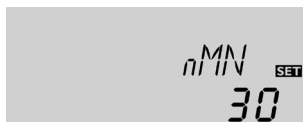

In this channel, a pre-defined system layout can be selected. Each system layout has a set of pre-programmed settings that can be individually changed.

If the system layout selection is changed later on, all adjustments made in the other channels will be lost. Therefore, changing the system layout is always followed by a security enquiry.

Only confirm the security enquiry if you are sure that you wish to change the system layout selection!

→ To confirm the security enquiry, press button 3

The controller works as a standard differential controller. If the switch-on difference is reached, the pump is activated. When the temperature difference falls below the adjusted switch-off temperature difference, the relay switches off.



Note:

The switch-on temperature difference must be at least 1 °Ra [0.5 K] higher than the switch-off temperature difference.



Note:

When the drainback option **ODB** is activated, the temperature differences **DT O**, **DT F** and **DT S** are set to a fixed adjustment:

DT O = 20 °Ra [10 K]

DT F = 8 °Ra [4 K]

DT S = 30 °Ra [15 K]

Previous adjustments made in these channels will be overridden and may have to be entered again if **ODB** is deactivated later on.



Note:

For pump speed control, the operation mode of relay 1 must be set to Auto (adjustment channel **MAN1**)

When the switch-on temperature difference is reached, the pump is activated at full speed for 10 seconds. Then, the speed is reduced to the minimum pump speed value (factory setting = 30 %).

If the temperature difference reaches the adjusted nominal temperature difference, the pump speed increases by one step (10 %). If the difference increases by the adjustable rise value, the pump speed increases by 10 % respectively until the maximum pump speed of 100 % is reached. The response of the controller can be adapted via the parameter "Rise".



Note:

The nominal temperature difference must be at least 1 °Ra [0.5 K] higher than the switch-on temperature difference.

A relative minimum pump speed can be allocated to the output R1 via the adjustment channel **nMN**.



Note:

When a load which is not speed-controlled is used, the value must be set to 100 % in order to deactivate pump speed control.

Maximum tank temperature**SMX:**

Maximum tank temp.

Adjustment range:

40 ... 200 °F [4 ... 95 °C]

Arr 3:

40 ... 190 °F [4 ... 90 °C]

in steps of 2 °F [1 °C]

Factory setting: 140 °F [60 °C]



Once the adjusted maximum temperature is exceeded, the solar pump is switched off and further loading of the tank is prevented to reduce scald risk or system damage. A fixed hysteresis of 4 °Ra [2 K] is set for the maximum tank temperature.

When the temperature at sensor 2 exceeds the adjusted maximum tank temperature, the  symbol is shown on the display.

**Note:**

If the collector cooling or the system cooling function is activated, the adjusted tank temperature may be overridden. In order to prevent system damage, the controller is also equipped with a non-adjustable emergency shutdown if the tank reaches 200 °F [95 °C].

Tank emergency shutdown option**OSEM:**

Tank emergency shutdown option

Adjustment range: ON/OFF

Factory setting: OFF

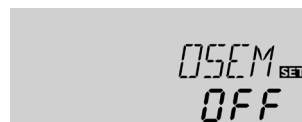

This option is used for activating the integrated tank emergency shutdown for an upper tank sensor. If the temperature at the reference sensor (S3) exceeds 200 °F [95 °C], the tank will be blocked and loading will be stopped until the temperature falls below 190 °F [90 °C].

**Collector temperature limitation
Emergency shutdown of the collector****EM:**

Collector temperature limitation

Adjustment range:

170 ... 390 °F

[80 ... 200 °C]

in steps of 2 °F [1 °C]

Factory setting:

270 °F [130 °C]

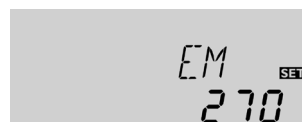

If the adjusted collector emergency shutdown temperature **EM** is exceeded, the controller switches off the solar pump (R1) in order to protect the system against overheating (collector emergency shutdown). A hysteresis of 20 °Ra [10 K] is set for the collector temperature limitation. While the collector is in emergency shutdown,  (flashing) is shown on the display.

**Note:**

If the drainback option **ODB** is activated, the adjustment range of **EM** is changed to 170 ... 250 °F [80 ... 120 °C]. The factory setting in that case is 200 °F [95 °C].

WARNING!**Danger of injury and system damage through pressure surges!**

If water is used as a heat transfer medium in a pressure-less system, the water will start boiling at 212 °F [100 °C].

→ **If a pressure-less drainback system is used with water as a heat transfer medium, do not adjust the collector temperature limitation EM to more than 200 °F [95 °C]!**

Cooling functions

Collector cooling function

OCC:

Option collector cooling
Adjustment range: OFF/ON
Factory setting: OFF



CMX:

Maximum collector temp.
Adjustment range:
150...320 °F
[70 ... 160 °C]
in steps of 1 °F [1 °C]
Factory setting:
230 °F [110 °C]



System cooling function

OSYC:

Option system cooling
Adjustment range: OFF/ON
Factory setting: OFF

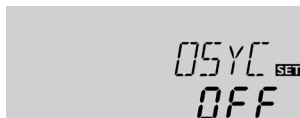

DTCO:

Switch-on temperature diff.
Adjustment range:
2.0 ... 60.0 °Ra
[1.0 ... 30.0 K]
in steps of 1 °Ra [0.5 K]
Factory setting:
40.0 °Ra [20.0 K]



DTCF:

Switch-off temperature diff.
Adjustment range:
1.0 ... 59.0 °Ra
[0.5 ... 29.5 K]
in steps of 1 °Ra [0.5 K]
Factory setting:
30.0 °Ra [15.0 K]

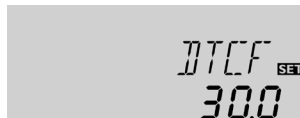

In the following the three cooling functions – collector cooling, system cooling and tank cooling – are described in detail. The following notes are valid for all three cooling functions:



Note:

The cooling functions will not become active as long as solar loading is possible.

When the collector cooling function is activated, the controller aims to keep the collector at an operational temperature. When the adjusted maximum tank temperature is reached, solar loading stops. If the collector temperature increases to the adjusted maximum collector temperature, the solar pump is activated until the collector temperature falls at least 10 °Ra [5 K] below the maximum collector temperature. The tank temperature may increase (subordinate active maximum tank temperature), but only up to 200°F [95 °C] (emergency shutdown of the tank).

If the collector cooling function is active, and (flashing) is shown on the display.



Note:

This function will only be available if the system cooling function (**OSYC**) is deactivated.



Note:

In system layout 3, the parameter **CMX** is available without the **OCC** function. In system layout 3, **CMX** is used to set the activation temperature for the heat dump function. No other switch-on condition is needed in that case.

When the system cooling function is activated, the controller aims to keep the solar system operational for a longer time. The function overrides the maximum tank temperature to provide thermal relief of the collector field and the heat transfer fluid on hot days.

If the tank temperature is higher than the maximum tank temperature **SMX** and the switch-on temperature difference **DTCO** is reached, the solar system remains activated. Solar loading is continued until either the tank temperature reaches 200 °F [95 °C] (emergency shutdown of the tank), the temperature difference falls below the adjusted value **DTCF** or the collector emergency shutdown temperature **EM** is reached.

If the system cooling function is active, and (flashing) is shown on the display.



Note:

This function will only be available if the collector cooling function (**OCC**) is deactivated.

Tank cooling function**OSTC:**

Tank cooling option
Adjustment range: OFF/ON
Factory setting: OFF

**OHOL:**

Holiday cooling option
Adjustment range: OFF/ON
Factory setting: OFF

**THOL:**

Holiday cooling temperature
Adjustment range:
70.0 ... 175.0 °F
[20.0 ... 80.0 °C]
in steps of 1.0 °F [1.0 °C]
Factory setting:
110.0 °F [40.0 °C]

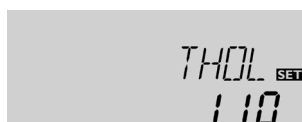

When the tank cooling function is activated, the controller aims to cool down the tank during the night in order to prepare it for solar loading on the following day.

If the adjusted maximum tank temperature **S MX** is exceeded and the collector temperature falls below the tank temperature, the system will be reactivated in order to cool down the tank. Cooling will continue until the tank temperature has fallen below the adjusted maximum tank temperature **S MX** again. A fixed hysteresis of 4 °Ra [2 K] is set for this function.

Reference threshold temperature differences for the tank cooling function are **DT O** and **DT F**.

If no DHW consumption is expected for a longer period of time, the additional holiday cooling option **OHOL** can be activated in order to extend the tank cooling function. The adjustable temperature **THOL** then replaces the maximum tank temperature **S MX** as a switch-off temperature for the tank cooling function.

When the holiday cooling function is activated, ☀ and ⚠ (flashing) are shown on the display.

While the holiday cooling function is active, Ⓛ, ☀ and ⚠ (flashing) are shown on the display.

Collector minimum limitation option**OCN:**

Collector minimum limitation
Adjustment range: OFF / ON
Factory setting: OFF

**CMN:**

Collector minimum temp.
Adjustment range:
50.0...190.0 °F
[10.0 ... 90.0 °C]
in steps of 1.0 °F [0.5 °C]
Factory setting:
50.0 °F [10.0 °C]



If the collector minimum limitation option is activated, the pump (R1) is only switched on if the adjustable collector minimum temperature is exceeded. The minimum temperature prevents the pump from being switched on too often at low collector temperatures. A fixed hysteresis of 10 °Ra [5 °K] is set for this function.

If the collector minimum limitation is active, ☀ (flashing) is shown on the display.

**Note:**

If **OSTC** or **OCF** is active, the collector minimum function will be overridden. In that case, the collector temperature may fall below **CMN**.

Antifreeze option**OCF:**

Antifreeze function
Adjustment range: OFF / ON
Factory setting: OFF

**CFR:**

Antifreeze temperature
Adjustment range:
-40.0 ... +50.0 °F
[-40.0 ... +10.0 °C]
in steps of 1 °F [0.5 °C]
Factory setting:
40.0 °F [4.0 °C]



The antifreeze function activates the loading circuit between the collector and the tank when the temperature falls below the adjusted antifreeze temperature. This will protect the fluid against freezing or coagulating. If the adjusted antifreeze temperature is exceeded by 2 °Ra [1 K], the loading circuit will be deactivated.

When the antifreeze function is activated, ☀ is shown on the display. If the antifreeze function is active, Ⓛ and ☀ (flashing) are shown on the display.

**Note:**

Since this function uses the limited heat quantity of the tank, the antifreeze function should be used in regions with few days of temperatures around the freezing point.

The antifreeze function will be suppressed if the tank temperature falls below 40 °F [5 °C] in order to protect the tank from frost damage.

Evacuated tube collector function

OTC:

Evacuated tube collector function
Adjustment range: OFF/ON
Factory setting: OFF



This function helps overcome the disadvantages caused by the non-ideal sensor position with some tube collectors.

This function operates within an adjusted time frame (beginning at **TCST** and ending at **TCEN**). It activates the collector circuit pump for an adjustable runtime (**TCRU**) between adjustable standstill intervals (**TCIN**) in order to compensate for the delayed temperature measurement.

TCST:

Tube collector function starting time
Adjustment range:
00:00 ... 23:45
in steps of 00:15
Factory setting: 07:00



If the runtime **TCRU** is set to more than ten seconds, the pump will be run at 100 % for the first ten seconds of the runtime. For the remaining runtime, the pump will be run at the adjusted minimum speed **nMN**.

If the collector sensor is defective or the collector is blocked, this function is suppressed or switched off.

TCEN:

Tube collector function ending time
Adjustment range:
00:00 ... 23:45
in steps of 00:15
Factory setting: 19:00



Note:

If the drainback option **ODB** is activated, **TCRU** will not be available. In that case, the runtime is determined by the parameters **tFLL** and **tSTB**.

TCRU:

Tube collector function runtime
Adjustment range: 5 ... 500 s
in steps of 5 s
Factory setting: 30 s



TCIN:

Tube collector function standstill interval
Adjustment range: 1 ... 60 min
in steps of 1 min
Factory setting: 30 min



WARNING!



Danger of injury and system damage through pressure surges!

If a drainback system is filled due to the tube collector function and the heat transfer medium enters very hot collectors, pressure surges can occur.

→ If a pressure-less drainback system is used, **TCST** and **TCEN** must be adjusted such that the system will not be filled during times of potentially strong irradiation!

Energy metering

OHQM: Energy metering
Adjustment range: OFF/ON
Factory setting: OFF



If **OHQM** is activated, the heat quantity gained can be calculated and displayed. Energy metering is possible if a flowmeter is used. To enable energy metering, proceed as follows:

- Read the flow rate (l/min) from the flowmeter at maximum pump speed and adjust it in the **FMAX** channel
- Adjust the heat transfer fluid and the concentration of the antifreeze in the channels **MEDT** and **MED%**.

FMAX: Flow rate in l/min
Adjustment range: 0.5 ... 100.0
in steps of 0.5
Factory setting: 6.0

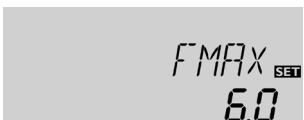

Heat transfer fluid:

- 0 : Water
- 1 : Propylene glycol
- 2 : Ethylene glycol
- 3 : Tyfocor® LS / G-LS

MEDT: Heat transfer fluid
Adjustment range: 0 ... 3
Factory setting: 1



MED%: Antifreeze ratio in Vol-% (MED% is hidden when **MEDT** 0 or 3 is used.)
Adjustment range: 20 ... 70 %
in steps of 1 %
Factory setting: 45 %



Note:

If the system layout 3 has been selected and **OHQM** is activated, energy metering will be interrupted when the 3-way-valve switches to the heat dump.

Drainback option**Note:**

A drainback system layout requires additional components such as a holding tank. The drainback option should only be activated if all components required are properly installed.

**Note:**

The drainback option is only available in system layouts 1 and 2.

ODB:

Drainback option

Adjustment range: OFF/ON

Factory setting: OFF

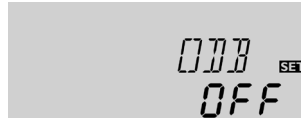
**Note:**

When the drainback option **ODB** is activated, the cooling functions **OCC**, **OSYC** and **OSTC** as well as the antifreeze function **OCF** are not available.

If **OCC**, **OSYC**, **OSTC** or **OCF** have already been activated before, they will be deactivated again as soon as **ODB** is activated. They will remain deactivated, even if **ODB** is deactivated later on.

A drainback system permits the heat transfer fluid to drain back into the holding tank when solar energy is not collected. The drainback option will initiate the filling of the system when solar loading begins.

If the drainback option **ODB** is activated, the pump will operate at 100 % speed for the adjusted filling time **tFLL** in order to fill the system with fluid from the holding tank. After **tFLL**, pump speed will go down to the adjusted minimum pump speed **nMn**. The switch-off conditions will then be ignored for the stabilization time **tSTB** in order to avoid the system from shutting down prematurely.

If the function is activated, the menu items described in the following (**tDTo**, **tFLL** and **tSTB**) have to be adjusted:

**Note:**

When the drainback option **ODB** is activated, the temperature differences **DT O**, **DT F** and **DT S** as well as the minimum speed value **nMN** are set to a fixed adjustment. Additionally, the adjustment range and the factory setting of the collector emergency shutdown temperature **EM** changes (see the corresponding channel descriptions for further information).

Previous adjustments made in these channels will be overridden and have to be entered again if **ODB** is deactivated later on.

Time period - switch-on conditions**tDTo:**

Time period -
switch-on conditions

Adjustment range: 1 ... 100 s

in steps of 1 s

Factory setting: 60 s

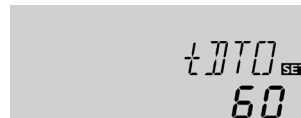

The parameter **tDTo** is used for adjusting the time period during which the switch-on condition **DT O** must be permanently fulfilled.

Filling time**tFLL:**

Filling time

Adjustment range:

1.0 ... 30.0 min

in steps of 0.5 min

Factory setting: 5.0 min

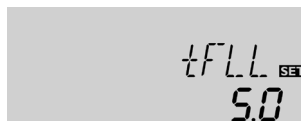

The filling time can be adjusted using the parameter **tFLL**. During this period, the pump runs at 100 % speed.

Stabilization**tSTB:**

Stabilization

Adjustment range:

1.0 ... 15.0 min

in steps of 0.5 min

Factory setting: 2.0 min

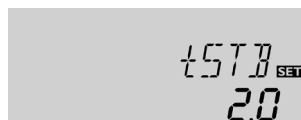

The parameter **tSTB** is used for adjusting the time period during which the switch-off condition **DT F** will be ignored after the filling time has ended.

Booster function option**OBST:**

Booster function

Adjustment range: ON / OFF

Factory setting: OFF



This function is used for switching on a second pump when filling the solar system. When solar loading starts, R2 is energized in parallel to R1. After the filling time (**tFLL**) has ended, R2 is switched off.

**Note:**

The booster function is available in system layout 1 (Arr = 1) only.

The booster function will only be available if the drainback option has been activated.

Operating mode**MAN1 / MAN2:**

Operating mode
Adjustment range:
OFF, Auto, ON
Factory setting: Auto



For control and service work, the operating mode of the controller can be manually adjusted. For this purpose, select the adjustment value **MAN1, MAN2** in which the following adjustments can be made:

• **MAN1 / MAN2**

Operating mode

- OFF : relay off (flashing) +
- Auto : relay in automatic operation
- ON : relay on (flashing) + + /

**Note:**

Always adjust the operating mode back to “Auto” when the control and service work is completed. Normal operation is not possible in manual mode.

HE pump control**ADA1:**

HE pump control
Adjustment range: ON / OFF
Factory setting: OFF



This option is used for controlling a high-efficiency pump via a VBus®/PWM adaptor. The power supply of the pump takes place via the semiconductor relay (R1). For pump speed control with activated ADA1 option, the relay is switched on or off (no pulse packets). Temperature dependent speed information is transmitted via the VBus®. The relay will remain deactivated for 1 hour after its switch-off conditions have been fulfilled (pump protection).

Language**LANG:**

Language selection
Selection: dE, En, Fr
Factory setting: En



The menu language can be adjusted in this channel.

- dE : German
- En : English
- Fr : French

Unit**UNIT:**

Temperature unit selection
Selection: °F, °C
Factory setting: °C



In this adjustment channel, the display unit for temperatures and temperature differences can be chosen. The unit can be switched between °C / K and °F / °Ra during operation. Temperatures and temperature differences in °F and °Ra are displayed without units. If the indication is set to °C, the units are displayed with the values.

Reset**RESE**

Reset function



By using the reset function, all adjustments will be set back to the factory settings.

➔ To initiate a reset, press button 3

Any previous adjustments will be lost. Therefore, initiating the reset function is always followed by a security enquiry.

Only confirm the security enquiry if you are sure that you wish to reset all adjustments to the factory settings!

➔ To confirm the security enquiry, press button 3

**Note:**

Whenever a reset has been completed, the controller runs the commissioning menu again (see chap. 3).

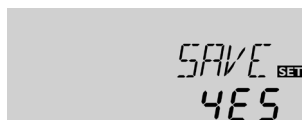
Security enquiry:

5. Troubleshooting

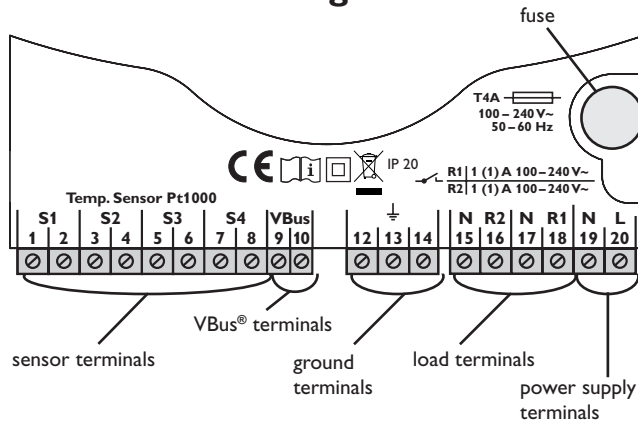

In the case of an error, a message is shown on the display of the controller:

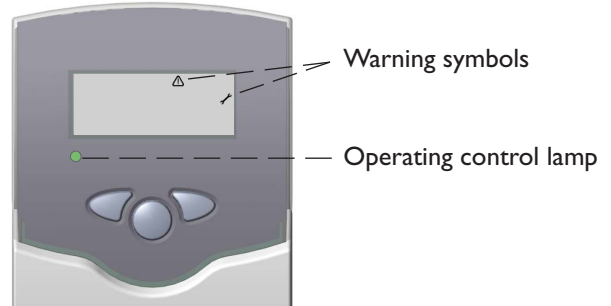

Operating control lamp flashes red. On the display the symbols and appear.

Sensor defect. An error code instead of a temperature is displayed in the sensor display channel.

888.8

- 88.8

Cable broken. Check cable.

Short circuit. Check cable.

Disconnected Pt1000 temperature sensors can be checked with an ohmmeter. In the following table, the resistance values with the corresponding temperatures are shown.

°C	°F	Ω	°C	°F	Ω
-10	14	961	55	131	1213
-5	23	980	60	140	1232
0	32	1000	65	149	1252
5	41	1019	70	158	1271
10	50	1039	75	167	1290
15	59	1058	80	176	1309
20	68	1078	85	185	1328
25	77	1097	90	194	1347
30	86	1117	95	203	1366
35	95	1136	100	212	1385
40	104	1155	105	221	1404
45	113	1175	110	230	1423
50	122	1194	115	239	1442

Resistance values of the Pt1000-sensors

Operating control lamp off.

Check the power supply. Is it disconnected?

no

yes

The fuse of the controller could be blown. It can be replaced after the front cover has been removed (spare fuse is enclosed in the accessory bag).

Check the supply line and reconnect it.

5.1 Various

Pump is overheated, but no heat transfer from the collector to the tank, flow and return have the same temperature; perhaps also air / gas bubbles in the lines.

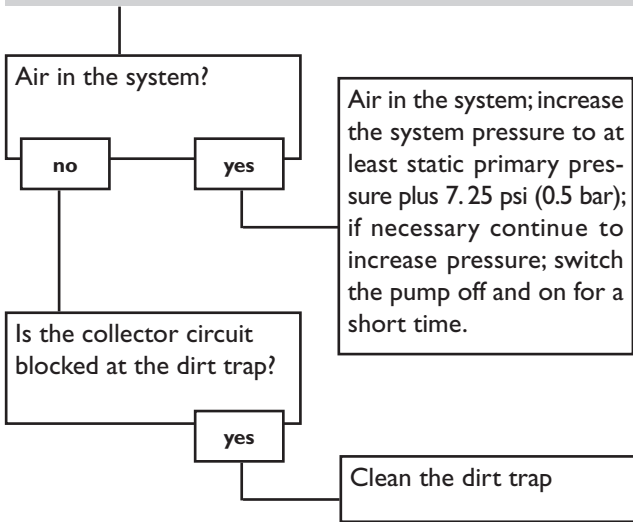

Pump starts for a short moment, switches off, switches on again, etc.

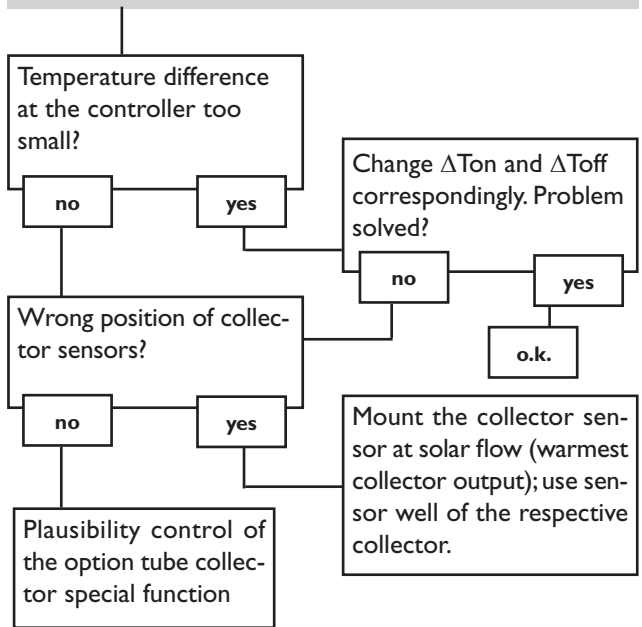

Pump starts up very late

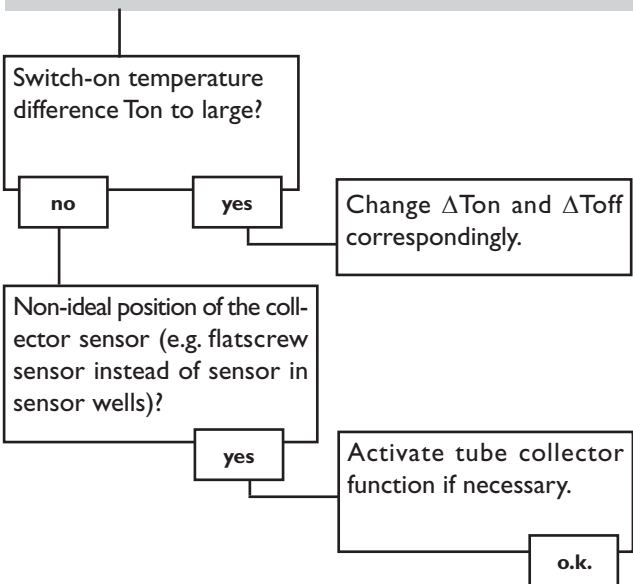

The temperature difference between tank and collector increases enormously during operation; the collector circuit cannot dissipate the heat.

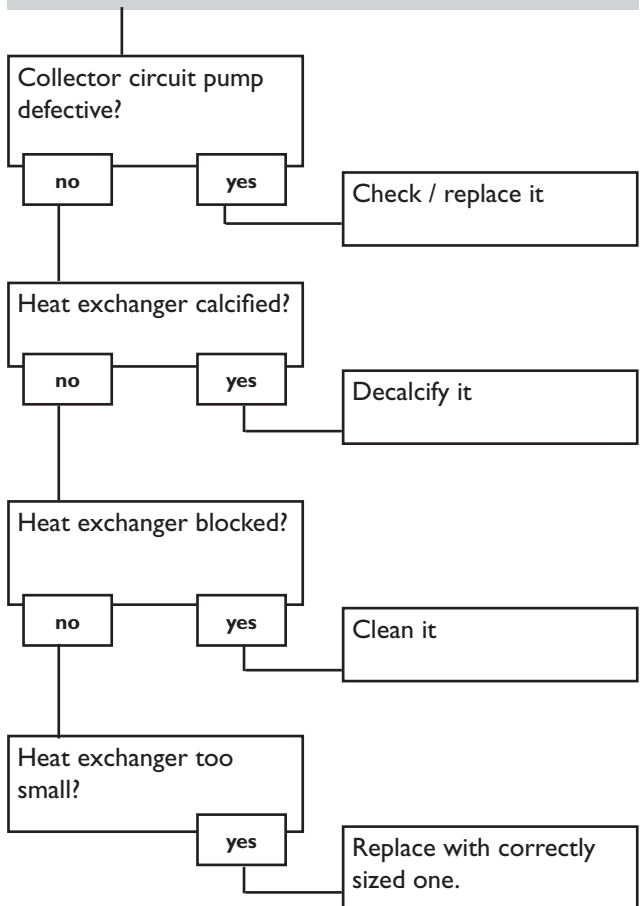

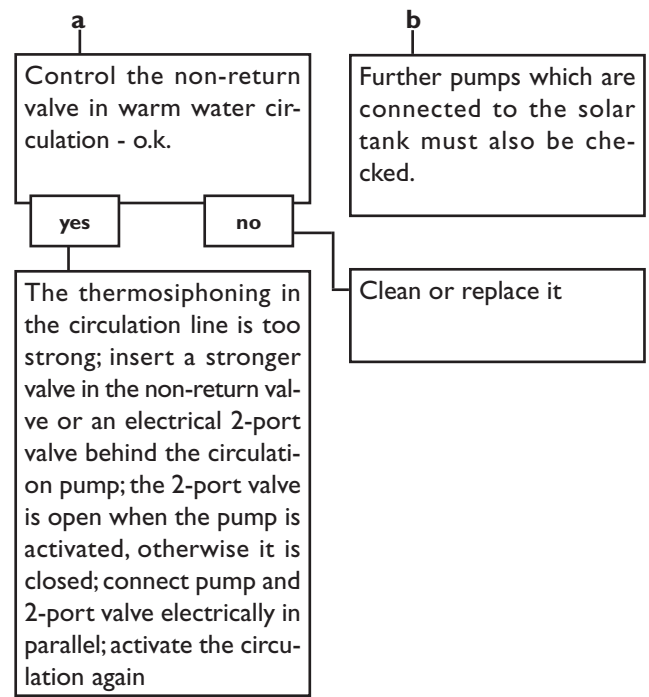
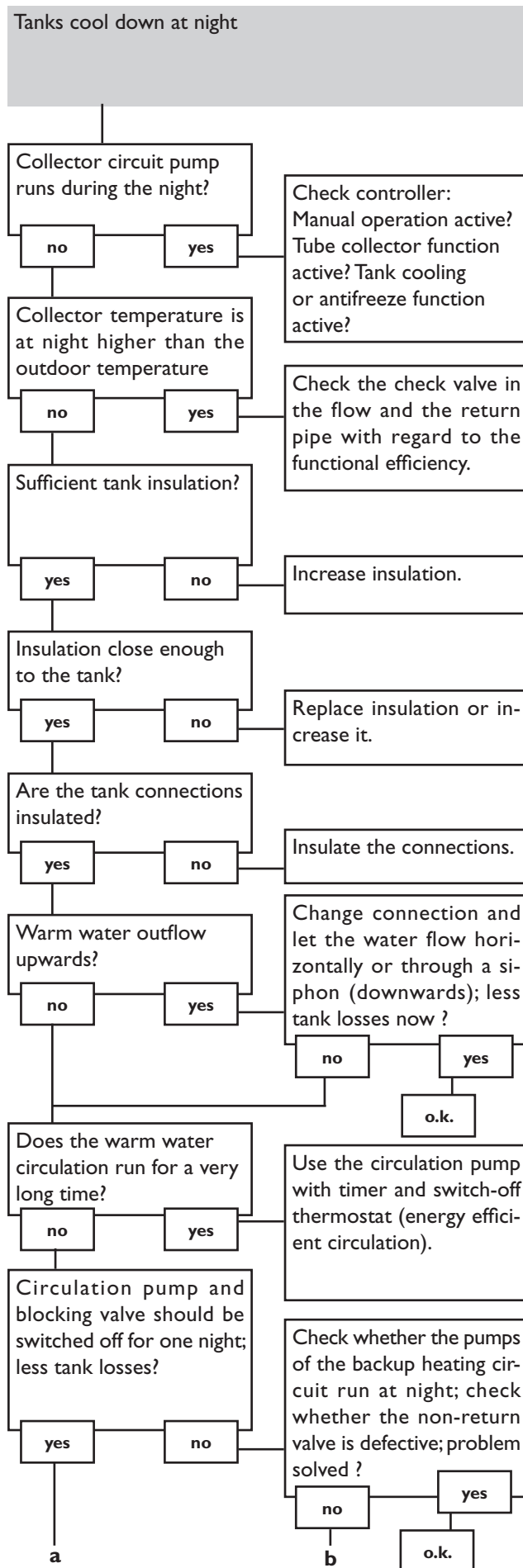

The solar circuit pump does not work, although the collector is considerably warmer than the tank.

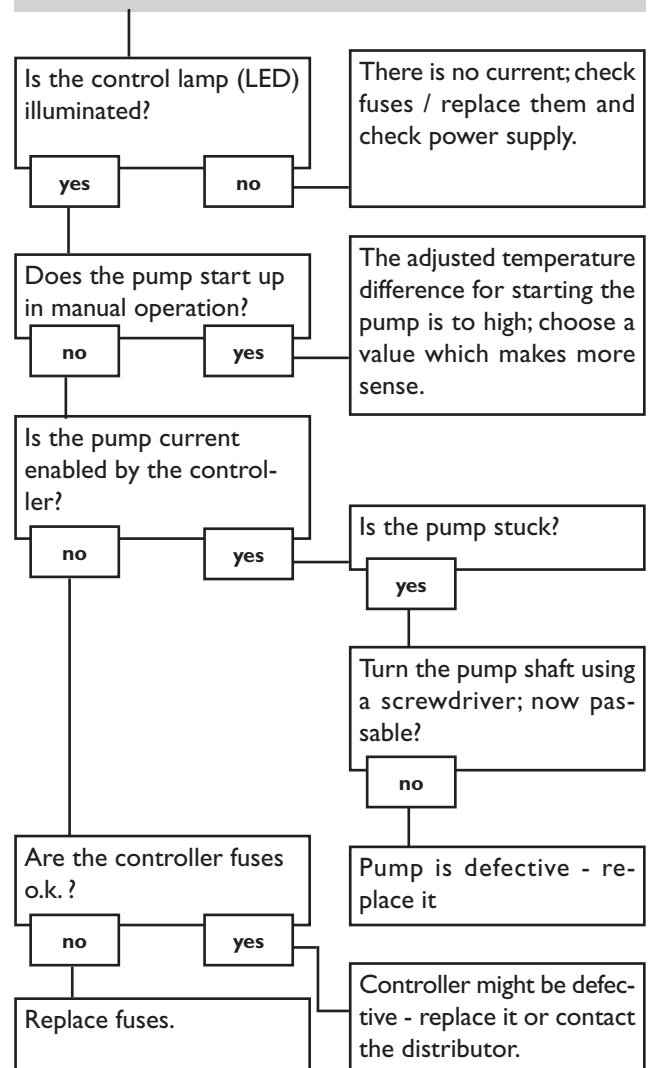

6. Accessories

Sensors

Our product range includes high-precision platinum temperature sensors, flatscrew sensors, outdoor temperature sensors, indoor temperature sensors, cylindrical clip-on sensors, also as complete sensors with immersion sleeve.

For more information, see our catalogue and price list.



Overvoltage protection device

In order to avoid overvoltage damage at collector sensors (e.g. caused by local lightning storms), we recommend the overvoltage protection RESOL SP10.

RESOL RSP10

Article no.: **180 110 70**



Smart Display SD3

The Smart Display is designed for simple connection to controllers with RESOL VBus®. It is used for visualizing data issued by the controller: collector temperature, storage temperature and energy yield of the solar thermal system. The use of high-efficient LEDs and filter glass assures a high optical brilliance and good readability even in poor visibility conditions and from a larger distance. An additional power supply is not required.

RESOL SD3 (unit °C)

Article no.: **180 004 90**

RESOL SD3 (unit °F)

Article no.: **180 007 77**



Large Display GA3

The Large Display GA3 is designed for simple connection to controllers via the RESOL VBus®. It is used for visualizing the data issued by the controller: collector and tank temperature as well as heat quantity produced in the solar system.

The use of high-efficient LEDs and antireflective filter glass assures a high optical brilliance and good readability - even in poor lighting conditions and at a larger distance.

RESOL GA3 (unit °C)

Article no.: **180 006 50**

RESOL GA3 (unit °F)

Article no.: **180 007 87**



DL2 Datalogger

This additional module enables the acquisition and storage of large amounts of data (such as measuring and balance values of the solar system) over a long period of time. The DL2 can be configured and read-out with a standard internet browser via its integrated web interface. For transmission of the data stored in the internal memory of the DL2 to a PC, an SD card can be used.

The DL2 is appropriate for all controllers with RESOL VBus®. It can be connected directly to a PC or router for remote access and thus enables comfortable system monitoring for yield monitoring or for diagnostics of faults.

RESOL DL2Article no.: **180 007 10****VBus® / USB interface adaptor**

The new RESOL VBus® / USB interface adaptor is the interface between the controller and a personal computer. With its standard mini-USB port it enables a fast transmission of system data via the RESOL VBus® for processing, visualizing and archiving. A full version of the ServiceCenter software is included.

RESOL VBus® / USB interface adaptorArticle no.: **180 008 50****VBus® / LAN interface adaptor**

The RESOL VBus® / LAN interface adaptor is designed for the direct connection of the controller to a PC network or router. It enables easy access to the controller via the local network of the owner. Thus, controller access and data charting can be effected from every workstation of the network. A full version of the ServiceCenter software is included.

RESOL VBus® / LAN interface adaptorArticle no.: **180 008 80****VBus® / PWM interface adaptor**

The RESOL VBus® / PWM interface adaptor is used for the speed control of a pump via a PWM or 0-10V signal. Via the VBus®, the adaptor receives information from the controller about the necessary pump speed. The speed is converted into a PWM or direct voltage signal and put out to the corresponding terminals.

RESOL VBus® / PWM interface adaptorArticle no.: **180 008 60****AM1 Alarm module**

The AM1 alarm module is designed to signal system failures. It is to be connected to the RESOL VBus® of the controller and issues an optical signal via a red LED if a failure has occurred. The AM1 also has a dry contact relay output, which can e. g. be connected to a building management system (BMS). Thus, a collective error message can be issued in the case of a system failure.

RESOL AM1 Alarm moduleArticle no.: **180 008 70**

Distributed by:**RESOL - Elektronische Regelungen GmbH**

Heiskampstraße 10
45527 Hattingen / Germany

Tel.: +49 (0) 23 24 / 96 48 - 0

Fax: +49 (0) 23 24 / 96 48 - 755

www.resol.com

info@resol.com

Important notice:

The texts and drawings in this manual are correct to the best of our knowledge. As faults can never be excluded, please note: Your own calculations and plans, under consideration of the current standards should only be basis for your projects. We do not offer a guarantee for the completeness of the drawings and texts of this manual - they only represent some examples. They can only be used at your own risk. No liability is assumed for incorrect, incomplete or false information and / or any resulting damages.

Please note:

The design and the specifications can be changed without prior notice.
The illustrations may differ from the original product.

Reprinting / copying

This mounting- and operation manual including all parts is copyrighted. Another use outside the copyright requires the approval of RESOL - Elektronische Regelungen GmbH. This especially applies for copies, translations, micro-films and the storage into electronic systems.

Editor: RESOL - Elektronische Regelungen GmbH