

DeltaSol® BX L

RESOL®

Manual for the
specialised craftsman

Installation
Operation
Functions and options
Troubleshooting



48006810

Thank you for buying this RESOL product.

Please read this manual carefully to get the best performance from this unit. Please keep this manual carefully.

en

Manual

www.resol.com

Safety advice

Please pay attention to the following safety advice in order to avoid danger and damage to people and property.

Target group

These instructions are exclusively addressed to authorised skilled personnel.

Only qualified electricians should carry out electrical works.

Description of symbols

WARNING! Warnings are indicated with a warning triangle!



→ They contain information on how to avoid the danger described.

Signal words describe the danger that may occur, when it is not avoided.

- **WARNING** means that injury, possibly life-threatening injury, can occur.
- **ATTENTION** means that damage to the appliance can occur.



Note

Notes are indicated with an information symbol.

→ Arrows indicate instruction steps that should be carried out.

Information about the product

Proper usage

The solar controller is designed for use in 2-store and 3-store solar thermal systems in compliance with the technical data specified in this manual.

Improper use excludes all liability claims.

CE-Declaration of conformity

The product complies with the relevant directives and is therefore labelled with the CE mark. The Declaration of Conformity is available upon request, please contact RESOL.



Note

Strong electromagnetic fields can impair the function of the controller.

→ Make sure the controller as well as the system are not exposed to strong electromagnetic fields.

Disposal

- Dispose of the packaging in an environmentally sound manner.
- At the end of its working life, the product must not be disposed of as urban waste. Old appliances must be disposed of by an authorised body in an environmentally sound manner. Upon request we will take back your old appliances bought from us and guarantee an environmentally sound disposal of the devices.



Contents

1	Overview	3
2	Installation	4
2.1	Mounting	4
2.2	Electrical connection	4
2.3	Data communication / Bus	5
2.4	SD memory card slot	5
2.5	Overview of basic system layouts	6
2.6	System layouts	7
3	Operation and function	35
3.1	Buttons	35
3.2	Selecting menu points and adjusting values	35
3.3	Menu structure	35
3.4	Shortcut	36
3.5	Indications and system monitoring display	36
3.6	Further indications	38
4	Status menu	38
5	Initial commissioning	38
6	Functions and options	41
6.1	Status level	41
6.2	Adjustment channels	43
6.3	Overview of options and their parameters	42
7	User code and short menu - Adjustment values	64
8	Messages	64
9	Troubleshooting	65
9.1	Miscellaneous	66
10	Accessories	68
10.1	Sensors and measuring instruments	68
10.2	Interface adapters	69
10.3	Visualisation modules	69
11	Index	70

1 Overview

- Extra large graphic display
- 4 relay outputs
- 5 sensor inputs
- Data logging onto SD card
- Thermal disinfection
- Time-controlled thermostat function
- RESOLVBus®
- Energy-saving switch-mode power supply



Note

For more information about accessories, see p. 55.

Technical data

Housing: plastic, PC-ABS and PMMA

Protection type: IP 20/EN 60529

Protection class: I

Ambient temp.: 0 ... 40 °C

Dimensions: 204 x 170 x 47 mm

Mounting: wall mounting, also suitable for mounting into patch panels

Display: System-Monitoring-Display for system visualisation, 16-segment display, 7-segment display, 9 symbols, control lamp (directional pad) and background illumination

Operation:

7 push buttons at the front of the housing

Functions: Controller for multi-store solar thermal systems. Functions such as: ΔT control, pump speed control, heat quantity measurement, operating hours counter for the solar pump, tube collector function, thermostat function, store loading in layers, priority logic, heat dump function, thermal disinfection function, function control according to BAFA guidelines.

Inputs: 5 inputs for Pt1000 temperature sensors, 1 V40 impulse input

Outputs: 3 semiconductor relays, 1 standard relay

Interfaces: RESOLVBus®, SD card slot

Power supply: 100 ... 240 V~, 50 ... 60 Hz

Switching capacity per relay:

1 (1) A 100 ... 240 V~ (semiconductor relay)

4 (1) A 100 ... 240 V~ (standard relay)

Total switching capacity: 4 A

Standby power consumption: < 1W

Mode of operation: type 1.Y

2 Installation

2.1 Mounting

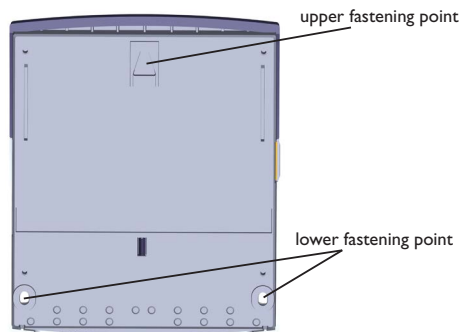
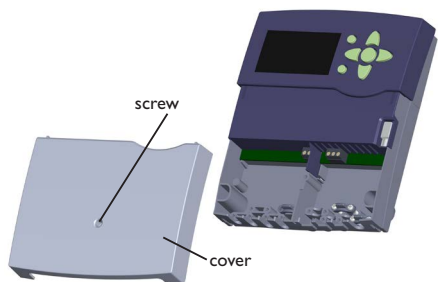

WARNING! Electric shock!



Upon opening the housing, live parts are exposed.

→ **Always disconnect the controller from power supply before opening the housing!**



Note

Strong electromagnetic fields can impair the function of the controller.

→ Make sure the controller as well as the system are not exposed to strong electromagnetic fields.

The unit must only be located in dry interior rooms. The controller must additionally be supplied from a double pole switch with contact gap of at least 3 mm. Please pay attention to separate routing of sensor cables and mains cables.

In order to mount the device to the wall, carry out the following steps:

- Unscrew the cross-head screw from the cover and remove it along with the cover from the housing.
- Mark the upper fastening point on the wall. Drill and fasten the enclosed wall plug and screw leaving the head protruding.
- Hang the housing from the upper fastening point and mark the lower fastening points (centres 150 mm).
- Insert lower wall plugs.
- Fasten the housing to the wall with the lower fastening screws and tighten.
- Carry out the electrical wiring in accordance with the terminal allocation, see chap. 2.2.
- Put the cover on the housing.
- Attach with the fastening screw.

2.2 Electrical connection

ATTENTION! ESD damage!



Electrostatic discharge can lead to damage to electronic components!

→ **Take care to discharge properly before touching the inside of the device! To do so, touch a grounded surface such as a radiator or tap!**



Note

The pump speed must be set to 100 % when auxiliary relays or valves are connected.

WARNING! Electric shock!



Upon opening the housing, live parts are exposed.

→ **Always disconnect the controller from power supply before opening the housing!**

The controller is supplied with power via a mains cable. The power supply of the device must be 100 ... 240 V~ (50 ... 60 Hz).

The controller is equipped with 4 relays in total to which loads such as pumps, valves, etc. can be connected:

- The relays R1 ... R3 are semiconductor relays, designed for pump speed control:
 - Conductor R1 ... R3
 - Neutral conductor N
 - Protective conductor \ominus
- Relay 4 is a standard relay
 - Conductor R4
 - Neutral conductor N
 - Protective conductor \ominus



Note

Connecting the device to the power supply must always be the last step of the installation!

Depending on the product version, mains cables and sensor cables are already connected to the device. If that is not the case, please proceed as follows:

Connect the **temperature sensors** (S1 to S5) to the corresponding terminals with either polarity:

S1 = Sensor 1 (collector sensor)

S2 = Sensor 2 (e.g. store sensor base)

S3 = Sensor 3 (e.g. collector sensor collector 2)

S4 = Sensor 4 (e.g. store sensor store 2)

S5 = Sensor 5 (e.g. store sensor store 3)

A **V40** flowmeter can be connected to the terminals V40 and GND (either polarity).

The **mains connection** is at the terminals:

Neutral conductor N

Conductor L

Conductor L' (L' is not connected with the mains cable. L' is a fused contact permanently carrying voltage)

Protective conductor



Note

The connection depends on the system layout selected, see chap. „2.6 System layouts“ on page 7.



Note

For more details about initial commissioning, see chap. 5, page 39.

WARNING! Electric shock!



L' is a fused contact permanently carrying voltage.

→ **Always disconnect the controller from power supply before opening the housing!**

2.3 Data communication / Bus

The controller is equipped with the RESOL VBus® for data transfer with and energy supply to external modules. The connection is carried out at the two terminals marked “VBus” and “GND” (either polarity). One or more RESOL VBus® modules, depending on their current consumption and the current supply of the controller, can be connected via this data bus, such as:

- RESOL GA3 Large Display module / Smart Display SD3
- RESOL AM1 Alarm module
- RESOL DL2 Datalogger

Furthermore, the controller can be connected to a PC via the RESOL VBus®/USB or VBus®/LAN interface adapter (not included with the DeltaSol® BX L).

With the **RESOL ServiceCenter Software (RSC)**, measured values can be read, processed and visualised.



Note

For more information about accessories, see p. 68.

2.4 SD memory card slot

The controller is equipped with an SD card slot for storing system data onto an SD card. The values can be opened and visualised, e.g. in a spreadsheet programme.



A standard SD card is not included with the DeltaSol® BX L, but can also be purchased at RESOL.

For more information about using an SD card, see page 61, “SD card”.

Standard SD and SD-HC cards can be used.

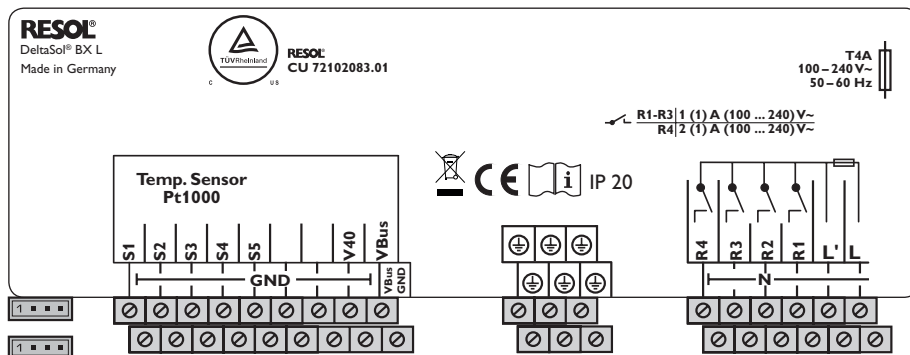

2.5 Overview of basic system layouts

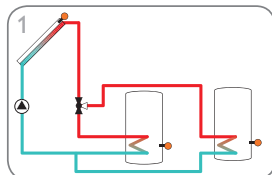

2-store system with valve logic, 1 pump, 3 sensors and 3-port valve (page 7)

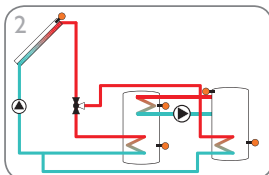

2-store solar system with valve logic and heat exchange control (page 10)

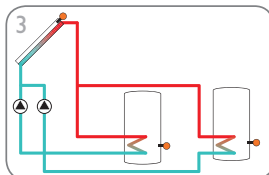

2-store solar system with pump logic (page 13)

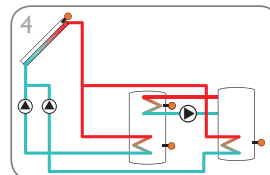

2-store solar system with pump logic and heat exchange control (page 16)

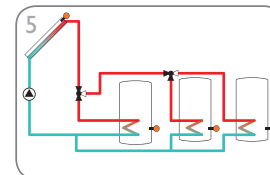

3-store solar system with valve logic and heat exchange control (page 19)

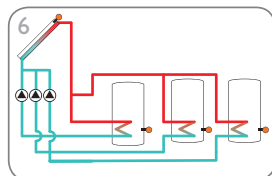

3-store solar system with pump logic and heat exchange control (page 22)

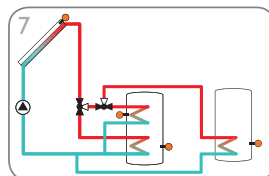

Solar system with store loading in layers and 2 stores (page 25)

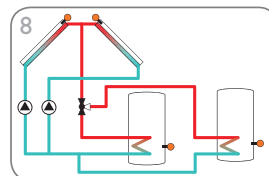

Solar system with east-/west collectors and 2 stores (valve logic) (page 28)

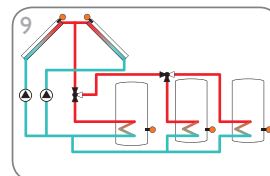

3-store solar system with east-/west collectors (page 31)

2.6 System layouts

System 1

2-store system with valve logic, 1 pump, 3 sensors and 3-port valve

The controller compares the temperature at sensor S1 to the temperatures at sensors S2 and S4. If the measured temperature differences are higher than the adjusted switch-on temperature differences, the

pump (R1) will be activated and the corresponding store will be loaded up to the adjusted maximum temperature via the valve (R3). Store 1 is loaded with priority.

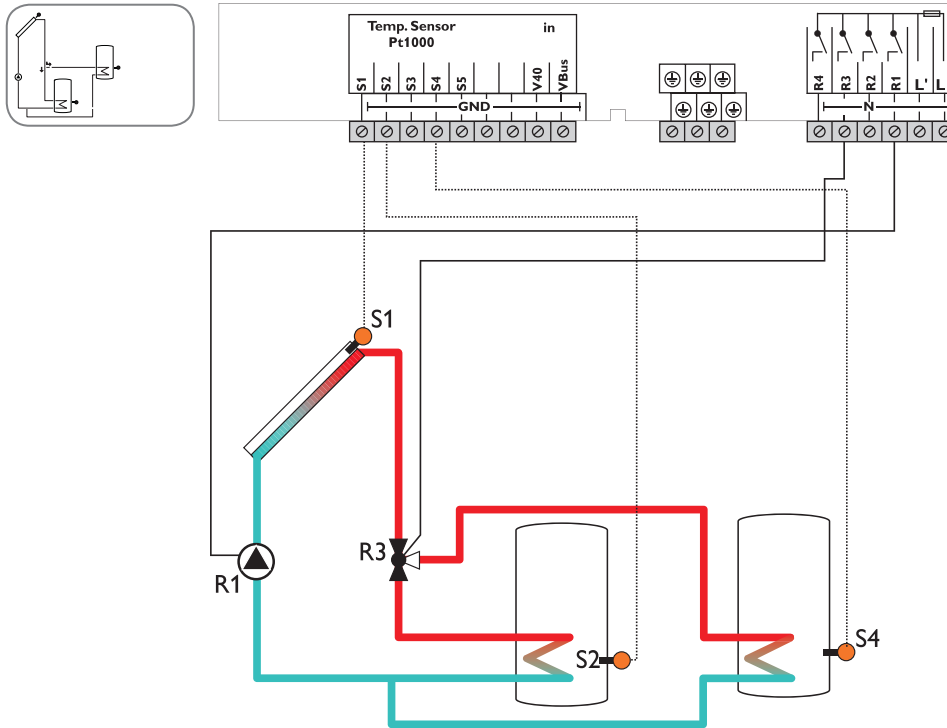

Sensor/terminal	Designation	Description
S1	TCOL	Temperature collector
S2	TST1B	Temperature store 1 base
S3		Optional sensor for measurement purposes or options
S4	TST2B	Temperature store 2 base
S5		Optional sensor for measurement purposes or options
V40		

Relay	Description
R1	Solar pump
R2/R4	optional: Thermal disinfection Parallel relay Heat dump
R3	3-port valve store 1/2

Note: 3-port valve normally open - store 1 (S2)

Adjustment channels						
Channel	Sub channel 1	Sub channel 2	Factory setting	Change to	Description	Page
ARR			1		System	43
ROSA			0000	5	ROSA number	60
LOAD1 >					Loading 1	
	DT1O		6 K		Switch-on temperature difference 1	44
	DT1F		4 K		Switch-off temperature difference 1	44
	DT1S		10 K		Set temperature difference 1	44
	RIS1		2 K		Rise 1	44
	S1MAX		60 °C		Store maximum limitation 1	44
	SMXS1		2		Sensor store max 1	44
LOAD2 >					Loading 2	
	DT2O		6 K		Switch-on temperature difference 2	44
	DT2F		4 K		Switch-off temperature difference 2	44
	DT2S		10 K		Set temperature difference 2	44
	RIS2		2 K		Rise 2	44
	S2MAX		60 °C		Store maximum limitation 2	44
	SMXS2		4		Sensor store max 2	44
	LST2		ON		Loading store 2	45
COL >					Collector	
	CEM		130 °C		Collector emergency temperature	46
	OCCO*		OFF		Collector cooling option	46
		CMAX	110 °C		Collector maximum temperature	46
	OCMN		OFF		Collector minimum limitation option	46
		CMIN	10 °C		Minimum collector temperature	46
	OTCO		OFF		Tube collector function option	46
		TCST	07:00		Tube collector starting time	47
		TCEN	19:00		Tube collector ending time	47
		TCRU	30 s		Tube collector runtime	47
		TCIN	30 min		Tube collector standstill interval	47
	OCFR		OFF		Collector frost protection option	47
		CFR O	4 °C		Antifreeze temperature collector on	47
		CFR F	5 °C		Antifreeze temperature collector off	48
		FRPST	1		Antifreeze store selection	48
LLOGI >					Loading logic	
	LOGIC		PRIO		Priority logic	48

Adjustment channels

Channel	Sub channel 1	Sub channel 2	Factory setting	Change to	Description	Page
	PRI01		1		Priority logic store 1	48
	OSTS		OFF		Store set option	50
		TST1	45 °C		Set store temperature store 1	50
		TST2	45 °C		Set store temperature store 2	50
	tLB		2 min		Loading break time	48
	tRUN		15 min		Circulation runtime	48
	PSPEE		OFF		Pause speed option	51
	PDELA		OFF		Pump delay option	51
COOL >					Cooling functions	
	OSYC*		OFF		System cooling	51
	OSTC		OFF		Store cooling	52
	OHDP*		OFF		Heat dump	52
ODTFT >					ΔT function option	54
OTH >					Thermostat function option	56
PUMP >					Speed	
	PUMP1		OnOF		Speed variant pump 1	45
	PUMP2		OnOF		Speed variant pump 2	45
	PUMP3		OnOF		Speed variant pump 3	45
MAN >					Manual mode	
	MAN1		Auto		Manual mode 1	56
	MAN2		Auto		Manual mode 2	56
	MAN3		Auto		Manual mode 3	56
	MAN4		Auto		Manual mode 4	56
BLPR >			OFF		Blocking protection	56
OTDIS >			OFF		Thermal disinfection option	57
OPARR >			OFF		Parallel relay option	58
OHQM >			OFF		Heat quantity measurement option	58
DATE>					Enter date	60
LANG >			dE		Language	61
UNIT >			°C		Unit	60
OSDC >					SD card option	61
CODE			0000		User code	64
RESET			OFF		Factory setting	

* are blocked against each other

System 2

2-store solar system with valve logic and heat exchange control

The controller compares the temperature at sensor S1 to the temperatures at sensors S2 and S4. If the measured temperature differences are higher than the adjusted switch-on temperature differences, the

pump (R1) will be activated and the corresponding store will be loaded up to the adjusted maximum temperature via the valve (R3). Store 1 is loaded with priority. Heat exchange from store 2 to store 1 (R2)

is possible with another temperature differential function (S3-heat sink/S5-heat source).

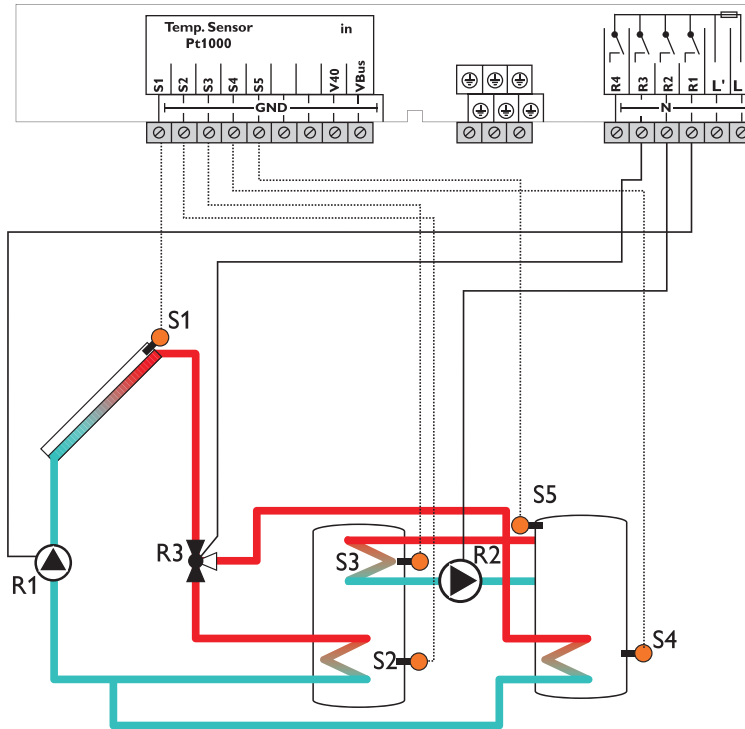
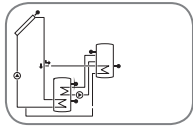

Sensor/terminal	Designation	Description
S1	TCOL	Temperature collector
S2	TST1B	Temperature store 1 base
S3	TST1T	Temperature store 1 top
S4	TST2B	Temperature store 2 base
S5	TST2T	Temperature store 2 top
V40		optional: flowmeter

Relay	Description
R1	Solar pump
R2	Heat exchange pump
R3	3-port valve store 1/2
R4	optional: Thermal disinfection Parallel relay Heat dump

Note: 3-port valve normally open - store 1 (S2)

Adjustment channels

Channel	Sub channel 1	Sub channel 2	Factory setting	Change to	Description	Page
ARR			1	2	System	43
ROSA			0000	16	ROSA number	60
LOAD1 >					Loading 1	
	DT1O		6 K		Switch-on temperature difference 1	44
	DT1F		4 K		Switch-off temperature difference 1	44
	DT1S		10 K		Set temperature difference 1	44
	RIS1		2 K		Rise 1	44
	S1MAX		60 °C		Store maximum limitation 1	44
	SMXS1		2		Sensor store max 1	44
LOAD2 >					Loading 2	
	DT2O		6 K		Switch-on temperature difference 2	44
	DT2F		4 K		Switch-off temperature difference 2	44
	DT2S		10 K		Set temperature difference 2	44
	RIS2		2 K		Rise 2	44
	S2MAX		60 °C		Store maximum limitation 2	44
	SMXS2		4		Sensor store max 2	44
	LST2		ON		Loading store 2	45
COL >					Collector	
	CEM		130 °C		Collector emergency temperature	46
	OCCO*		OFF		Collector cooling option	46
		CMAX	110 °C		Collector maximum temperature	46
	OCMN		OFF		Collector minimum limitation option	46
		CMIN	10 °C		Minimum collector temperature	46
	OTCO		OFF		Tube collector function option	46
		TCST	07:00		Tube collector starting time	47
		TCEN	19:00		Tube collector ending time	47
		TCRU	30 s		Tube collector runtime	47
		TCIN	30 min		Tube collector standstill interval	47
	OCFR		OFF		Collector frost protection option	47
		CFR O	4 °C		Antifreeze temperature collector on	47
		CFR F	5 °C		Antifreeze temperature collector off	48
		FRPST	1		Antifreeze store selection	48
LLOGI >					Loading logic	
	LOGIC		PRIO		Priority logic	48
	PRIO1		1		Priority logic store 1	48
	OSTS		OFF		Store set option	50
		TST1	45 °C		Set store temperature store 1	50
		TST2	45 °C		Set store temperature store 2	50

Adjustment channels

Channel	Sub channel 1	Sub channel 2	Factory setting	Change to	Description	Page
	tLB		2 min		Loading break time	48
	tRUN		15 min		Circulation runtime	48
	PSPEE		OFF		Pause speed option	51
	PDELA		OFF		Pump delay option	51
COOL >					Cooling functions	
	OSYC*		OFF		System cooling	51
	OSTC		OFF		Store cooling	52
	OHDP*		OFF		Heat dump	52
DT4 >					Heat exchange	
	DT4O		6 K		Switch-on difference	52
	DT4F		4 K		Switch-off difference	52
	DT4S		10 K		Set difference	53
	RIS4		2 K		Rise	53
	MAX4O		60 °C		Switch-on temperature (maximum limitation)	53
	MAX4F		58 °C		Switch-off temperature (maximum limitation)	53
	MIN4O		5 °C		Switch-on temperature (minimum limitation)	53
	MIN4F		10 °C		Switch-off temperature (minimum limitation)	53
OTH >					Thermostat function option	56
PUMP >					Speed	
	PUMP1		OnOF		Speed variant pump 1	45
	PUMP2		OnOF		Speed variant pump 2	45
	PUMP3		OnOF		Speed variant pump 3	45
MAN >					Manual mode	
	MAN1		Auto		Manual mode 1	56
	MAN2		Auto		Manual mode 2	56
	MAN3		Auto		Manual mode 3	56
	MAN4		Auto		Manual mode 4	56
BLPR >			OFF		Blocking protection	56
OTDIS >			OFF		Thermal disinfection option	57
OPARR >			OFF		Parallel relay option	58
OHQM >			OFF		Heat quantity measurement option	58
DATE >					Enter date	60
LANG >			dE		Language	61
UNIT >			°C		Unit	60
OSDC >					SD card option	61
CODE			0000		User code	64
RESET			OFF		Factory setting	

* are blocked against each other

System 3

2-store solar system with pump logic

The controller compares the temperature at sensor S1 to the temperatures at sensors S2 and S4. If the measured temperature differences are higher than the adjusted switch-on temperature differences, the

pump (R1 and/or R2) will be activated and the corresponding store will be loaded up to the adjusted maximum temperature at most.

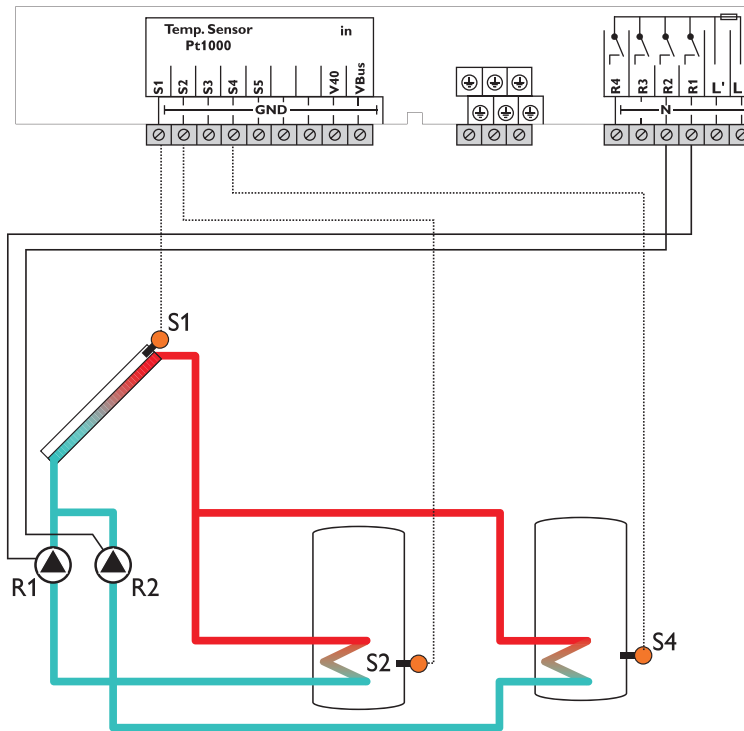
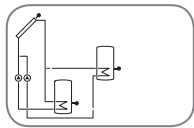

Sensor/terminal	Designation	Description
S1	TCOL	Temperature collector
S2	TST1B	Temperature store 1 base
S3		Optional sensor for measurement purposes or options
S4	TST2B	Temperature store 2 base
S5		Optional sensor for measurement purposes or options
V40		

Relay	Description
R1	Solar pump store 1
R2	Solar pump store 2
R3	optional:
R4	Thermal disinfection Parallel relay Heat dump

Adjustment channels

Channel	Sub channel 1	Sub channel 2	Factory setting	Change to	Description	Page
ARR			1	3	System	43
ROSA			0000	6	ROSA number	60
LOAD1 >					Loading 1	
	DT1O		6 K		Switch-on temperature difference 1	44
	DT1F		4 K		Switch-off temperature difference 1	44
	DT1S		10 K		Set temperature difference 1	44
	RIS1		2 K		Rise 1	44
	S1MAX		60 °C		Store maximum limitation 1	44
	SMXS1		2		Sensor store max 1	44
LOAD2 >					Loading 2	
	DT2O		6 K		Switch-on temperature difference 2	44
	DT2F		4 K		Switch-off temperature difference 2	44
	DT2S		10 K		Set temperature difference 2	44
	RIS2		2 K		Rise 2	44
	S2MAX		60 °C		Store maximum limitation 2	44
	SMXS2		4		Sensor store max 2	44
	LST2		ON		Loading store 2	45
COL >					Collector	
	CEM		130 °C		Collector emergency temperature	46
	OCCO*		OFF		Collector cooling option	46
		CMAX	110 °C		Collector maximum temperature	46
	OCMN		OFF		Collector minimum limitation option	46
		CMIN	10 °C		Minimum collector temperature	46
	OTCO		OFF		Tube collector function option	46
		TCST	07:00		Tube collector starting time	47
		TCEN	19:00		Tube collector ending time	47
		TCRU	30 s		Tube collector runtime	47
		TCIN	30 min		Tube collector standstill interval	47
	OCFR		OFF		Collector frost protection option	47
		CFR O	4 °C		Antifreeze temperature collector on	47
		CFR F	5 °C		Antifreeze temperature collector off	48
		FRPST	1		Antifreeze store selection	48
LLOGI >					Loading logic	
	LOGIC		PRIO		Priority logic	48
	PRIO1		1		Priority logic store 1	48

Adjustment channels						
Channel	Sub channel 1	Sub channel 2	Factory setting	Change to	Description	Page
	OSTS		OFF		Store set option	50
		TST1	45 °C		Set store temperature store 1	50
		TST2	45 °C		Set store temperature store 2	50
	OSE		OFF		Spread function option	50
		DTSE	20 K		Spread difference	50
		SLSTR	3		Store spread function	50
	tLB		2 min		Loading break time	48
	rRUN		15 min		Circulation runtime	48
	PSPEE		OFF		Pause speed option	51
	PDELA		OFF		Pump delay option	51
COOL >					Cooling functions	
	OSYC*		OFF		System cooling	51
	OSTC		OFF		Store cooling	52
	OHDP*		OFF		Heat dump	52
ODTFT >					ΔT function option	54
OTH >					Thermostat function option	56
PUMP >					Speed	
	PUMP1		OnOF		Speed variant pump 1	45
	PUMP2		OnOF		Speed variant pump 2	45
	PUMP3		OnOF		Speed variant pump 3	45
MAN >					Manual mode	
	MAN1		Auto		Manual mode 1	56
	MAN2		Auto		Manual mode 2	56
	MAN3		Auto		Manual mode 3	56
	MAN4		Auto		Manual mode 4	56
BLPR >			OFF		Blocking protection	56
OTDIS >			OFF		Thermal disinfection option	57
OPARR >			OFF		Parallel relay option	58
OHQM >			OFF		Heat quantity measurement option	58
DATE>					Enter date	60
LANG >			dE		Language	61
UNIT >			°C		Unit	60
OSDC >					SD card option	61
CODE			0000		User code	64
RESET			OFF		Factory setting	

* are blocked against each other

System 4

2-store solar system with pump logic and heat exchange control

The controller compares the temperature at sensor S1 to the temperatures at sensors S2 and S4. If the measured temperature differences are higher than the adjusted switch-on temperature differences, the pump

(R1 and/or R2) will be activated and the corresponding store will be loaded up to the adjusted maximum temperature. Store 1 is loaded with priority.

Heat exchange from store 2 to store 1 (R3) is possible with another temperature differential function (S3 - heat sink/S5 - heat source).

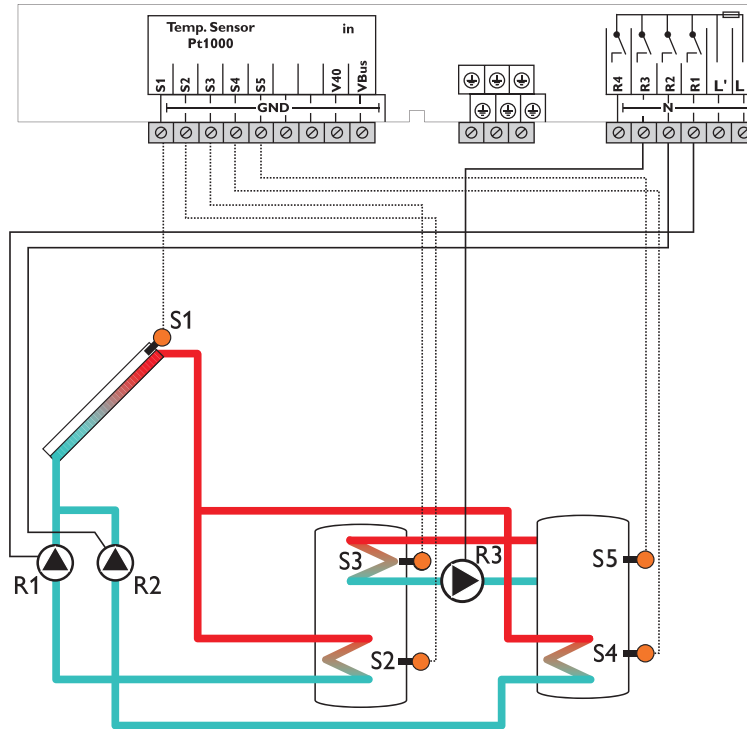
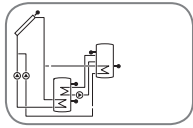

Sensor/terminal	Designation	Description
S1	TCOL	Temperature collector
S2	TST1B	Temperature store 1 base
S3	TST1T	Temperature store 1 top
S4	TST2B	Temperature store 2 base
S5	TST2T	Temperature store 2 top
V40		optional: flowmeter

Relay	Description
R1	Solar pump store 1
R2	Solar pump store 2
R3	Heat exchange pump
R4	optional: Thermal disinfection Parallel relay Heat dump

Adjustment channels

Channel	Sub channel 1	Sub channel 2	Factory setting	Change to	Description	Page
ARR			1	4	System	43
ROSA			0000	17	ROSA number	60
LOAD1 >					Loading 1	
	DT1O		6 K		Switch-on temperature difference 1	44
	DT1F		4 K		Switch-off temperature difference 1	44
	DT1S		10 K		Set temperature difference 1	44
	RIS1		2 K		Rise 1	44
	S1MAX		60 °C		Store maximum limitation 1	44
	SMXS1		2		Sensor store max 1	44
LOAD2 >					Loading 2	
	DT2O		6 K		Switch-on temperature difference 2	44
	DT2F		4 K		Switch-off temperature difference 2	44
	DT2S		10 K		Set temperature difference 2	44
	RIS2		2 K		Rise 2	44
	S2MAX		60 °C		Store maximum limitation 2	44
	SMXS2		4		Sensor store max 2	44
	LST2		ON		Loading store 2	45
COL >					Collector	
	CEM		130 °C		Collector emergency temperature	46
	OCCO*		OFF		Collector cooling option	46
		CMAX	110 °C		Collector maximum temperature	46
	OCMN		OFF		Collector minimum limitation option	46
		CMIN	10 °C		Minimum collector temperature	46
	OTCO		OFF		Tube collector function option	46
		TCST	07:00		Tube collector starting time	47
		TCEN	19:00		Tube collector ending time	47
		TCRU	30 s		Tube collector runtime	47
		TCIN	30 min		Tube collector standstill interval	47
	OCFR		OFF		Collector frost protection option	47
		CFR O	4 °C		Antifreeze temperature collector on	47
		CFR F	5 °C		Antifreeze temperature collector off	48
		FRPST	1		Antifreeze store selection	48
LOGI >					Loading logic	
	LOGIC		PRIO		Priority logic	48
	PRIO1		1		Priority logic store 1	48
	OSTS		OFF		Store set option	50
		TST1	45 °C		Set store temperature store 1	50
		TST2	45 °C		Set store temperature store 2	50
		OSE	OFF		Spread function option	50

Adjustment channels

Channel	Sub channel 1	Sub channel 2	Factory setting	Change to	Description	Page
		DTSE	20 K		Spread difference	50
		SLSTR	3		Spread function option	50
	tLB		2 min		Loading break time	48
	tRUN		15 min		Circulation runtime	48
	PSPEE		OFF		Pause speed option	51
COOL >					Cooling functions	
	OSYC*		OFF		System cooling	51
	OSTC		OFF		Store cooling	52
	OHDP*		OFF		Heat dump	52
DT4 >					Heat exchange	
	DT4O		6 K		Switch-on difference	52
	DT4F		4 K		Switch-off difference	52
	DT4S		10 K		Set difference	53
	RIS4		2 K		Rise	53
	MAX4O		60 °C		Switch-on temperature (maximum limitation)	53
	MAX4F		58 °C		Switch-off temperature (maximum limitation)	53
	MIN4O		5 °C		Switch-on temperature (minimum limitation)	53
	MIN4F		10 °C		Switch-off temperature (minimum limitation)	53
OTH					Thermostat function option	56
PUMP >					Speed	
	PUMP1		OnOF		Speed variant pump 1	45
	PUMP2		OnOF		Speed variant pump 2	45
	PUMP3		OnOF		Speed variant pump 3	45
MAN >					Manual mode	
	MAN1		Auto		Manual mode 1	56
	MAN2		Auto		Manual mode 2	56
	MAN3		Auto		Manual mode 3	56
	MAN4		Auto		Manual mode 4	56
BLPR >			OFF		Blocking protection	56
OTDIS >			OFF		Thermal disinfection option	57
OPARR >			OFF		Parallel relay option	58
OHQM >			OFF		Heat quantity measurement option	58
DATE>					Enter date	60
LANG >			dE		Language	61
UNIT >			°C		Unit	60
OSDC >					SD card option	61
CODE			0000		User code	64
RESET			OFF		Factory setting	

* are blocked against each other

System 5

3-store solar system with valve logic and priority logic

The controller compares the temperature at sensor S1 to the temperatures at sensors S2, S4 and S5. If the measured temperature differences are higher than the adjusted switch-on temperature differences,

the pump (R1) will be activated and the corresponding store will be loaded up to the adjusted maximum temperature via the valves (R3, R4). In this system, the desired store sequence can be adjusted. Depending

on the valve type used, the corresponding valve logic has to be selected.

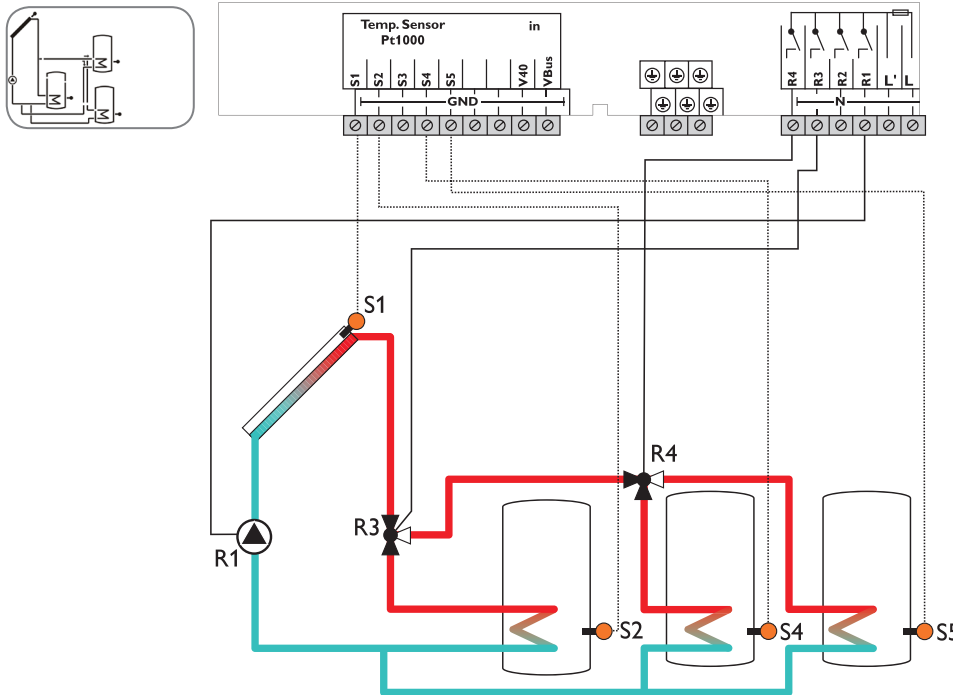

Sensor/terminal	Designation	Description
S1	TCOL	Temperature collector
S2	TST1B	Temperature store 1 base
S3		Optional sensor for measurement purposes or options
S4	TST2B	Temperature store 2 base
S5	TST3B	Temperature store 3 base
V40		Optional sensor for measurement purposes or options

Relay	Description
R1	Solar pump store 1
R2	
R3	Valve store 1/2, 3
R4	Valve store 2/3

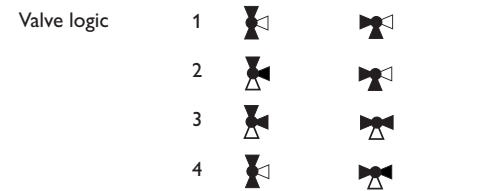

Flow direction when the valve is normally open

Adjustment channels

Channel	Sub channel 1	Sub channel 2	Factory setting	Change to	Description	Page
ARR			1	5	System	43
ROSA			0000	225	ROSA number	60
VLOG			1		Valve logic	60
LOAD1 >					Loading 1	
	DT1O		6 K		Switch-on temperature difference 1	44
	DT1F		4 K		Switch-off temperature difference 1	44
	DT1S		10 K		Set temperature difference 1	44
	RIS1		2 K		Rise 1	44
	S1MAX		60 °C		Store maximum limitation 1	44
	SMXS1		2		Sensor store max 1	44
LOAD2 >					Loading 2	
	DT2O		6 K		Switch-on temperature difference 2	44
	DT2F		4 K		Switch-off temperature difference 2	44
	DT2S		10 K		Set temperature difference 2	44
	RIS2		2 K		Rise 2	44
	S2MAX		60 °C		Sensor store max 2	44
	LST2		ON		Loading store 2	45
LOAD3					Loading 3	
	DT3O		6 K		Switch-on temperature difference 3	44
	DT3F		4 K		Switch-off temperature difference 3	44
	DT3S		10 K		Set temperature difference 3	44
	RIS3		2 K		Rise 3	44
	S3MAX		60 °C		Sensor store max 3	44
	LST3		ON		Loading store 3	45
COL >					Collector	
	CEM		130 °C		Collector emergency temperature	46
	OCCO*		OFF		Collector cooling option	46
		C MAX	110 °C		Collector maximum temperature	46
	O CMN		OFF		Collector minimum limitation option	46
		C MIN	10 °C		Minimum collector temperature	46
	OTCO		OFF		Tube collector function option	46
		TCST	07:00		Tube collector starting time	47
		TCEN	19:00		Tube collector ending time	47
		TCRU	30 s		Tube collector runtime	47
		TCIN	30 min		Tube collector standstill interval	47
	O CFR		OFF		Collector frost protection option	47
		CFR O	4 °C		Antifreeze temperature collector on	47

Adjustment channels

Channel	Sub channel 1	Sub channel 2	Factory setting	Change to	Description	Page
		CFR F	5 °C		Antifreeze temperature collector off	48
		FRPST	1		Antifreeze store selection	48
LLOGI >					Loading logic	
	LOGIC		PRIO		Priority logic	48
	PRIO1		1		Priority logic store 1	48
	OSTS		OFF		Store set option	50
		TST1	45 °C		Set store temperature store 1	50
		TST2	45 °C		Set store temperature store 2	50
		TST3	45 °C		Set store temperature store 3	50
	tLB		2 min		Loading break time	48
	tRUN		15 min		Circulation runtime	48
	PSPEE		OFF		Pause speed option	51
	PDELA		OFF		Pump delay option	51
COOL >					Cooling functions	
	OSYC*		OFF		System cooling	51
	OSTC		OFF		Store cooling	52
	OHDP*		OFF		Heat dump	52
OTH >					Thermostat function option	56
PUMP >					Speed	
	PUMP1		OnOF		Speed variant pump 1	45
	PUMP2		OnOF		Speed variant pump 2	45
	PUMP3		OnOF		Speed variant pump 3	45
MAN >					Manual mode	
	MAN1		Auto		Manual mode 1	56
	MAN2		Auto		Manual mode 2	56
	MAN3		Auto		Manual mode 3	56
	MAN4		Auto		Manual mode 4	56
BLPR >			OFF		Blocking protection	56
OTDIS >			OFF		Thermal disinfection option	57
OPARR >			OFF		Parallel relay option	58
OHQM >			OFF		Heat quantity measurement option	58
DATE >					Enter date	60
LANG >			dE		Language	61
UNIT >			°C		Unit	60
OSDC >					SD card option	61
CODE			0000		User code	64
RESET			OFF		Factory setting	

* are blocked against each other

System 6

3-store solar system with pump logic and priority logic

The controller compares the temperature at sensor S1 to the temperatures at sensors S2, S4 and S5. If the measured temperature differences are higher than the adjusted switch-on temperature differences, the

pump (R1, R2 and/or R3) will be activated and the corresponding store will be loaded up to the adjusted maximum temperature at most. Priority loading or parallel loading can be carried out in this system.

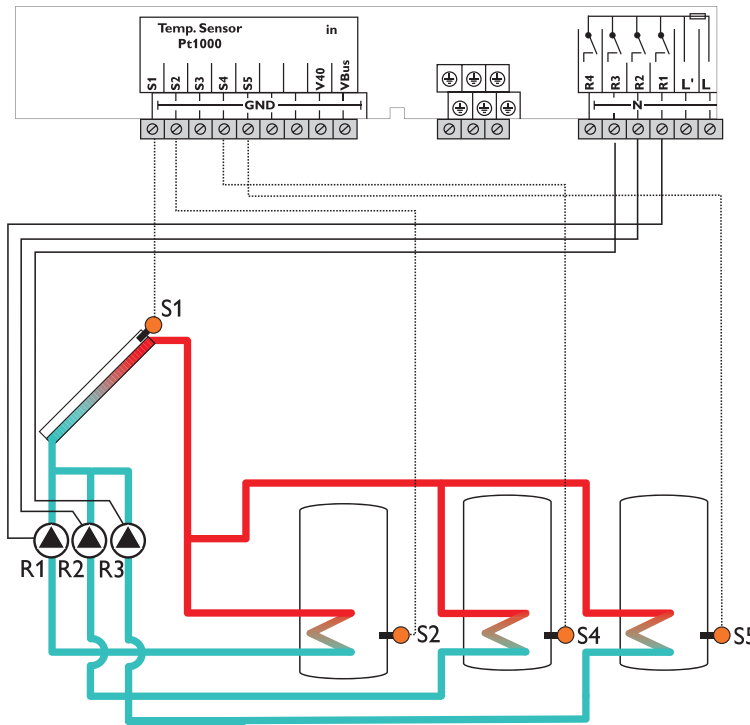
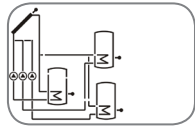

Sensor/terminal	Designation	Description
S1	TCOL	Temperature collector
S2	TST1B	Temperature store 1 base
S3		Optional sensor for measurement purposes or options
S4	TST2B	Temperature store 2 base
S5	TST3B	Temperature store 3 base
V40		Optional sensor for measurement purposes or options

Relay	Description
R1	Solar pump store 1
R2	Solar pump store 2
R3	Solar pump store 3
R4	optional: Thermal disinfection Parallel relay Heat dump

Adjustment channels						
Channel	Sub channel 1	Sub channel 2	Factory setting	Change to	Description	Page
ARR			1	6	System	43
ROSA			0000	226	ROSA number	60
LOAD1 >					Loading 1	
	DT1O		6 K		Switch-on temperature difference 1	44
	DT1F		4 K		Switch-off temperature difference 1	44
	DT1S		10 K		Set temperature difference 1	44
	RIS1		2 K		Rise 1	44
	S1MAX		60 °C		Store maximum limitation 1	44
	SMXS1		2		Sensor store max 1	44
LOAD2 >					Loading 2	
	DT2O		6 K		Switch-on temperature difference 2	44
	DT2F		4 K		Switch-off temperature difference 2	44
	DT2S		10 K		Set temperature difference 2	44
	RIS2		2 K		Rise 2	44
	S2MAX		60 °C		Store maximum limitation 2	44
	LST2		ON		Loading store 2	45
LOAD3 >					Loading 3	
	DT3O		6 K		Switch-on temperature difference 3	44
	DT3F		4 K		Switch-off temperature difference 3	44
	DT3S		10 K		Set temperature difference 3	44
	RIS3		2 K		Rise 3	44
	S3MAX		60 °C		Store maximum limitation 3	44
	LST3		ON		Loading store 3	45
COL >					Collector	
	CEM		130 °C		Collector emergency temperature	46
	OCCO*		OFF		Collector cooling option	46
		CMAX	110 °C		Collector maximum temperature	46
	OCMN		OFF		Collector minimum limitation option	46
		CMIN	10 °C		Minimum collector temperature	46
	OTCO		OFF		Tube collector function option	46
		TCST	07:00		Tube collector starting time	47
		TCEN	19:00		Tube collector ending time	47
		TCRU	30 s		Tube collector runtime	47
		TCIN	30 min		Tube collector standstill interval	47
	OCFR		OFF		Collector frost protection option	47
		CFR O	4 °C		Antifreeze temperature collector on	47
		CFR F	5 °C		Antifreeze temperature collector off	48
		FRPST	1		Antifreeze store selection	48
LLOGI >					Loading logic	

Adjustment channels

Channel	Sub channel 1	Sub channel 2	Factory setting	Change to	Description	Page
	LOGIC		PRIO		Priority logic	48
	PRIO1		1		Priority logic store 1	48
	PRIO2		2		Priority logic store 2	48
	OSTS		OFF		Store set option	50
		TST1	45 °C		Set store temperature store 1	50
		TST2	45 °C		Set store temperature store 2	50
		TSTS3	45 °C		Set store temperature store 3	50
	OSE		OFF		Spread function option	50
		DTSE	20 K		Spread difference	50
		SLSTR	1		Reference store	50
		SLSTA	2		Absorption store	50
	tLB		2 min		Loading break time	48
	tRUN		15 min		Circulation runtime	48
	PSPEE		OFF		Pause speed option	51
COOL >					Cooling functions	
	OSYC*		OFF		System cooling	51
	OSTC		OFF		Store cooling	52
	OHDP*		OFF		Heat dump	52
OTH >					Thermostat function option	56
PUMP >					Speed	
	PUMP1		OnOF		Speed variant pump 1	45
	PUMP2		OnOF		Speed variant pump 2	45
	PUMP3		OnOF		Speed variant pump 3	45
MAN >					Manual mode	
	MAN1		Auto		Manual mode 1	56
	MAN2		Auto		Manual mode 2	56
	MAN3		Auto		Manual mode 3	56
	MAN4		Auto		Manual mode 4	56
BLPR >			OFF		Blocking protection	56
OTDIS >			OFF		Thermal disinfection option	57
OPARR >			OFF		Parallel relay option	58
OHQM >			OFF		Heat quantity measurement option	58
DATE >					Enter date	60
LANG >			dE		Language	61
UNIT >			°C		Unit	60
OSDC >					SD card option	61
CODE			0000		User code	64
RESET			OFF		Factory setting	

* are blocked against each other

System 7

Solar system with store loading in layers and 2nd store

The controller compares the temperature at sensor S1 to the temperatures at sensors S2, S3 and S4. If the measured temperature differences are higher than the adjusted switch-on temperature differences, the pump (R1) will be activated (see speed control) and the cor-

responding store or store zone will be loaded up to the adjusted maximum temperature via the valves (R3, R4). Depending on the valve type used, the corresponding valve logic has to be selected.

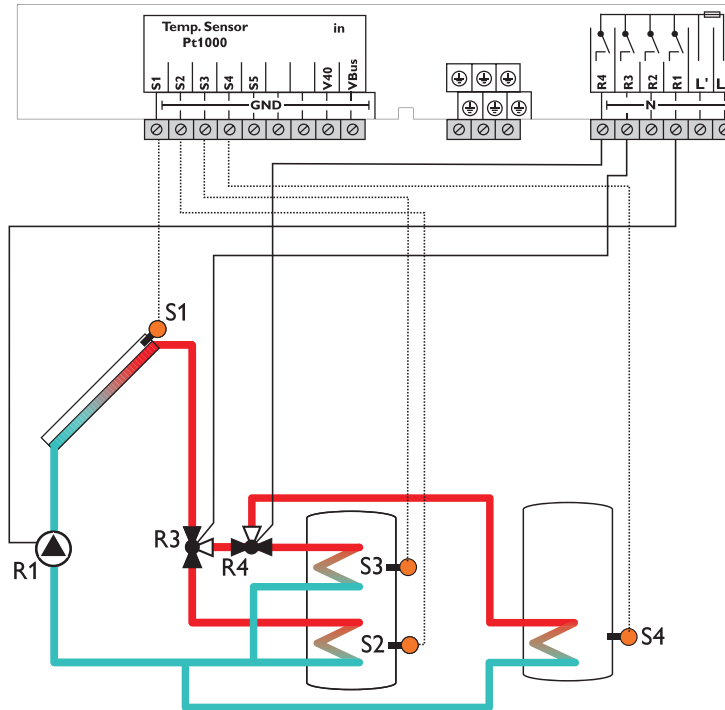
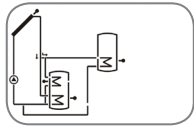

Note

A solar system with store loading in layers is implemented as a 2-store system. (store base = store 1; store top = store 2; additional store = store 3)

Sensor/terminal	Designation	Description
S1	TCOL	Temperature collector
S2	TST1B	Temperature store 1 base (store 1)
S3	TST1T	Temperature store 1 top (store 2)
S4	TST3B	Temperature store 2 base (store 3)
S5		Optional sensor for measurement purposes or options
V40		

Relay	Description
R1	Solar pump store 1
R2	optional: Thermal disinfection Parallel relay Heat dump
R3	Valve store 1, 2/3
R4	Valve store 2/3

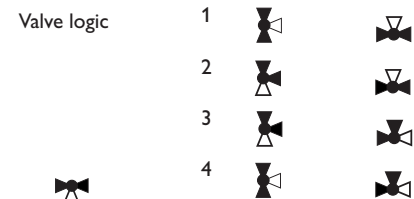

Flow direction when the valve is normally open

Adjustment channels

Channel	Sub channel 1	Sub channel 2	Factory setting	Change to	Description	Page
ARR			1	7	System	43
ROSA			0000	227	ROSA number	60
VLOG			1		Valve logic	
LOAD1 >					Loading 1	
	DT1O		6 K		Switch-on temperature difference 1	44
	DT1F		4 K		Switch-off temperature difference 1	44
	DT1S		10 K		Set temperature difference 1	44
	RIS1		2 K		Rise 1	44
	S1MAX		60 °C		Store maximum limitation 1	44
	SMXS1		2		Sensor store max 1	44
LOAD2 >					Loading 2	
	DT2O		6 K		Switch-on temperature difference 2	44
	DT2F		4 K		Switch-off temperature difference 2	44
	DT2S		10 K		Set temperature difference 2	44
	RIS2		2 K		Rise 2	44
	S2MAX		60 °C		Store maximum limitation 2	44
	LST2		ON		Loading store 2	45
LOAD3 >						
	DT3O		6 K		Switch-on temperature difference 3	44
	DT3F		4 K		Switch-off temperature difference 3	44
	DT3S		10 K		Set temperature difference 3	44
	RIS3		2 K		Rise 3	44
	S3MAX		60 °C		Store maximum limitation 3	44
	SMXS3		4		Sensor store max 3	44
	LST3		ON		Loading store 3	45
COL >					Collector	
	CEM		130 °C		Collector emergency temperature	46
	OCCO*		OFF		Collector cooling option	46
		C MAX	110 °C		Collector maximum temperature	46
	OCMN		OFF		Collector minimum limitation option	46
		C MIN	10 °C		Minimum collector temperature	46
	OTCO		OFF		Tube collector function option	46
		TCST	07:00		Tube collector starting time	47
		TCEN	19:00		Tube collector ending time	47
		TCRU	30 s		Tube collector runtime	47
		TCIN	30 min		Tube collector standstill interval	47
	O CFR		OFF		Collector frost protection option	47
		CFR O	4 °C		Antifreeze temperature collector on	47

Adjustment channels

Channel	Sub channel 1	Sub channel 2	Factory setting	Change to	Description	Page
		CFR F	5 °C		Antifreeze temperature collector off	48
		FRPST	1		Antifreeze store selection	48
LLOGI >					Loading logic	
	LOGIC		PRIO		Priority logic	48
	PRIO1		2		Priority logic store 1	48
	PRIO2		1		Priority logic store 2	48
	OSTS		OFF		Store set option	50
		TST1	45 °C		Set store temperature store 1	50
		TST2	45 °C		Set store temperature store 2	50
		TSTS3	45 °C		Set store temperature store 3	50
	tLB		2 min		Loading break time	48
	tRUN		15 min		Circulation runtime	48
	PSPEE		OFF		Pause speed option	51
	PDELA		OFF		Pump delay option	51
COOL >					Cooling functions	
	OSYC*		OFF		System cooling	51
	OSTC		OFF		Store cooling	52
	OHDP*		OFF		Heat dump	52
OTH >					Thermostat function option	56
PUMP >					Speed	
	PUMP1		OnOF		Speed variant pump 1	45
	PUMP2		OnOF		Speed variant pump 2	45
	PUMP3		OnOF		Speed variant pump 3	45
MAN >					Manual mode	
	MAN1		Auto		Manual mode 1	56
	MAN2		Auto		Manual mode 2	56
	MAN3		Auto		Manual mode 3	56
	MAN4		Auto		Manual mode 4	56
BLPR >			OFF		Blocking protection	56
OTDIS >			OFF		Thermal disinfection option	57
OPARR >			OFF		Parallel relay option	58
OHQM >			OFF		Heat quantity measurement option	58
DATE >					Enter date	60
LANG >			dE		Language	61
UNIT >			°C		Unit	60
OSDC >					SD card option	61
CODE			0000		User code	64
RESET			OFF		Factory setting	

* are blocked against each other

System 8

Solar system with east-/west collectors and 2 stores (valve logic)

The controller compares the temperatures at the collector sensors S1 and S3 to the temperatures at S2 and S4. If one of the measured temperature differ-

ences is higher than the adjusted switch-on temperature differences, the corresponding pump (R1, R2) or both pumps will be activated and the corresponding store

will be loaded up to the adjusted maximum temperature via the valve (R3).

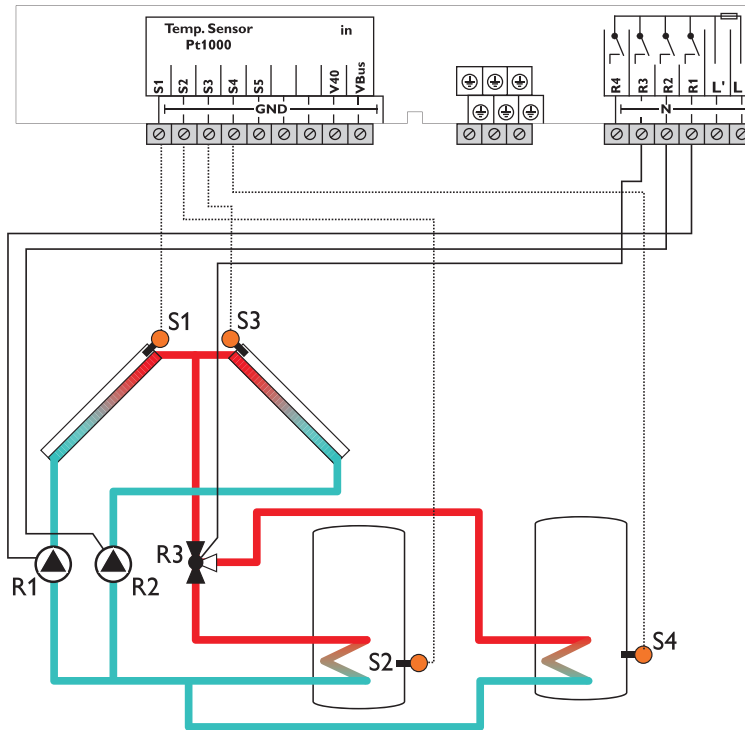
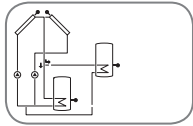

Note: 3-port valve normally open - store 1 (S2)

Sensor/terminal	Designation	Description
S1	TCOL1	Temperature collector 1
S2	TST1B	Temperature store 1 base
S3	TCOL2	Temperature collector 2
S4	TST2B	Temperature store 2 base
S5		Optional sensor for measurement purposes or options
V40		

Relay	Description
R1	Solar pump collector 1
R2	Solar pump collector 2
R3	3-port valve store 1/2
R4	optional: Thermal disinfection Parallel relay Heat dump

Adjustment channels

Channel	Sub channel 1	Sub channel 2	Factory setting	Change to	Description	Page
ARR			1	23	System	43
ROSA			0000	29	ROSA number	
LOAD1 >					Loading 1	
	DT1O		6 K		Switch-on temperature difference 1	43
	DT1F		4 K		Switch-off temperature difference 1	43
	DT1S		10 K		Set temperature difference 1	43
	RIS1		2 K		Rise 1	43
	S1MAX		60 °C		Store maximum limitation 1	44
	SMXS1		2		Sensor store max 1	44
LOAD2 >					Loading 2	
	DT2O		6 K		Switch-on temperature difference 2	43
	DT2F		4 K		Switch-off temperature difference 2	44
	DT2S		10 K		Set temperature difference 2	44
	RIS2		2 K		Rise 2	44
	S2MAX		60 °C		Store maximum limitation 2	44
	SMXS2		4		Sensor store max 2	44
	LST2		ON		Loading store 2	45
COL 1 >					Collector 1	
	CEM1		130 °C		Collector emergency temperature 1	46
	OCCO1*		OFF		Collector cooling option 1	46
		CMAX1	110 °C		Maximum collector temperature 1	46
	OCCI1		OFF		Collector minimum limitation option 1	46
		CMIN1	10 °C		Minimum collector temperature 1	46
	OTCO1		OFF		Tube collector function option 1	46
		TCST1	07:00		Tube collector starting time 1	47
		TCEN1	19:00		Tube collector ending time 1	47
		TCRU1	30 s		Tube collector runtime 1	47
		TCIN1	30 min		Tube collector standstill interval 1	47
	O CFR		OFF		Collector frost protection option	47
		CFR O	4 °C		Antifreeze temperature collector on	47
		CFR F	5 °C		Antifreeze temperature collector off	47
		FRPST	1		Antifreeze store selection	47
COL 2 >					Collector 2	
	CEM2		130 °C		Collector emergency temperature 2	46
	OCCO2*		OFF		Collector cooling option 2	46
		CMAX2	110 °C		Maximum collector temperature 2	46
	OCCI2		OFF		Collector minimum limitation option 2	46
		CMIN2	10 °C		Minimum collector temperature 2	46
	OTCO2		OFF		Tube collector function option 2	46
		TCST2	07:00		Tube collector starting time 2	46

Adjustment channels

Channel	Sub channel 1	Sub channel 2	Factory setting	Change to	Description	Page
		TCEN2	19:00		Tube collector ending time 2	46
		TCRU2	30 s		Tube collector runtime 2	46
		TCIN2	30 min		Tube collector standstill interval 2	46
LLOGI >					Loading logic	
	LOGIC		PRIO		Priority logic	48
	PRIO1		1		Priority logic store 1	48
	OSTS		OFF		Store set option	48
		TST1	45 °C		Set store temperature store 1	48
		TST2	45 °C		Set store temperature store 2	48
	tLB		2 min		Loading break time	48
	tRUN		15 min		Circulation runtime	48
	PSPEE		OFF		Pause speed option	51
	PDELA		OFF		Pump delay option	51
COOL >					Cooling functions	
	OSYC*		OFF		System cooling	51
	OSTC		OFF		Store cooling	51
	OHDP*		OFF		Heat dump	51
OTH >					Thermostat function option	56
PUMP >					Speed	
	PUMP1		OnOF		Speed variant pump 1	45
	PUMP2		OnOF		Speed variant pump 2	45
	PUMP3		OnOF		Speed variant pump 3	45
MAN >					Manual mode	
	MAN1		Auto		Manual mode 1	56
	MAN2		Auto		Manual mode 2	56
	MAN3		Auto		Manual mode 3	56
	MAN4		Auto		Manual mode 4	56
BLPR >			OFF		Blocking protection	56
OTDIS >			OFF		Thermal disinfection option	57
OPARR >			OFF		Parallel relay option	58
OHQM >			OFF		Heat quantity measurement option	58
DATE >					Enter date	58
LANG >			dE		Language	61
UNIT >			°C		Unit	60
OSDC >					SD card option	61
CODE			0000		User code	64
RESET			OFF		Factory setting	

* are blocked against each other

System 9

3-store solar system with east-/west collectors

The controller compares the temperatures at the collector sensors S1 and S3 to the store temperatures at the sensors S2, S4 and S5. If one of the measured

temperature differences is higher than the adjusted switch-on temperature differences, the corresponding pump (R1, R2) will be activated and the correspond-

ing store will be loaded up to the adjusted maximum temperature via the valves R3, R4. In this system, one of the stores can be loaded with priority.

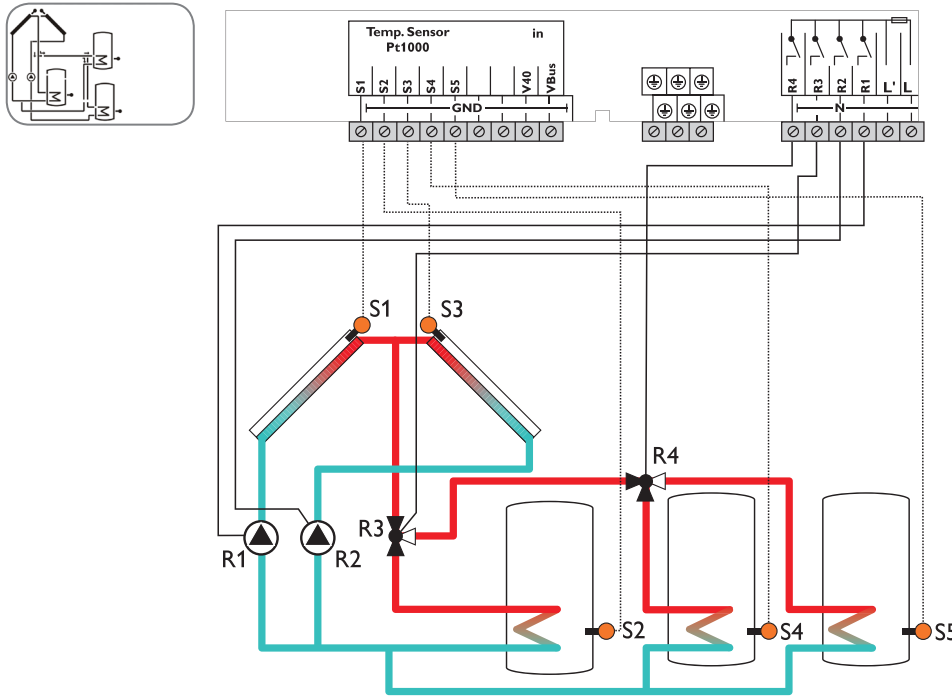

Sensor/terminal	Designation	Description
S1	TCOL	Temperature collector 1
S2	TST1B	Temperature store 1 base
S3	TCOL2	Temperature collector 2
S4	TST2B	Temperature store 2 base
S5	TST3B	Temperature store 3 base
V40		optional: flowmeter

Relay	Description
R1	Solar pump store 1
R2	Solar pump store 2
R3	Valve store 1/2, 3
R4	Valve store 2/3

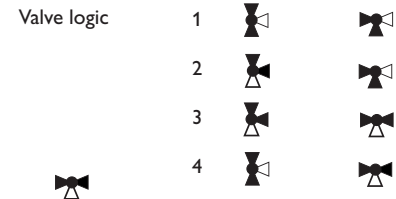

Flow direction when the valve is normally open

Adjustment channels						
Channel	Sub channel 1	Sub channel 2	Factory setting	Change to	Description	Page
ARR			1	9	System	43
ROSA			0000	228	ROSA number	60
VLOG			1		Valve logic	
LOAD1 >					Loading 1	
	DT1O		6 K		Switch-on temperature difference 1	44
	DT1F		4 K		Switch-off temperature difference 1	44
	DT1S		10 K		Set temperature difference 1	44
	RIS1		2 K		Rise 1	44
	S1MAX		60 °C		Store maximum limitation 1	44
LOAD2 >					Loading 2	
	DT2O		6 K		Switch-on temperature difference 2	44
	DT2F		4 K		Switch-off temperature difference 2	44
	DT2S		10 K		Set temperature difference 2	44
	RIS2		2 K		Rise 2	44
	S2MAX		60 °C		Store maximum limitation 2	44
	LST2		ON		Loading store 2	45
LOAD3 >					Loading 2	
	DT3O		6 K		Switch-on temperature difference 3	44
	DT3F		4 K		Switch-off temperature difference 3	44
	DT3S		10 K		Set temperature difference 3	44
	RIS3		2 K		Rise 3	44
	LST3		ON		Loading store 3	45
COL 1 >					Collector	
	CEM		130 °C		Collector emergency temperature	46
	OCCO*		OFF		Collector cooling option	46
	OCMN	CMAX	110 °C		Collector maximum temperature	46
			OFF		Collector minimum limitation option	46
		CMIN	10 °C		Minimum collector temperature	46
	OTCO		OFF		Tube collector function option	46
		TCST	07:00		Tube collector starting time	47
		TCEN	19:00		Tube collector ending time	47
		TCRU	30 s		Tube collector runtime	47
		TCIN	30 min		Tube collector standstill interval	47
	O CFR		OFF		Collector frost protection option	47
		CFR O	4 °C		Antifreeze temperature collector on	47
		CFR F	5 °C		Antifreeze temperature collector off	48
		FRPST	1		Antifreeze store selection	48
COL 2 >					Collector 2	
	CEM2		130 °C		Collector emergency temperature 2	46
	OCCO2*		OFF		Collector cooling option 2	46
		C MAX2	110 °C		Maximum collector temperature 2	46

Adjustment channels						
Channel	Sub channel 1	Sub channel 2	Factory setting	Change to	Description	Page
	OCMI2		OFF		Collector minimum limitation option 2	46
		CMIN2	10 °C		Minimum collector temperature 2	46
	OTCO2		OFF		Tube collector function option 2	46
		TCST2	07:00		Tube collector starting time 2	46
		TCEN2	19:00		Tube collector ending time 2	46
		TCRU2	30 s		Tube collector runtime 2	46
		TCIN2	30 min		Tube collector standstill interval 2	46
LLOGI >					Loading logic	
	LOGIC		PRIO		Priority logic	48
	PRIO1		1		Priority logic store 1	48
	PRIO2		2		Priority logic store 2	48
	OSTS		OFF		Store set option	50
		TST1	45 °C		Set store temperature store 1	50
		TST2	45 °C		Set store temperature store 2	50
		TSTS3	45 °C		Set store temperature store 3	50
	tLB		2 min		Loading break time	48
	tRUN		15 min		Circulation runtime	48
	PSPEE		OFF		Pause speed option	51
	PDELA		OFF		Pump delay option	51
COOL >					Cooling functions	
	OSYC*		OFF		System cooling	51
	OSTC		OFF		Store cooling	52
PUMP >					Speed	
	PUMP1		OnOF		Speed variant pump 1	45
	PUMP2		OnOF		Speed variant pump 2	45
	PUMP3		OnOF		Speed variant pump 3	45
MAN >					Manual mode	
	MAN1		Auto		Manual mode 1	56
	MAN2		Auto		Manual mode 2	56
	MAN3		Auto		Manual mode 3	56
	MAN4		Auto		Manual mode 4	56
BLPR >			OFF		Blocking protection	56
OHQM >			OFF		Heat quantity measurement option	58
DATE >					Enter date	60
LANG >			dE		Language	61
UNIT >			°C		Unit	60
OSDC >					SD card option	61
CODE			0000		User code	
RESET			OFF		Factory setting	

* are blocked against each other

Electrical connection of a high-efficiency pump (HE pump)

Speed control of a HE pump is possible via a PWM signal. In addition to the relay connection, the pump must also be connected to the controller via the VBus®/PWM interface adapter. In the PUMP adjustment channel, ADAP has to be selected.

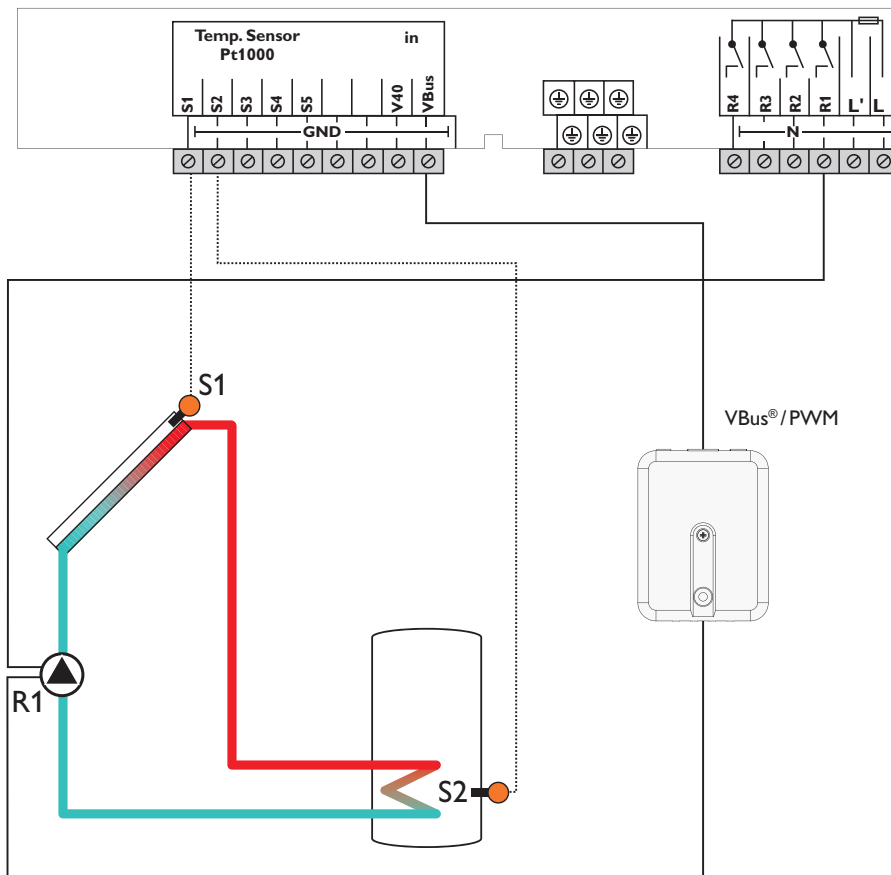

3 Operation and function

3.1 Buttons

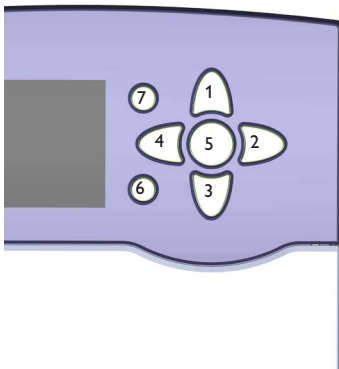

The controller is operated via the 7 buttons next to the display. They have the following functions:

- Button - scrolling upwards
- Button - scrolling downwards
- Button - increasing adjustment values
- Button - reducing adjustment values
- Button - confirming
- Button - menu button for changing between the status and the menu level
- Button - escape button for changing into the previous menu

3.2 Selecting menu points and adjusting values

During normal operation of the controller, the display is in the status level.

In order to leave the status level and access the menu level, press button 6.

The display indicates the level with the selectable menu. In order to change the parameters of a menu item, select the menu item and press button 5. The display changes to the adjustment level. The adjustment channels are characterised by the indication

SET

- Select the desired channel by pressing the buttons and
- Confirm the selection with button , **SET** starts flashing (adjustment mode)
- Adjust the value, the function or the option using the buttons and
- Confirm the selection with button , **SET** permanently appears, the adjustment has been saved.

If no button has been pressed within a couple of minutes, the adjustment is cancelled and the previous value is retained.

3.3 Menu structure

Status level

TCOL
TST1B
...

Menu level

ARR
LOAD1
LOAD2
LOAD3
COL
COL1
COL2
LLOGI
...

Adjustment level

DT O
DT F
DT S
RIS
S MAX
SMXS
...

The menu structure of the controller consists of 3 levels: the status level, the menu level and the adjustment level.

The status level consists of different display channels which indicate display values and messages.

The menu level consists of different menu items each of which is divided into sub-menus and adjustment channels. Each of these menu items represents a function or option which can be selected. If a function or option is selected, the controller changes to the adjustment level in which the corresponding parameters of the function or option are available.

In order to activate or deactivate a function, it must be selected in the menu level. The display changes to the adjustment menu in which all adjustments required can be carried out.

During normal operation of the controller, the display is in the status level.



Note

Some of the menu items depend on the selected system and the adjusted options. Therefore, they are only displayed if they are available.



Note

The abstract from the menu structure shown page 35 is for information on the structure of the controller menu and is therefore not complete.

Menu level

If it is possible to jump into a sub-level, **PUSH** is indicated below the menu item. Use button (5) to access the menu. In order to leave the menu, press button (7).

If an option is deactivated, it will appear in the menu level with the addition **OFF**.

3.4 Shortcut

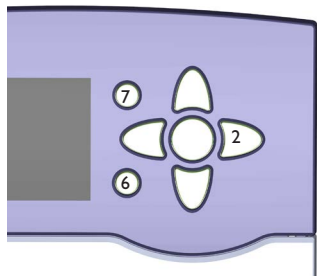

The controller is equipped with a shortcut that enables a quick access to the **MAN** menu (manual mode).

→ In order to access the **MAN** menu, press buttons (6) and (7) at the same time, then press button (2).

3.5 Indications and system monitoring display

The system monitoring display consists of 3 areas: channel display, tool bar and system screen.

Channel display



The channel display consists of 2 lines. The upper display line is an alphanumeric 16-segment display. In this line, mainly channel names and menu items are displayed. In the lower 7-segment display, channel values and the adjustment parameters are displayed.

Temperatures and temperature differences are indicated with the unit (°C/°F or K/°R respectively).

Tool bar



The additional symbols in the tool bar indicate the current system state.

Symbol	normal	flashing
	Relay active	
	Maximum store limitation active/maximum store temperature exceeded	Collector cooling function active System cooling, store cooling active
	Antifreeze function activated	Collector minimum limitation active Antifreeze function active
		Collector emergency shutdown
		Sensor fault
		Manual mode active
		Store emergency shutdown active
		Adjustment channel is being changed (set mode)
	SD card is being used	SD card is full
	Indication of the buttons available in the menu item	
	Normal operation	

System screen in the system monitoring display

The system selected is indicated in the system monitoring display. It consists of several system component symbols which are – depending on the current status of the system – either flashing, permanently shown or “hidden”.

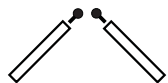
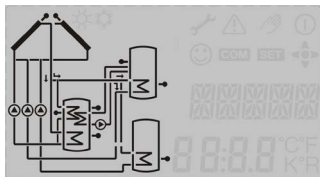

Collectors with collector sensor

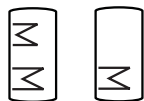

Stores 1, 2 and 3 with heat exchanger



3-port valves
Only the flow direction or current switching position are indicated.



Temperature sensor



Pump

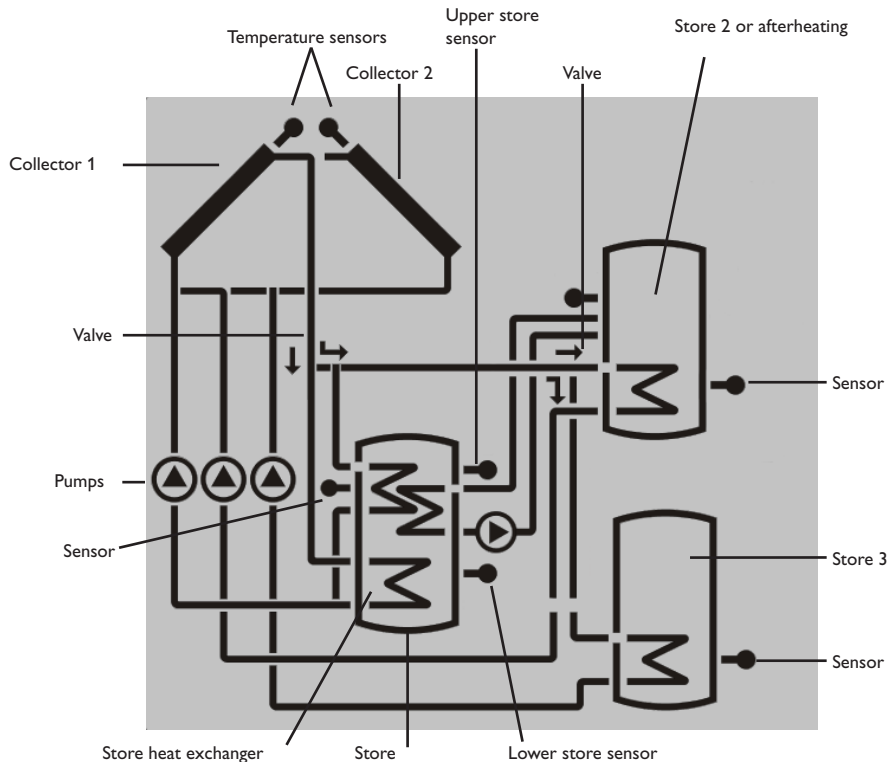

3.6 Further indications

Fault indication

If the controller detects a malfunction, the directional pad flashes red and the symbols of the warning triangle and the wrench are additionally displayed.

Smiley

If the controller operates faultlessly (normal operation), a smiley is displayed.

4 Status menu

During normal operation of the controller, the display is in the status level. This one indicates the measurement values shown in the table.

In addition to the display values, possible error messages are indicated in the status menu (see page 64).

Display	Description
S5	Temperature sensor 5
DTS1	Temperature heat source ΔT function
DTS2	Temperature heat sink ΔT function
SENTH	Temperature thermostat function
TFHQM	Temperature flow heat quantity measurement
TRHQM	Temperature return heat quantity measurement
n1 %	Speed relay 1
n2 %	Speed relay 2
n3 %	Speed relay 3
h R1	Operating hours relay 1
h R2	Operating hours relay 2
h R3	Operating hours relay 3
h R4	Operating hours relay 4
L/h	Flow rate
kWh	Heat quantity in kWh
MWh	Heat quantity in MWh
TDIS	Temperature thermal disinfection
CDIS	Countdown of monitoring period (thermal disinfection)
DDIS	Countdown of heating period (thermal disinfection)
TIME	Time
DATE	Date

Display	Description
BLPR1	Blocking protection R1
BLPR2	Blocking protection R2
BLPR3	Blocking protection R3
BLPR4	Blocking protection R4
DTFCT	Differential function active
THERM	Thermostat function active
TCOL	Temperature collector
TCOL1	Temperature collector 1
TST1B	Temperature store 1 base
TSTT	Temperature store top
S3	Temperature sensor 3
TST2B	Temperature store 2 base
TST3B	Temperature store 3 base
TST2T	Temperature store 2 top
S4	Temperature sensor 4
TCOL2	Temperature collector 2

5 Initial commissioning

When the hydraulic system is filled and ready for operation, connect the controller to the mains.

The controller runs an initialisation phase in which all symbols are indicated in the display. The directional pad flashes red.

When the controller is commissioned for the first time or when it is reset, it will run a commissioning menu after the initialisation phase. The commissioning menu leads the user through the most important adjustment channels needed for operating the system and starts with the indication of the BX L version number.

Commissioning menu

The commissioning menu consists of the channels described in the following. In order to make an adjustment, push button **5**. The set symbol flashes and the adjustment can be made. Confirm the adjustment with button **5**. Push button **3**, the next channel will appear in the display.

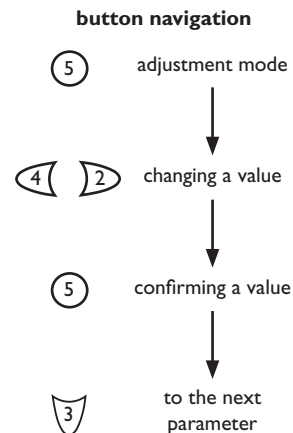

1. Language:

→ Adjust the desired menu language.

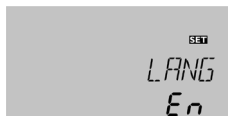

2. Unit:

→ Adjust the desired unit.



3. Time:

→ Adjust the clock time. First of all adjust the hours, then the minutes.

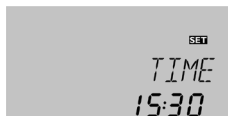

4. Date:

→ Adjust the date. First of all adjust the year, then the month and then the day.

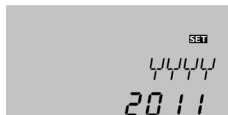

5. System:

→ Adjust the desired system.



6. ROSA:

→ Enter the 4-digit number given by the RESOL On-line Service Assistant.



Note

If the desired system layout has been selected in the ARR channel, the ROSA channel can be skipped.

7. Valve logic:

- Adjust the valve variant of the 3-port valves

8. Maximum store temperature:

- Adjust the maximum store temperature
In 3-store systems, the adjustment has to be carried out for **S2MAX** and **S3MAX** as well.



9. Loading store 2 and store 3

- Switch on or off the “loading store 2”/“loading store 3” option.

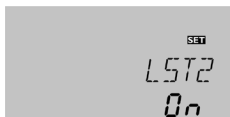

10. Pump control type:

- Adjust the type of pump control for **PUMP1**.
Carry out this adjustment for PUMP2, PUMP3 if needed.



11. Minimum speed:

- Adjust the minimum speed of the pump PUMP1.
For systems with 3 pumps, the adjustments must also be carried out for PUMP2, PUMP3



12. Maximum speed:

- Adjust the maximum speed of the pump PUMP1.
For systems with 2 or 3 pumps, the adjustments must also be made for PUMP2, PUMP3.



- **Complete the commissioning menu by pressing button 5:**

The controller is then ready for operation and normally the factory settings will give close to optimum operation.



Note

The valve variant can only be adjusted in systems with two 3-port valves (ARR 5,7,9).



Note

“Loading store 3” can only be adjusted if a 3-store system or store loading in layers has been selected in the sub-channel **ARR**.



Note

The minimum speed can only be adjusted if burst control (PULS) or speed control via an adapter (ADAP) has been selected in the sub-channel **PUMP1,2,3**.



Note

The maximum speed can only be adjusted if burst control (PULS) or speed control via an adapter (ADAP) has been selected in the sub-channel **PUMP1,2,3**.

6 Functions and options

6.1 Status level



Note

The values and adjustment channels shown depend on the selected system, the functions and options and will only be displayed in the expert level.

Display of collector temperatures



TCOL(1, 2)

Collector temperature

Display range: -40 ... +260 °C

Displays the current collector temperature.

- TCOL : Collector temperature (1-collector system)
- TCOL1 : Collector temperature 1 (2-collector system)
- TCOL2 : Collector temperature 2 (2-collector system)

Display of store temperatures

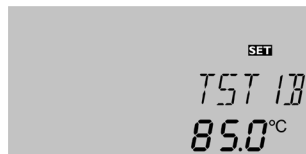

TST1 (2, 3)B, TST1 (2)T

Store temperatures

Display range: -40 ... +260 °C

Displays the current store temperature.

- TST1T : Temperature store 1 top
- TST1B : Temperature store 1 base
- TST2T : Temperature store 2 top
- TST2B : Temperature store 2 base

in 3-store systems only:

- TST3B : Temperature store 3 base

Display of temperatures at S3, S4 and S5

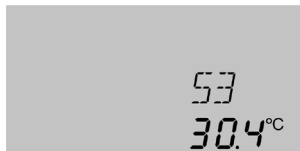

S3, S4, S5

Sensor temperatures

Display range: -40 ... +260 °C

Indicates the current temperature at the corresponding additional sensor (without control function).

- S3 : Temperature sensor 3
- S4 : Temperature sensor 4
- S5 : Temperature sensor 5



Note

Only if temperature sensors are connected, will S3, S4 and S5 be displayed.



Note

For heat exchange etc., S3/S5 are used as heat source/heat sink sensor respectively.

Display of further temperatures

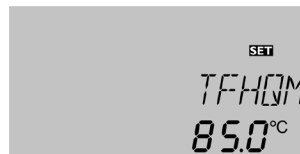

DTS1, DTS2, SENTH,

TFHQM, TRHQM

Further measured temperatures

Display range: -40 ... +260 °C

Indicates the current temperature at the corresponding sensor. The display of these temperatures depends on the system selected.

- DTS1 : Temperature heat source ΔT function
- DTS2 : Temperature heat sink ΔT function
- SENTH : Temperature thermostat function
- TFHQM : Temperature flow (HQM)
- TRHQM : Temperature return (HQM)

Display of flow rate

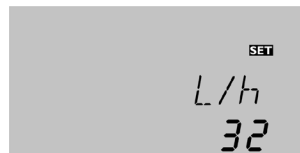

L/h

Flow rate

Display range: 0 ... 9999 l/h

Indicates the flow rate in the solar system during heat quantity measurement.

During heat quantity balancing, the fixed flow rate value adjusted is indicated.

Display of speed

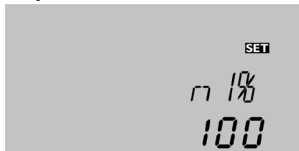

N1% , N2% , N3%

Current pump speed

Display range: 30 ... 100%

20 ... 100% if ADAP is adjusted

Indicates the current speed of the corresponding pump.

Operating hours counter

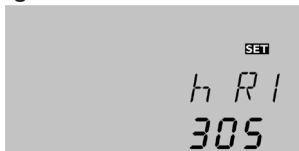

H R 0, 2, 3, 4)

Operating hours counter

The operating hours counter accumulates the solar operating hours of the relay (h R1/h R2/h R3/h R4). Full hours are displayed.

The accumulated operating hours value can be set back to 0. As soon as one operating hours channel is selected, the symbol **SET** is displayed.

→ In order to access the RESET mode of the counter, press the set button **(S)**.

The **SET** symbol flashes and the security enquiry appears.

→ Confirm the security enquiry by selecting "Yes"

→ Confirm the reset with the set button **(S)** in order to finish the reset.

In order to interrupt the RESET process, do not press any button for about 5 s. The display returns to the display mode.

Display of heat quantity

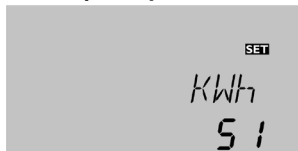

kWh/MWh:

Heat quantity in kWh/MWh

Indicates the heat quantity produced in the system. For this purpose, the heat quantity measurement option has to be activated.

The flow rate as well as the values of the reference sensors S1 (flow) and S4 (return) are used for calculating the heat quantity supplied. It is shown in kWh in the channel **kWh** and in MWh in the channel **MWh**. The overall heat quantity results from the sum of both values.

The accumulated heat quantity value can be set back to 0. As soon as one of the display channels of the heat quantity is selected, the **SET** symbol is displayed.

→ In order to access the RESET mode of the counter, press the set button **(S)**.

The **SET** symbol flashes and the security enquiry appears.

→ Confirm the security enquiry by selecting "Yes"

→ Confirm the reset with the set button in order to finish the reset.

In order to interrupt the RESET process, no button should be pressed for about 5 s. The display returns to the display mode.

Display of monitoring period



CDIS

Countdown of the monitoring period

Display range:

0 ... 30:0 ... 24 (dd:hh)

If the thermal disinfection option (**OTDIS**) is activated and the monitoring period is in progress, the remaining time of the monitoring period is displayed as **CDIS** (in hours and minutes), counting backwards.

Display of starting time

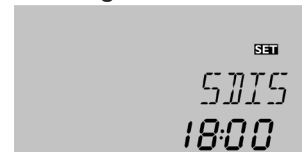

SDIS

Starting time

Display range:

0:00 ... 24:00 (o'clock)

If the thermal disinfection option (**OTDIS**) is activated and starting delay time has been adjusted, the adjusted delay time is displayed (flashing) in this channel.

Display of heating period

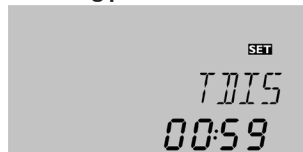

TDIS

Heating period

Display range:

0:00 ... 23:59 (hh:mm)

If the thermal disinfection option (**OTDIS**) is activated and the heating period is in progress, the remaining time of the heating period is displayed (in hours and minutes) in this channel, counting backwards.

Display of time

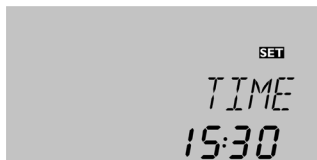

TIME

Time

Adjust the current clock time.

The following display channels are only indicated when the corresponding function is active.

Display ΔT function active

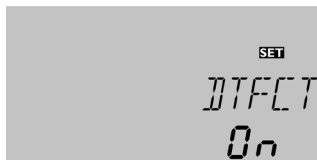

DTFCT

ΔT function active

Display thermostat function active



THERM

Thermostat function active

Display of blocking protection time

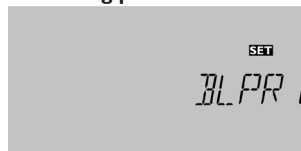

BLPR1(2, 3, 4)

Blocking protection active

In order to protect the pumps against blocking after standstill, the controller is equipped with a blocking protection function. When the blocking protection is activated, this function switches on the relays one after another every day at 12:00 a.m. for 10 s at 100%.

6.2 Adjustment channels



Note

If the controller is commissioned for the first time, the commissioning menu will start. Selecting a new system subsequently will reset all other adjustments to the factory settings.

Selecting the system



ARR

System

Adjustment range: 1 ... 9

Factory setting: 1

Selection of the appropriate system. Each system has pre-programmed options and adjustments which can be activated or changed respectively if necessary. Select the system first (see chap. 3).

ΔT control



LOAD(1, 2, 3) / DT(1, 2, 3) 0

Switch-on temperature diff.

Adjustment range: 1.0 ... 50.0K

in steps of 0.5 K

Factory setting: 6.0K

The controller works as a standard differential controller. If the switch-on difference is reached, the pump is activated. When the temperature difference reaches or falls below the adjusted switch-off temperature difference, the respective relay switches off.



LORD(1, 2, 3) / DT(2, 3) F

Switch-off temperature diff.

Adjustment range: 0.5 ... 49.5 K

in steps of 0.5 K

Factory setting: 4.0 K



Note

The switch-on temperature difference must be at least 0.5 K higher than the switch-off temperature difference. The set temperature difference must be at least 0.5 K higher than the switch-on temperature difference.

Speed control

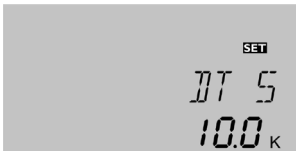

LORD(1, 2, 3) / DT(2, 3) S

Set temperature difference

Adjustment range: 1.5 ... 50.0 K

in steps of 0.5 K

Factory setting: 10.0 K



Note

To enable speed control, the corresponding relay has to be set to "Auto" (adjustment channel **MAN**) and the pump control type has to be set to Puls, or ADAP (adjustment channel **PUMP**).



LORD(1, 2, 3) / RIS(1, 2, 3)

Rise

Adjustment range: 1 ... 20 K

in steps of 1 K

Factory setting: 2 K

When the switch-on temperature difference is reached, the pump is activated at 100% speed for 10 s. Then, the speed is reduced to the minimum pump speed value.

If the temperature difference reaches the adjusted nominal value (**DT S**), the pump speed increases by one step (10 %). The response of the controller can be adapted via the parameter "Rise". If the difference increases by the adjustable rise value **RIS**, the pump speed increases by 10 % until the maximum pump speed of 100 % is reached. If, at decreasing temperatures, the temperature difference decreases by the adjustable rise value **RIS**, the pump speed decreases by 10 %.

Maximum store temperature

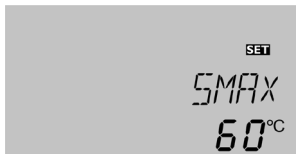

LORD(1, 2, 3) / S1(2, 3) MAX

Maximum store temperature

Adjustment range: 4 ... 95 °

in steps of 1 °C

Factory setting: 60 °C

If the store temperature reaches the adjusted maximum temperature, the store will no longer be loaded in order to avoid damage caused by overheating. The ☀ symbol is shown on the display if the store temperature exceeds the maximum value.

The corresponding reference sensor can be chosen, see "Sensor maximum store temperature".

Switch-on hysteresis -2 K

Sensor maximum store temperature



LORD(1, 2) / SMAX S1 (2)

Sensor store maximum temp.

Adjustment range:

1st store: S2, S3

2nd store: S4, S5

Store being loaded in layers: S2, S3

Factory setting:

1st store: S2

2nd store: S4

Sensor allocation for the store maximum limitation. The maximum limitation always refers to the sensor selected.

If e. g. S3 is selected, the differential control will still be carried out using S1 and S2. The temperature at S2 can exceed the adjusted limit temperature, the system will not switch off. If the value at S3 reaches the limit temperature, the system will be switched off.



Note

In 3-store systems, the reference sensor can only be selected for the numerically 1st store.

Loading store 2 and store 3

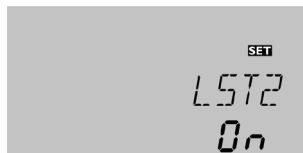

LOAD2 (3)/LST2 (3)

Loading store 2, 3
Selection: ON/OFF
Factory setting: ON

In a multi-store system, the second store or the third store can be switched off for loading by means of the parameter LST2 or LST3 respectively.

If the parameter is set to OFF, the system runs like a 2-store, or a 1-store system respectively. The representation in the display remains the same.

Pump control



PUMP/PUMP1 (2, 3)

Pump control
Selection: OnOF, Puls, ADAP
Factory setting: OnOF

With this parameter, the pump control type can be adjusted. The following types can be selected:

Adjustment for standard pump without speed control:

- OnOF : Pump on/pump off

Adjustment for a standard pump with speed control:

- PULS : Burst control via semiconductor relay

Adjustment for a high-efficiency pump (HE pump) with speed control via adapter:

- ADAP : Pump on/pump off; the corresponding relay (R1 ... 3) remains switched on for one hour after the switch-off condition has been fulfilled.

Speed control can be carried out via an adapter, e. g. the VBus®/PWM interface adapter.



Note

With the factory setting, speed control is not possible.



Note

For more information about connecting HE pumps, see page 34.

Minimum speed

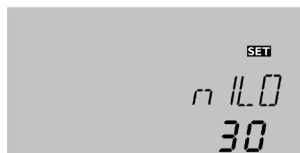

PUMP1 (2, 3)/n1 (2, 3) LO

Speed control
Adjustment range: 30 ... 100 %;
20 ... 100% if ADAP is adjusted
in steps of 5%
Factory setting: 30 %

In the adjustment channel **n1(2, 3)LO**, a relative minimum speed for connected pumps can be allocated to the outputs R1, R2 and R3.



Note

When loads which are not speed-controlled (e. g. valves) are used, the value of the corresponding relay (n1, n2, n3) must be set to 100% or the pump control type must be set to OnOF in order to deactivate pump speed control.

Maximum speed

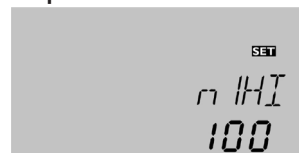

PUMP1 (2, 3)/n1 (2, 3) HI

Speed control
Adjustment range: 30 ... 100 %;
20 ... 100% if ADAP is adjusted
in steps of 5%

Factory setting: 100 %

In the adjustment channel **n1(2, 3)HI**, a relative maximum speed for connected pumps can be allocated to the outputs R1, R2 and R3.



Note

When loads which are not speed-controlled (e. g. valves) are used, the value of the corresponding relay (n1, n2, n3) must be set to 100% or the pump control type must be set to OnOF in order to deactivate pump speed control.

Collector emergency shutdown

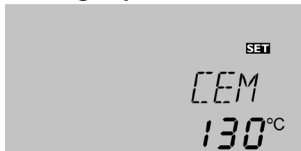

COL(1,2) / CEM(1,2)

Collector temperature limitation

Adjustment range: 80... 200 °C

in steps of 1 °C

Factory setting: 130 °C

Switch-on hysteresis: -10 K

When the collector temperature exceeds the adjusted collector emergency temperature (**CEM** / **CEM1** / **CEM2**), the solar pump (R1/R2) is switched off in order to protect the system components against overheating (collector emergency shutdown). If the maximum collector temperature is exceeded, Δ is displayed (flashing).

Collector cooling



COL(1,2) / OCCO(1,2)

Selection: OFF/ON

Factory setting: OFF

This function is used for keeping the system temperatures and consequently the thermal load as low as possible.

When the store temperature exceeds the adjusted maximum store temperature, the solar system is switched off. If the collector temperature increases to the adjusted maximum collector temperature, the so-

lar pump is activated until the collector temperature falls below the maximum collector temperature. The store temperature may then exceed the maximum temperature, but only up to 95°C (emergency shutdown of the store).

If the collector cooling is active, ☀ is displayed (flashing).

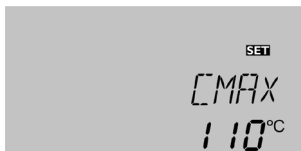

COL(1,2) / OCCO(1,2) / CMAX(1,2)

Collector maximum temp.

Adjustment range: 70... 160 °C

in steps of 1 °C

Factory setting: 110 °C

Switch-on hysteresis: -5K



Note

This function is only available, if the system cooling function and the heat dump function are deactivated.

Minimum collector limitation



COL(1,2) / CMI(1,2)

Collector minimum temp.

Selection: ON/OFF

Factory setting: OFF



COL(1,2) / CMI(1,2) / CMIN(1,2)

Collector minimum temp.

Adjustment range: 10... 90 °C

in steps of 0.5 °C

Factory setting: 10 °C

The minimum collector temperature is the minimum switch-on temperature which must be exceeded for the solar pump (R1/R2/R3) to switch on. The minimum temperature prevents the pump from being switched on too often at low collector temperatures. If the collector temperature falls below the adjusted minimum temperature, ☀ is displayed (flashing).

Tube collector function



COL / OTCO(1,2)

Tube collector function

Selection: ON/OFF

Factory setting: OFF

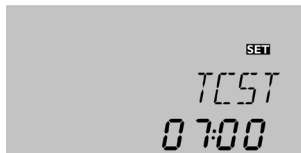

COL / OTCO (1, 2) / TCST (1, 2)

Starting time

Adjustment range: 00:00 ... 23:00

in steps of 01:00

Factory setting: 07:00

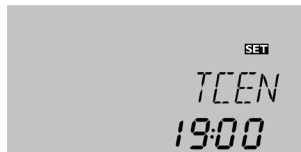

COL / OTCO (1, 2) / TCEN (1, 2)

Ending time

Adjustment range: 00:30 ... 23:30

in steps of 00:30

Factory setting: 19:00



COL / OTCO (1, 2) / TCRU (1, 2)

Runtime

Adjustment range: 30 ... 500 s

in steps of 5 s

Factory setting: 30 s

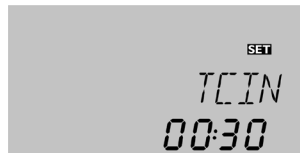

COL / OTCO (1, 2) / TCIN (1, 2)

Standstill interval

Adjustment range: 5 ... 60 min

in steps of 00:01

Factory setting: 30 min

This function helps overcome the non-ideal sensor position with some tube collectors.

This function operates within an adjusted time frame, beginning at **TCST** and ending at **TCEN**. It activates the collector circuit pump for an adjustable runtime (**TCRU**) between adjustable standstill intervals (**TCIN**) in order to compensate for the delayed temperature measurement.

If the runtime **TCRU** is set to more than 10 s, the pump will be run at 100 % for the first 10 s of the runtime. For the remaining runtime, the pump will be run at the adjusted minimum speed **nLO**.

If the collector sensor is defective or the collector is blocked, this function is suppressed or switched off.

2-collector systems

In 2-collector systems, the tube collector function is available for each collector field (**OTCO2**).

If one of the collector fields is being loaded, the heat transfer fluid flows through the inactive field and only the corresponding relay is energised.

Multi-store systems

If the tube collector function is activated, the speed of the solar pump will decrease to the minimum speed **nLO** during the loading break time. The solar loading of the subordinate store will continue.

In 2-collector systems, the collector field which has

been active before the loading break time remains active during the loading break time, unless the tube collector function of the inactive field becomes active.

Antifreeze function



COL (1) / OCFR

Antifreeze function

Selection: ON / OFF

Factory setting: OFF



COL (1) / OCFR / CFR 0

Antifreeze temperature on

Adjustment range: -40.0 ... +9.0 °C

in steps of 0.5 °C

Factory setting: 4.0 °C



COL (1) / OCFR / CFR F

Antifreeze temperature off

Adjustment range: -39.0 ... +8.0 °C

in steps of 0.5 °C

Factory setting: 5.0 °C



COL (1) / OCFR / FRPST

Store sensor selection

(in 2- and 3-store systems only)

Selection: 1, 2, 3

Factory setting: 1

The antifreeze function activates the loading circuit between the collector and the store when the collector temperature falls below the adjusted temperature **CFR O**. This will protect the fluid against freezing or coagulating. If **CFR F** is exceeded, the solar pump will be switched off again. The antifreeze function will be suppressed if the store temperature of the selected store falls below 5 °C. In 2-store systems, the function will in this case be switched to the 2nd store. In a system with store loading in layers it will be switched to the upper store zone. If the temperature of the 2nd or 3rd store (or of the upper store zone respectively) also falls below 5 °C, the system will be switched off.



Note

This function can only become active if the store temperature is higher than the collector temperature.



Note

Since this function uses the limited heat quantity of the store, the antifreeze function should be used in regions with few days of temperatures around the freezing point.

Priority logic



LLOGI / LOGIC

Priority logic

Selection:

Prio, SuLA, StUF, PAR, bLO

Factory setting: PRIO



LLOGI / PRIO1 (2, 3)

Priority

Adjustment range: 1, 2, 3

Factory setting: 1



LLOGI / TLB

Loading break time

Adjustment range: 1 ... 30 min

in steps of 1 min

Factory setting: 2 min



LLOGI / TRUN

Oscillating loading runtime

Adjustment range: 1 ... 30 min

in steps of 1 min

Factory setting: 15 min

Priority logic can be used in 2-store systems, 3-store systems or systems with store loading in layers and determines how the heat is divided between the stores. Different types of priority logic are adjustable:

1. Store sequence control (PRIO)
2. Successive loading (SuLA)
3. Progressive loading (StUF)
4. Parallel loading (PAR)
5. Loading in blocks (bLO)

1. In store sequence control (PRIO), a priority (1 = highest priority) is assigned to the store (PRIO1 = store 1, PRIO2 = store 2; the priority of the 3rd store is determined by the priority of the first 2 stores).

The priority store will be loaded if its switch-on conditions are fulfilled and if it is not blocked. If the priority store is not blocked but its switch-on conditions are not fulfilled, the store sequence control starts provided that the switch-on conditions of the subordinate store are fulfilled. If a subordinate store can be loaded, it will be loaded for the oscillating loading time tRUN. After the loading time has ended, the pump is switched off for the adjustable loading break tLB. If during this time the priority store can be loaded, it will be loaded. If the priority store has reached its maximum temperature, the subordinate store next in priority will be loaded. If the switch-on conditions for the first subordinate store are not fulfilled, but the switch-on conditions for the last subordinate store are fulfilled, the store sequence control will start working on both subordinate stores. If the first subordinate store has also reached its maximum temperature, the last subordinate store will be loaded up to its maximum temperature, if possible, without store sequence control.

2. In successive loading (SuLA), the priority store will be loaded up to its maximum temperature first. Only when the priority store is fully loaded, will the subordinate store(s) next in priority be loaded.

3. In progressive loading (StUF), the store with the lowest temperature is loaded first. As soon as the temperature of the store being loaded exceeds the temperature of the next store by 5 K, loading switches to the cooler store. If the temperature of that store is by 5 K higher than the temperature of the third store, loading switches to the third store. From then on, progressive loading will continue in a loop, as long as there is a sufficient temperature difference between the store being loaded and the collector.

4. In parallel loading (PAR), all stores with a sufficient temperature difference to the collector are loaded in parallel up to their maximum temperatures.

This option is only available if each store has its own pump (ARR = 3, 4, 6).



LL06/LOGIC/BL01 (2)

Loading in blocks

Selection:

PRIO, SuLA, StUF

Factory setting: PRIO

5. In systems with 3 stores or 2 stores and store loading in layers, **bLO** loading is possible. This means that 2 stores are combined to one. The **PRIO1...3** adjustment determines the loading priority and which stores are being combined. Stores with the same PRIO adjustment are combined. This common value is used as the loading priority of the combined store. In the channel **BL01**, the loading type of the combined store, in relation to the single remaining store, can be adjusted.

In the channel **BL02**, the loading type of the two individual stores of the combined store can be adjusted.

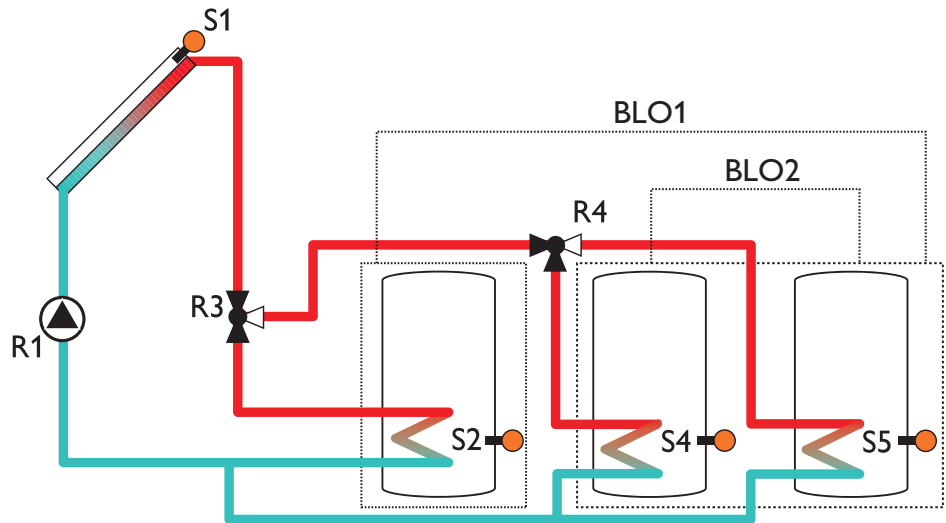

Store set option



LLOGI/OSTS

Store set option

Selection: ON/OFF

Factory setting: OFF

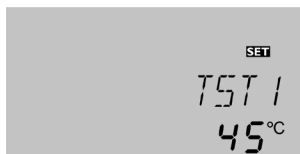

LLOGI/TST1

Set temperature store 1

Adjustment range: 4 ... 85 °C

in steps of 1 °C

Factory setting: 45 °C

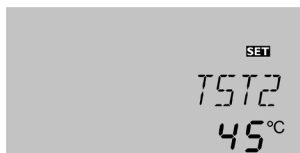

LLOGI/TST2

Set temperature store 2

Adjustment range: 4 ... 85 °C

in steps of 1 °C

Factory setting: 45 °C

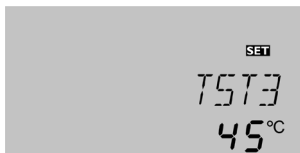

LLOGI/TST3

Set temperature store 3

Adjustment range: 4 ... 85 °C

in steps of 1 °C

Factory setting: 45 °C

Additionally, the following options can be activated:

Store set option OSTS: With this function, a set temperature can be adjusted for each store.

If the selected priority store reaches its set temperature, the subordinate stores will be loaded successively up to their set temperatures. After that, the priority store is loaded up to its maximum temperature, then store 2 and then store 3.

Spreaded loading option

(only in ARR 3, 4, 6 with differing priority)



LLOGI/PRIO/OSE

Spreaded loading option

Selection: ON/OFF

Factory setting: OFF

Spreaded loading option OSE: In 2- and 3-store systems with 2 or 3 pumps, a spreaded loading option can be activated:

As soon as the adjustable spread difference **DTSE** between the collector and the reference store is reached, the absorption store will be loaded in paral-

lel unless it is blocked. If the temperature difference falls by 2 K below **DTSE**, the absorption store will no longer be loaded.



LLOGI/PRIO/DTSE

Temperature diff. spreaded loading

Adjustment range: 20 ... 90 K

in steps of 1 K

Factory setting: 40 K

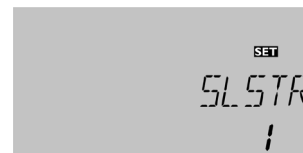

LLOGI/PRIO/SLSTR

Reference store

Adjustment range: 1, 2, 3

Factory setting: 1

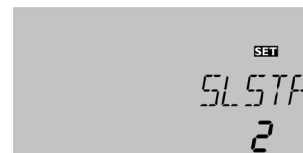

LLOGI/PRIO/SLSTR

Absorption store

Adjustment range: 1, 2, 3

Factory setting: 2



Note

If the store set option is activated along with the spreaded loading function, the spreaded loading function will only be active until the set temperature of the selected store is reached.



Note

The absorption store can only be selected in 3-store systems with 3 pumps.

Pause control



LLOGI/PSPEE

Pause speed

Selection: ON/OFF

Factory setting: OFF

If the pause speed is activated, the relay of the store which has been loaded last remains switched on during the loading break time. Speed is determined by the value adjusted in **nLO**.



LLOGI/PDELA

Pump delay

Selection: ON/OFF

Factory setting: OFF

This function takes into account the actuation times of valves and switches on the pump with a delay.

If the pump delay is activated, the corresponding relay for the valve will be energised first. The pump(s) will be activated with the delay time (200s).



Note

In systems with pump logic, the parameter **PDELA** is not available.

Cooling functions

Different cooling functions can be activated: system cooling, store cooling and heat dump.



Note

If the temperature at the store sensor reaches 95°C, all cooling functions will be blocked. The switch-on hysteresis is -2 K.

System cooling



COOL/DSYC

System cooling option

Adjustment range: OFF/ON

Factory setting: OFF



Note

This function will only be available if the collector cooling function and the heat dump function are deactivated.

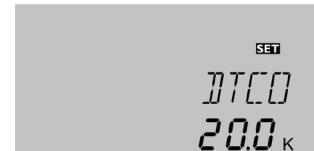

COOL/DTCO

Switch-on temperature diff.

Adjustment range: 1.0 ... 30.0 K

in steps of 0.5 K

Factory setting: 20,0 K

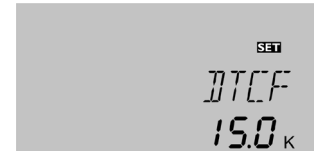

COOL/DTCF

Switch-off temperature diff.

Adjustment range: 0.5 ... 29.5 K

in steps of 0.5 K

Factory setting: 15.0 K

The system cooling function aims to keep the solar system operational for a longer time. The function overrides the maximum store temperature to provide thermal relief of the collector field and the heat transfer fluid on hot days.

If the store temperature is higher than the adjusted maximum store temperature and the switch-on temperature difference **DTCO** is reached, the solar system remains activated or is switched on. Solar loading is continued until either the temperature difference falls below the adjusted value **DTCF** or the collector emergency shutdown temperature **CEM** is reached.

If the system cooling function is active, ☀ is shown on the display (flashing).

Store cooling



COOL/OSTC

Store cooling option

Selection: OFF/ON

Factory setting: OFF

When the store cooling function is activated, the controller aims to cool down the store during the night in order to prepare it for solar loading on the following day.

If the adjusted maximum store temperature (**S1MAX / S2MAX / S3MAX**) is exceeded and the collector temperature falls below the store temperature, the system will be reactivated in order to cool down the store.

Reference temperature differences are **DT1 (2, 3) O** and **DT1 (2, 3) F**.

Heat dump



COOL/OHDP

Heat dump

Selection: ON/OFF

Factory setting: OFF



COOL/OTCL

Overtemperature collector

Adjustment range: 70 ... 160 °C
in steps of 1 °C

Factory setting: 110 °C



COOL/OTPUM

Pump or valve logic

Selection: ON/OFF

Factory setting: OFF



COOL/HDREL

Heat dump relay

Selection: system dependent

Factory setting: 3/4

If the heat dump function **OHDP** is activated, the selected relay is energised with 100%, if the collector temperature reaches the adjusted collector overtemperature **OTCL**. If the collector temperature falls by 5 K below the adjusted collector overtemperature **OTCL**, the relay will be switched off.

A selection can be made between pump logic and valve logic (**OTPUM ON** = pump logic, **OTPUM OFF** = valve logic). If pump logic is selected, the relay for solar loading switches off and the relay for heat dump remains switched on.

The relay for the heat dump function can be selected in the **HDREL** channel.



Note

The adjustable value **OTCL** is locked against the collector emergency temperature **CEM** by 10 K. The heat dump function will only be available if the collector cooling function and the system cooling function are deactivated.

Heat exchange function



DT4/DT4O

Switch-on temperature diff.

Adjustment range: 1.0 ... 30.0 K
in steps of 0.5 K

Factory setting: 6.0 K

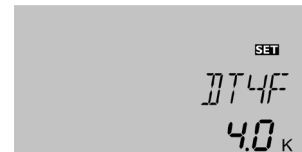

DT4/DT4F

Switch-off temperature diff.

Adjustment range: 0.5 ... 29.5 K
in steps of 0.5 K

Factory setting: 4.0 K

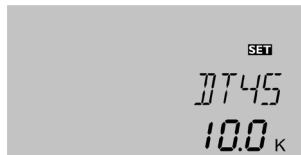

DT4/DT4S

Set temperature difference

Adjustment range: 1.5 ... 50.0 K

in steps of 0.5 K

Factory setting: 10.0 K



DT4/RIS4

Rise

Adjustment range: 1 ... 20 K

in steps of 1 K

Factory setting: 2 K

The heat exchange function is used for transporting heat from store 2 to store 1.

The reference sensor (heat source) for the heat exchange function for store 2 is sensor S5 (TST2T). The reference sensor (heat sink) for store 1 (TST1T) is S3. It is used as a reference sensor for the differential function and for the maximum limitation.

Additionally, minimum and maximum temperature limitations and the corresponding switch-on and switch-off differences can be set for the independent temperature differential control. Both switch-on and switch-off temperature differences **DT4O** and **DT4F** as well as the set temperature difference **DT4S** and rise **RIS4** are valid.



Note

The heat exchange function is only available in arrangement 2 and 4.

Maximum temperature limitation for the heat exchange



DT4/MAX4O

Switch-on temperature

Adjustment range: 0.5 ... 95.0 °C

in steps of 0.5 °C

Factory setting: 60.0 °C



DT4/MAX4F

Switch-off temperature

Adjustment range: 0.0 ... 94.5 °C

in steps of 0.5 °C

Factory setting: 58.0 °C

If the adjusted value **MAX4O** is exceeded, the relay will be switched off. If the temperature falls below the adjusted value **MAX4F**, the relay will be energised.

Minimum temperature limitation for the heat exchange

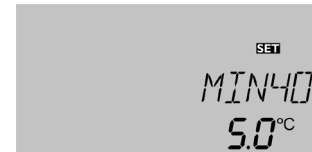

DT4/MIN4O

Switch-on temperature

Adjustment range: 0.0 ... 94.5 °C

in steps of 0.5 °C

Factory setting: 5.0 °C

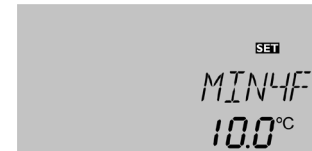

DT4/MIN4F

Switch-off temperature

Adjustment range: 0.5 ... 95.0 °C

in steps of 0.5 °C

Factory setting: 10.0 °C

If the temperature falls below the adjusted value **MIN4O**, the relay will be switched off. If the adjusted value **MIN4F** is exceeded, the relay will be energised.

ΔT function



ODTFT

ΔT function

Selection: ON/OFF

Factory setting: OFF

The optional ΔT function uses the sensors S3 (heat source) and S5 (heat sink) to switch the adjustable relay.



Note

The optional ΔT function is available in arrangement 1 and 3 only.



ODTFT/DT40

Switch-on difference

Adjustment range: 1.0 ... 50.0 K

in steps of 0.5 K

Factory setting: 6.0 K



ODTFT/DT4F

Switch-off difference

Adjustment range: 0.5 ... 49.5 K

in steps of 0.5 K

Factory setting: 4.0 K

The switch-on and switch-off differences **DT40** and **DT4F** are valid for this function.

Minimum limitation for the ΔT function

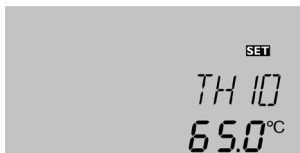

DT4/TH10

Switch-on temperature

Adjustment range: 0.0 ... 95.0 °C

in steps of 0.5 °C

Factory setting: 65.0 °C

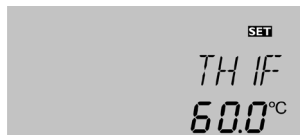

DT4/TH1F

Switch-off temperature

Adjustment range: 0.0 ... 95.0 °C

in steps of 0.5 °C

Factory setting: 60.0 °C

If the adjusted value **TH10** is exceeded, the relay will be switched on. If the temperature falls below the adjusted value **TH1F**, the relay will be switched off.

Maximum limitation for the ΔT function

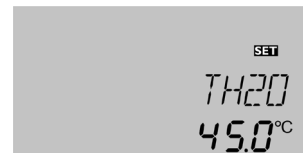

DT4/TH20

Switch-on temperature

Adjustment range: 0.0 ... 95.0 °C

in steps of 0.5 °C

Factory setting: 45.0 °C

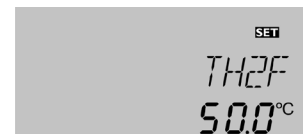

DT4/TH2F

Switch-off temperature

Adjustment range: 0.0 ... 95.0 °C

in steps of 0.5 °C

Factory setting: 50.0 °C

If the temperature falls below the adjusted value **TH20**, the relay will be switched on. If the temperature exceeds the adjusted value **TH2F**, the relay will be switched off.

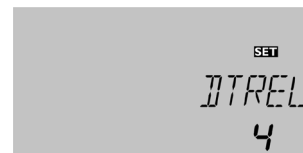

ODTFT/DTREL

Relay

Selection: System 1: R2, R4

System 3: R3, R4

Factory setting: 4

The relay for the ΔT function can be selected.

Freely adjustable thermostat function

Afterheating

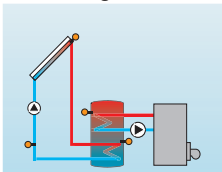

Use of surplus energy

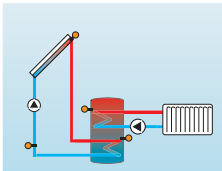

The thermostat function works independently from the solar operation and can be used for using surplus energy or for afterheating.

- **AH O < AH F**

thermostat function for afterheating

- **AH O > AH F**

thermostat function for using surplus energy



OTH

Thermostat function

Adjustment range: ON/OFF

Factory setting: OFF

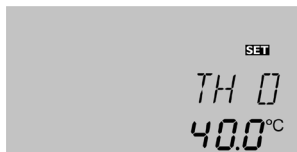

OTH/TH 0

Thermostat switch-on temp.

Adjustment range: 0.0 ... 250.0 °C

in steps of 0.5 °C

Factory setting: 40.0 °C

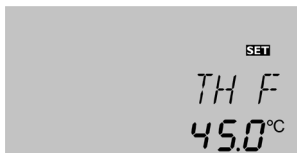

OTH/TH F

Thermostat switch-off temp.

Adjustment range: 0.0 ... 250.0 °C

in steps of 0.5 °C

Factory setting: 45.0 °C

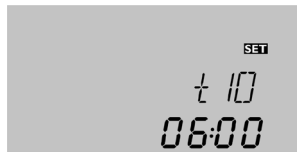

OTH/t10

Switch-on time 1

Adjustment range: 00:00 ... 23:45

Factory setting: 06:00

in steps of 15 min

In order to block the thermostat function for a certain period, there are three time frames $t_1 \dots t_3$. The switch-on and switch-off times can be adjusted in steps of 15 minutes. If the switch-on and the switch-off times are identical, the time frame is inactive.

If the thermostat function should run from 06:00 a.m. and 09:00 a.m. only, adjust t_{1O} to 06:00 a.m. and t_{1F} to 09:00 a.m.

The first time frame is factory set from 06:00 to 22:00.

If the switch-on and switch of times of a frame are set to an identical value, the time frame is inactive. If all time frames are set to 00:00, the thermostat function is solely temperature dependent.

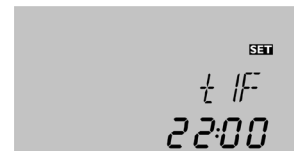

OTH/t1F

Switch-off time 1

Adjustment range: 00:00 ... 23:45

Factory setting: 22:00



OTH/T2 (3) 0

Switch-on time 2 (3)

Adjustment range: 00:00 ... 23:45

Factory setting: 00:00



OTH/T2 (3) F

Switch-off time 2 (3)

Adjustment range: 00:00 ... 23:45

Factory setting: 00:00



OTH/STH

Thermostatic afterheating sensor

Selection: S3, S5

Factory setting: S3/S5

Depending on the system selected, the sensor for the thermostatic afterheating can either be selected or is pre-set.



OTH/RTH

Thermostatic afterheating relay

Selection:

Factory setting: R3

Depending on the system selected, the relay for the thermostatic afterheating can either be selected or is pre-set.

Manual mode



MAN/MAN1 (2, 3):

Adjustment range: Auto, ON, OFF, nLO, nHI

Factory setting: Auto



MAN/MAN4

Adjustment range: Auto, ON, OFF

Factory setting: Auto

For control and service work, the operating mode of the controller can be manually adjusted. For this purpose, select the adjustment value **MAN**. The following adjustments can be carried out:

Auto : relay in automatic mode

ON : relay is switched on

OFF : relay is switched off

nLO : relay is switched with adjusted minimum speed

nHI : relay is switched with adjusted maximum speed

The controller is equipped with a shortcut that enables a quick access to the MAN menu (manual mode).

➔ In order to access the MAN menu, press buttons **6** and **7** at the same time, then press button **2**.



Note

Always adjust the operating mode back to "Auto" when the control and service work is completed. Otherwise normal operation will not be possible.

Blocking protection

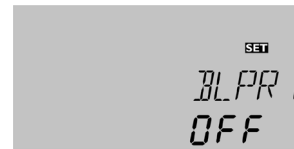

BLPR (2, 3)

Adjustment range: ON / OFF

Factory setting: ON

In order to protect the pumps against blocking after standstill, the controller is equipped with a blocking protection function. This function switches on the relays one after another every day at 12:00 a.m. for 10 s at 100%.

Option: Thermal disinfection (OTDIS)



OTDIS

Thermal disinfection function

Adjustment range: ON/OFF

Factory setting: OFF

This function helps to contain the spread of Legionella in the upper DHW store zone by systematically activating the afterheating.

Reference sensor for the thermal disinfection is the numerically first free sensor! Reference relay is the numerically first free relay!

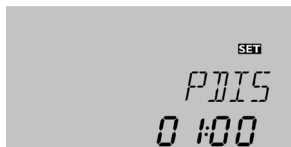

OTDES / PDIS

Monitoring period

Adjustment range: 0 ... 30:0 ... 24 (dd:hh)

Factory setting: 01:00

For thermal disinfection, the temperature in the upper DHW store zone has to be monitored. This protection is ensured when, during the monitoring period, the disinfection temperature is continuously exceeded for the entire disinfection period.

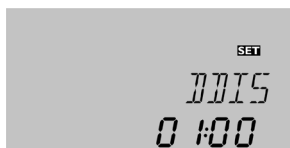

OTDIS / DDIS

Disinfection period

Adjustment range: 00:00 ... 23:59

Factory setting: 01:00

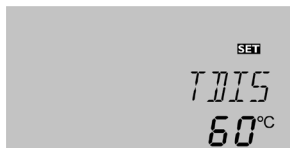

OTDIS / TDIS

Disinfection temperature

Adjustment range: 0 ... 95 °C

in steps of 1 °C

Factory setting: 60 °C

If the thermal disinfection function is activated, the monitoring period starts as soon as the temperature at the reference sensor falls below the disinfection temperature.

When the monitoring period ends, the reference relay activates the afterheating. The disinfection period starts to count as soon as the temperature at the allocated sensor exceeds the disinfection temperature.

If the temperature at the reference sensor exceeds the disinfection temperature by more than 5K, the reference relay switches off until the temperature has fallen below a value of 2K above the disinfection temperature.

Thermal disinfection can only be completed when the disinfection temperature is exceeded for the duration of the disinfection period without interruption.

If the disinfection conditions have been fulfilled by solar loading before the monitoring period ends, thermal disinfection is considered complete and a new monitoring period begins.



Note

If the thermal disinfection option OTDIS is activated, the display channels TDIS and CDIS will be displayed. TDIS will be displayed regardless of the temperature measured at the reference sensor.

Due to the flexible control logic, the exact time of thermal disinfection is not predictable. In order to set a fixed time for the disinfection, the starting delay can be used.

Thermal disinfection with starting delay

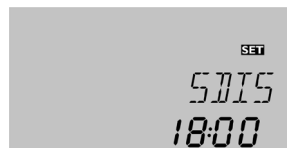

OTDIS / SDIS

Starting time

Adjustment range: 0:00 ... 24:00

Factory setting: 00:00

full hours only

When a starting time for thermal disinfection with starting delay is adjusted, afterheating activation will be delayed until that time, even after the monitoring period has ended.

If the monitoring period ends, for example, at 12:00 o'clock, and the starting time has been set to 18:00, the reference relay will be energised with a delay of 6 hours at 18:00 instead of 12:00 o'clock.

If, before the delay time has elapsed, the disinfection conditions are fulfilled by solar loading, thermal disinfection is considered complete and a new monitoring period begins.

If the starting time is adjusted to 00:00 (factory setting), the delay function is inactive.

When thermal disinfection is activated, different display channels appear depending on the current status of the function (see also p. 42):

CDIS - countdown of the monitoring period

DDIS - countdown of the disinfection period

TDIS - substitutes TSTT during the disinfection period

SDIS - displays the adjusted starting time (flashing) during the delay time after the monitoring period has ended

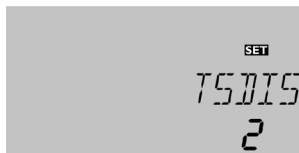

OTDIS / TSDIS

Sensor thermal disinfection

Adjustment range: 2,3,4,5

Factory setting: system dependent

For this function, free sensors at an appropriate position can be selected.



OTDIS / RDIS

Relay thermal disinfection

Adjustment range: 2, 3, 4

Factory setting: system dependent

The relay for the thermal disinfection function can be selected.

Parallel relay



OPARR / PARRE

Parallel relay

Adjustment range 2, 3, 4

Factory setting: 2



With this function, e. g. a valve can be controlled in parallel to the pump via a separate relay **PARRE**.

If solar loading takes place (R1 and/or R2) or if a solar function is active, the relay selected will be energised. The parallel relay can also be energised inversely (**INVER**).



Note

If R1 and/or R2 are in the manual mode, the selected parallel relay will not be energised.

Heat quantity measurement

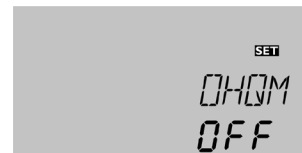

OHQM

Heat quantity measurement

Adjustment range: OFF/ON

Factory setting: OFF

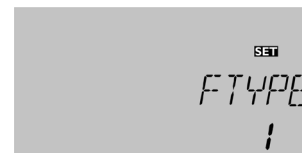

OHQM / FTYPE

Flow rate detection type

Selection: 1,2

Factory setting: 1

The heat quantity measurement can be carried out in 2 different ways (see below): without flowmeter (using a fixed flow rate value) or with a V40 flowmeter.

- ➔ Enable the heat quantity measurement option in the channel OHQM
- ➔ Select the type of flow rate detection in the channel FTYPE

Flow rate detection type:

- 1 : fixed flow rate value
- 2 : V40

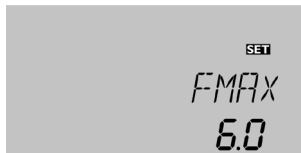

OHQM/FMAX

Flow rate in l/min

Adjustment range: 0.5 ... 100.0

in steps of 0.1

Factory setting: 6.0

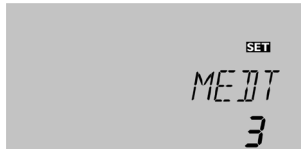

OHQM/MEDT

Heat transfer fluid

Adjustment range: 0 ... 3

Factory setting: 3

Heat quantity measurement with fixed flow rate value

The heat quantity measurement calculation (estimation) uses the difference between the flow and return temperatures and the entered flow rate (at 100 % pump speed).

- ➔ Adjust 1 in the channel FTYPE
- ➔ Read the flow rate (l/min) and adjust it in the channel FMAX.
- ➔ Adjust the antifreeze type and concentration of the heat transfer fluid in the channels MEDT and MED%.



Note

FMAX cannot be selected in systems with 2 solar pumps (ARR 3, 4, 6, 8, 9).



Note

The heat quantity measurement calculation (estimation) uses the difference between the flow and return temperatures and a flow rate value calculated from the entered flow rate (at 100 % pump speed) and the current pump speed.



OHQM/MED%

Antifreeze concentration in vol. %

(MED% is "hidden" when MEDT 0 or 3 is used)

Adjustment range: 20 ... 70%

in steps of 1 %

Factory setting: 45%

Antifreeze type:

- 0 : water
- 1 : propylene glycol
- 2 : ethylene glycol
- 3 : Tyfocor® LS/G-LS

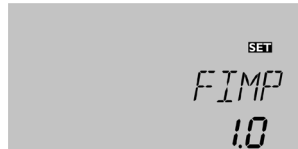

OHQM/FIMP

Pulse rate

Adjustment range: 0.5 ... 99.0

in steps of 0.1

Factory setting: 1.0

Heat quantity measurement with V40 flowmeter

The heat quantity measurement calculation uses the difference between the flow and return temperatures and the volume flow transmitted by the flowmeter.

- ➔ Adjust 2 in the channel FTYPE
- ➔ In the channel FIMP, adjust the impulse rate corresponding to the V40 flowmeter used.
- ➔ Adjust the antifreeze type and concentration of the heat transfer fluid in the channels MEDT and MED%.

HQM sensors

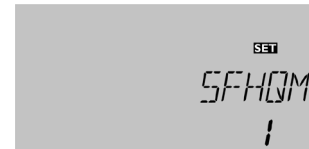

OHQM/SFHQM

Flow sensor

Adjustment range: 1, 3, 5

Factory setting: 1

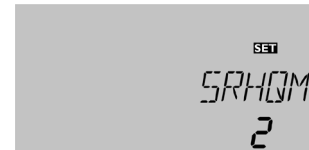

OHQM/SRHQM

Return sensor

Adjustment range: 2, 3, 5

Factory setting: 2

For this function, free sensors at an appropriate position can be selected as flow and return sensors.

- ➔ In the channel SFHQM, select the flow sensor.
- ➔ In the channel SRHQM, select the return sensor.

Time and date

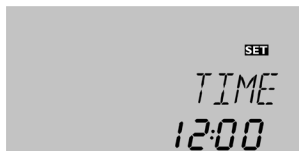

DATE/TIME

Time

Adjustment range: 00:00 ... 23:59

Factory setting: 12:00



DATE/YYYY

Year

Adjustment range: 2010 ... 2099

Factory setting: 2010



DATE/MM

Month

Adjustment range: 01 ... 12

Factory setting: 03

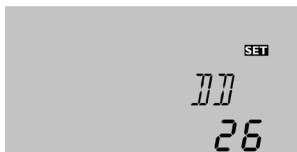

DATE/DD

Day

Adjustment range: 01 ... 31

Factory setting: 15

The date and time can be entered. Both are required for the thermostat function.

ROSA



ROSA

ROSA numbers

Adjustment range: 0000 ... 9999

In the ROSA channel, the 4-digit number given by the RESOL Online Service Assistant can be entered.

The following table shows the numbers available for the BX L with the corresponding system layouts.

System	ROSA number
ARR1	5
ARR2	16
ARR3	6
ARR4	17
ARR5	225
ARR6	226
ARR7	227
ARR8	29
ARR9	228

Valve logic

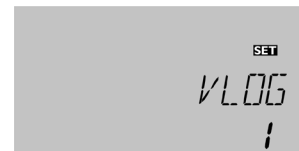

VLOG

Valve logic

Adjustment range: 1, 2, 3, 4

Factory setting: 1

In this adjustment channel the valve logic can be adjusted.

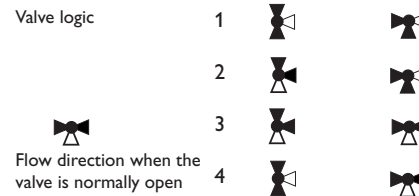

Temperature unit



UNIT

Temperature unit

Adjustment range: °C, °F

Factory setting: °C

In this adjustment channel the temperature unit can be chosen.

The unit can be switched between °C and °F during operation.

Language



LANG

Language

Adjustment range: dE, En, ES, Fr

Factory setting: En

In this adjustment channel, the menu language can be chosen.

- dE : German
- En : English
- ES : Spanish
- Fr: French

SD card

If an SD card is used, **COM** is shown on the display. If the SD card is full, **COM** is flashing.



OSDC

SD card

Selection: ON/OFF

Factory setting: OFF

Starting the logging

➔ Insert the SD card into the slot

Logging will start immediately.

➔ Adjust the desired logging interval LOGI

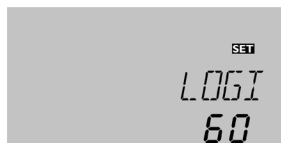

OSDC/LOGI

Logging interval

Adjustment range: 1 ... 1200 s

Factory setting: 60 s



OSDC/LLOG

Linear logging

Selection: ON/OFF

Factory setting: OFF

When **LLOG** is activated, data logging will stop if the capacity limit is reached. The message **CFULL** will be displayed.

When **LLOG** (linear logging) is deactivated, the oldest data logged onto the SD card will be overwritten as soon as the capacity limit is reached.



OSDC/REMC

Safely remove card

Adjustment range: ON/OFF

Factory setting: OFF

Completing the logging process

➔ Select the menu item **REMC**

➔ After **-REM** is displayed remove the card from the slot



OSDC/FORM

Format card

Formatting the SD card

➔ Select the menu item **FORM**

➔ During the formatting process, **--FORM** will be displayed.

The content of the card will be deleted and the card will be formatted with the FAT 16 file system.

Messages possible	Description
FSYS	File system error
CTYP	Card type is not supported
WRIT	Error during writing
NOCRD	No card in slot
LOGG	Logging is possible
WRITP	Card is write-protected
CFULL	Card full
RTIME	Remaining logging time in days
REMC	Safely remove card command
-REM	Card is being removed
FORM	Formatting SD card command
-FORM	Formatting in progress
LOGI	Logging interval in seconds
LLOG	Linear logging



Note

Because of the increasing size of the data packets, the remaining logging time does not decrease linearly. The data packet size can increase, e. g. with the increasing operating hours value.

6.3 Overview of options and their parameters

In the following, the additional options and parameters are listed.

The options and parameters displayed depend on the system as well as on the options and functions which

have been selected. Some of the options and parameters will only be displayed, if they are available with the individual adjustments.

Channels	Sub channel 1	Sub channel 2	Factory setting	Change to	Description	Page
Channel						
COOL >					Cooling functions	
	OSYC*		OFF		System cooling	51
	DTCO		20 K		Switch-on difference system cooling	51
	DTCF		15 K		Switch-off difference system cooling	51
	OSTC		OFF		Store cooling	52
	OHDP*		OFF		Heat dump	52
	OTCL		110 °C		Overtemperature collector	52
	OTPUM		OFF		Pump or valve logic	52
ODTFT >					ΔT function option	54
	DT4O		6 K		ΔT function switch-on difference	54
	DT4F		4 K		ΔT function switch-off difference	54
	RIS4		2 K		ΔT function rise	54
	TH1O		65.0 °C		Thermostat function 1 switch-on temperature	54
	TH1F		60.0 °C		Thermostat function 1 switch-off temperature	54
	TH2O		45.0 °C		Thermostat function 2 switch-on temperature	54
	TH2F		50.0 °C		Thermostat function 2 switch-off temperature	54
	DTREL		4		ΔT function relay	54
OTH >					Thermostat function option	
	THNHE		40 °C		Thermostatic afterheating switch-on temperature	55
	THNHA		45 °C		Thermostatic afterheating switch-off temperature	55
	STH		3/5		Thermostatic afterheating sensor	56
	RTH				Thermostatic afterheating relay	
	t1O		06:00		Thermostatic afterheating switch-on time 1	55
	t1F		22:00		Thermostatic afterheating switch-off time 1	55
	t2O		00:00		Thermostatic afterheating switch-on time 2	56
	t2F		00:00		Thermostatic afterheating switch-off time 2	56
	t3O		00:00		Thermostatic afterheating switch-on time 3	56
	t3F		00:00		Thermostatic afterheating switch-off time 3	56
PUMP >					Speed	
	PUMP1		OnOF		Speed variant pump 1	45

Channels						
Channel	Sub channel 1	Sub channel 2	Factory setting	Change to	Description	Page
	n1LO		30 %		Minimum speed	45
	n1HI		100 %		Maximum speed	45
	PUMP2		OnOF		Speed variant pump 2	45
	n2LO		30 %		Minimum speed	45
	n2HI		100 %		Maximum speed	45
	PUMP3		OnOF		Speed variant pump 3	45
	n3LO		30 %		Minimum speed	45
	n3HI		100%		Maximum speed	45
OTDIS >					Thermal disinfection option	57
	PDIS		01:00		Monitoring period (interval)	57
	DDIS		01:00		Disinfection period	57
	TDIS		60 °C		Disinfection temperature	57
	SDIS		00:00		Starting time	57
	TSDIS		3		Temperature sensor for disinfection	58
	OTDIS		ON		Deactivation Thermal disinfection	58
OPARR >					Parallel relay option	58
	PARRE		2		Parallel relay	58
	INVER		OFF		Inversion	58
OHQM >					Heat quantity measurement option	58
	FTYPE		1		Flow rate detection type	58
	FMAX		6 l/min		Adjustable maximum flow rate	59
	FIMP		1 l/Imp		Pulse rate	59
	MEDT		1		Antifreeze type	59
	MED%		40		Antifreeze concentration	59
	SFHQM		1		Sensor flow HQM	59
	SRHQM		4		Sensor return HQM	59
DATE>					Enter date	60
	TIME		12:00		Time	60
	YYYY		2010		Year	60
	MM		03		Month	60
	DD		15		Day	60
LANG >			dE		Language	61
MAN >			Auto		Manual mode	56
BLPR >			OFF		Blocking protection	43
UNIT >			°C		Unit	60
OSDC >					SD card option	61
CODE			0000		User code	64
RESET			OFF		Factory setting	

* are blocked against each other

7 User code and short menu - Adjustment values

CODE

The access to some adjustment values can be restricted via a user code (customer). For safety reasons, the user code should generally be set to the customer code before the controller is handed to the customer!

1. Expert **0262** (Factory setting)

All menus and adjustment values are shown and all values can be altered.

2. Customer **0000**

The expert level is not shown, adjustment values can

be changed partly (see below)

➔ In order to restrict the access, enter 0000 in the menu item **CODE**.

The display changes to the status level. If the adjustment channel is selected afterwards, the short menu shown below will be available. The short menu suits the selected system.

➔ In order to authorise the access, enter 0262 in the menu item **CODE**.

Channel	Factory setting	Adjustment range	Designation
TIME	12:00	00:00 ... 23:59	Time
DT1O	6	1.0 ... 50.0 K	Switch-on temperature difference store
DT1F	4	0.5 ... 49.5 K	Switch-off temperature difference store
DT1S	10	1.0 ... 50.0 K	Set temperature difference store
S1MAX	60	4 ... 95 °C	Store maximum limitation
DT2O	6	1.0 ... 50.0 K	Switch-on temperature difference store 1
DT2F	4	0.5 ... 49.5 K	Switch-off temperature difference store 1
DT2S	10	1.0 ... 50.0 K	Set temperature difference store 1
S2MAX	60	4 ... 95 °C	Store maximum limitation store 1
LST2	On	On/OFF	Loading store 2 on
DT3O	6	1.0 ... 50.0 K	Switch-on temperature difference store 2
DT3F	4	0.5 ... 49.5 K	Switch-off temperature difference store 2
DT3S	10	1.5 ... 50.0 K	Set temperature difference store 2
S3MAX	60	4 ... 95 °C	Store maximum limitation store 2
LST3	On	On/OFF	Loading store 3 on
MAN1	Auto	Auto/ON/OFF/n LO/n HI	Manual operation pump 1
MAN2	Auto	Auto/ON/OFF/n LO/n HI	Manual operation pump 2
MAN3	Auto	Auto/ON/OFF/n LO/n HI	Manual operation pump 3
MAN4	Auto	Auto/On/OFF	Manual operation pump 4
CODE	0000	0000/0262	User code

8 Messages

In the case of an error, the directional pad flashes red and a message is indicated in the status display. A warning triangle is additionally indicated. If more than one error or fault condition has occurred, only the one with the highest priority will be displayed as a message in the status display.

In the case of a sensor error, the corresponding relay is switched off, and a message appears on the display marked by an E. Additionally, a corresponding value for the error type assumed is indicated.

After the error has been removed, the error message disappears.

Error message	Value	Description	Solution
ES1 ... 5	-88.8	Short circuit at sensor 1...7	Check the cable
	888.8	Broken cable at sensor 1 ... 7	
PARAM		Remote parametrisation	Do not parametrise the controller via the push buttons during remote parametrisation

9 Troubleshooting

If a malfunction occurs, a message will appear on the display of the controller.

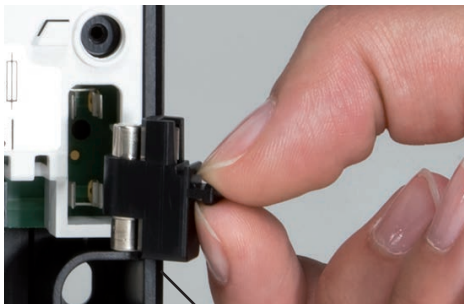

fuse



WARNING! Electric shock!



Upon opening the housing, live parts are exposed!

→ **Always disconnect the controller from power supply before opening the housing!**

The controller is protected by a fuse. The fuse holder (which also holds the spare fuse) becomes accessible when the cover is removed. To replace the fuse, pull the fuse holder from the base.

Directional pad flashes red. The symbol  is indicated on the display and the symbol  flashes.

Sensor fault. An error code instead of a temperature is shown on the sensor display channel.

888.8

Cable is broken.
Check the cable.

- 88.8

Short circuit.
Check the cable.

Disconnected Pt1000 temperature sensors can be checked with an ohmmeter. Please check the resistance values correspond with the table.

°C	Ω	°C	Ω
-10	961	55	1213
-5	980	60	1232
0	1000	65	1252
5	1019	70	1271
10	1039	75	1290
15	1058	80	1309
20	1078	85	1328
25	1097	90	1347
30	1117	95	1366
35	1136	100	1385
40	1155	105	1404
45	1175	110	1423
50	1194	115	1442

resistance values of
PT1000-sensors

The directional pad is permanently off.

Check the power supply of the controller. Is it disconnected?

no

The fuse of the controller could be blown. The fuse holder (which holds the spare fuse) becomes accessible when the cover is removed. The fuse can then be replaced.

yes

Check the supply line and reconnect it.

9.1 Miscellaneous

Pump is overheated, but no heat transfer from the collector to the store, flow and return have the same temperature; perhaps also bubbling in the lines.

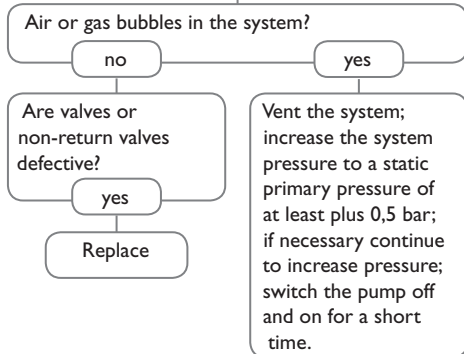

Pump starts up very late.

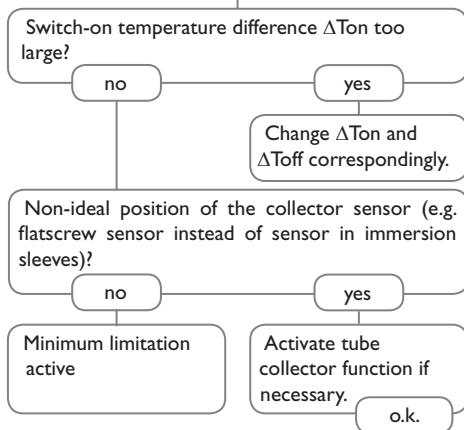

Pump starts for a short moment, switches off, switches on again, etc.

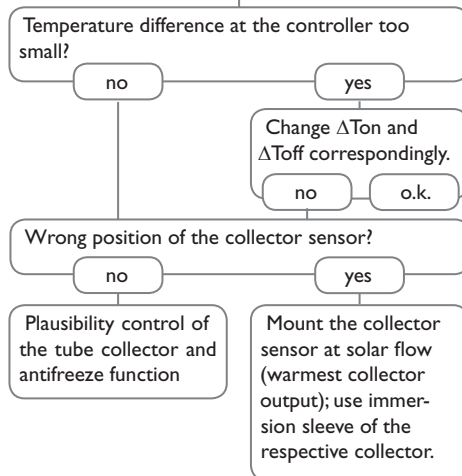

The temperature difference between store and collector increases enormously during operation; the collector circuit cannot dissipate the heat.

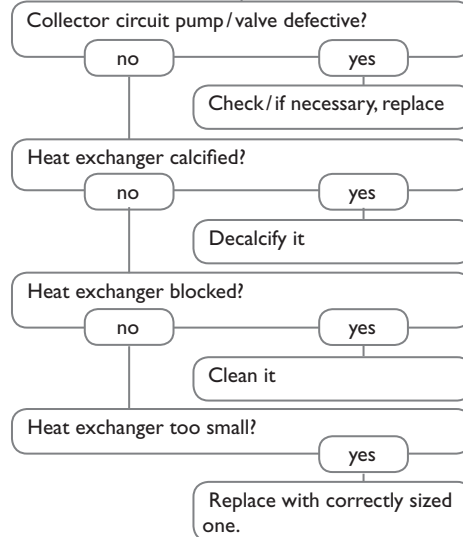

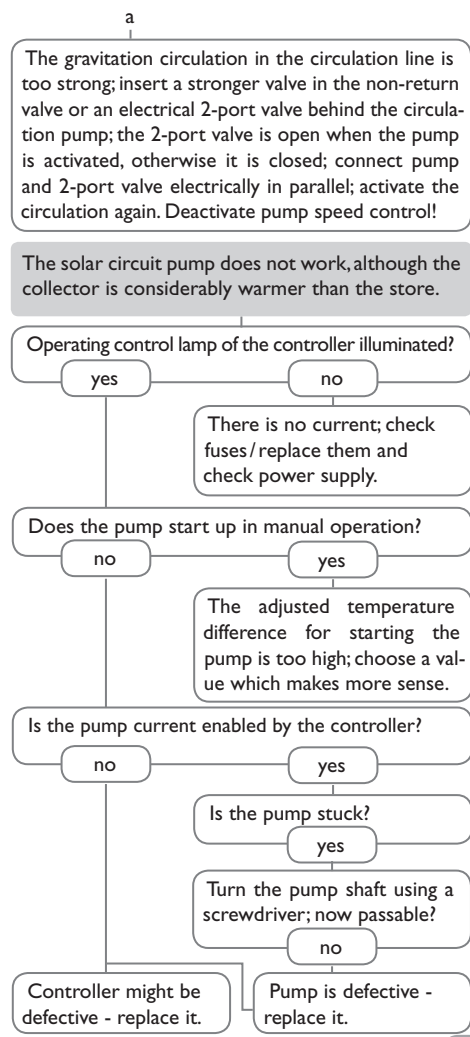
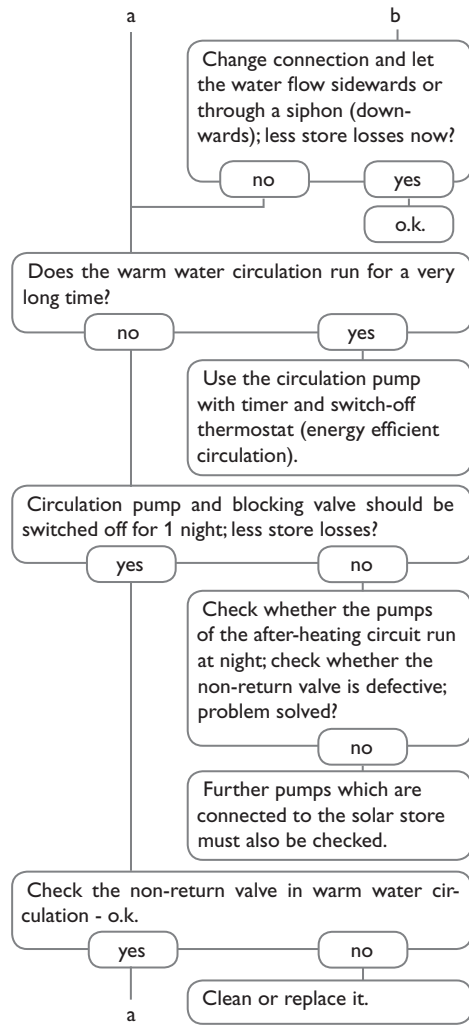
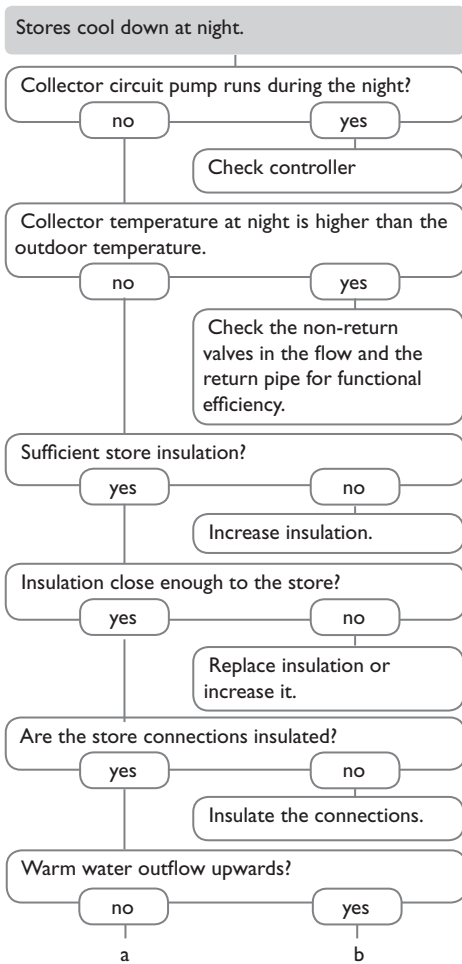

10 Accessories

10.1 Sensors and measuring instruments



Temperature sensors

The product range includes high-precision platinum temperature sensors, flatscrew sensors, outdoor temperature sensors, indoor temperature sensors, cylindrical clip-on sensors, also as complete sensors with immersion sleeve.



Overvoltage protection device

In order to avoid overvoltage damage at collector sensors (e.g. caused by local lightning storms), we recommend installing the overvoltage protection RESOL SP10.

RESOL SP10

Article no.: **180 110 70**



V40 flowmeter

The RESOL V40 is a measuring instrument for detecting the flow of water or water/glycol mixtures. After a specific volume has passed, the V40 reed switch sends an impulse to the calorimeter. The heat quantity used is calculated by the calorimeter using these impulses and the measured temperature difference with the help of pre-defined parameters (glycol type, concentration, heat capacity, etc.).

RESOL V40

Article no.: **280 011 00**

10.2 Interface adapters



Interface adapters

VBus®/USB and VBus®/LAN

The new VBus®/USB interface adapter is the interface between the controller and a personal computer. With its standard mini-USB port it enables a fast transmission of system data for processing, visualising and archiving as well as the parametrisation of the controller via the VBus®. A full version of the RESOL ServiceCenter software is included.

The VBus®/LAN interface adapter is designed for the direct connection of the controller to a PC or router. It enables easy access to the controller via the local network of the owner. Thus, controller access, system parametrisation and data charting can be effected from every workstation of the network. The VBus®/LAN interface adapter is suitable for all controllers equipped with a RESOL VBus®. A full version of the RESOL ServiceCenter software is included.

RESOL VBus®/USB

Article no.: **180 008 50**

RESOL VBus®/LAN

Article no.: **180 008 80**



Smart Display SD3 / Large Display GA3

The RESOL Smart Display is designed for simple connection to RESOL controllers with RESOL VBus®. It is used for visualising data issued by the controller: collector temperature, store temperature and energy yield of the solar system. The use of high-efficiency LEDs and filter glass assures a high optical brilliance and good readability even in poor visibility conditions and from a larger distance. An additional power supply is not required. One module is required per controller.

The RESOL GA3 is a completely mounted large display module for visualisation of collector- and store temperatures as well as the heat quantity yield of the solar system via one 6-digit and two 4-digit 7-segment-displays. An easy connection to all controllers with RESOL VBus® is possible. The front plate is made of antireflective filterglass and is printed with a light-resistant UV-lacquering. The universal RESOL VBus® allows the parallel connection of 8 large displays as well as additional VBus® modules.

RESOL SD3

Article no.: **180 004 93**

RESOL GA3

Article no.: **180 006 53**



AM1 Alarm module

The AM1 Alarm module is designed to signal system failures. It is to be connected to the VBus® of the controller and issues an optical signal via the red LED if a failure has occurred. The AM1 also has a potential-free relay output, which can e. g. be connected to a building management system (BMS). Thus, a collective error message can be issued in the case of a system failure. Depending on the controller and the sensors connected, different fault conditions can be signalled, e. g. sensor failures, excess or negative system pressure as well as errors in the flow rate, such as a dry run of the pump.

The AM1 Alarm module ensures that occurring failures can be immediately recognised and repaired, even if the system and the controller are difficult to access or located in a remote place. Thus, the reliability and the stable yield of the system are ensured.

RESOL AM1

Article no.: **180 008 70**

11 Index

A

Antifreeze function 47

B

Blocking protection time, display channel 43

C

Collector cooling 46

Collector emergency shutdown 46

Collector temperatures, display channel 41

Cooling functions 51

D

ΔT control 43

Disinfection period, display channel 43

F

Flow rate, display channel 41

Further temperatures, display channel 41

H

Heat dump 52

Heat exchange function / solid fuel boiler / return preheating 52

Heat quantity, display channel 42

Heat quantity measurement 58

HQM sensors 59

L

Language 61

Loading store 2 45

M

Manual mode 56

Maximum speed 45

Maximum store temperature 44

Maximum temperature limitation 53, 54

Minimum collector limitation 46

Minimum speed 45

Minimum temperature limitation 53, 54

Monitoring period, display channel 42

O

Operating hours counter 42

P

Parallel relay 58

Pause control 51

Priority logic 48

Pump control 45

S

SD card 61

Selecting the system 43

Sensor maximum store temperature 44

Speed 42

Speed control 44

Spreaded loading option 50

Starting time, display channel 42

Store cooling 52

Store set option 50

Store temperatures, display channel 41

System cooling 51

T

Temperatures at S3, S4 and S5, display channel 41

Thermal disinfection (OTDIS) 57

Thermal disinfection with starting delay 57

Thermostat function 55

Time and date 60

Time, display channel 43

Tube collector function 46

Distributed by:

RESOL – Elektronische Regelungen GmbH

Heiskampstraße 10
45527 Hattingen / Germany
Tel.: +49 (0) 23 24 / 96 48 - 0
Fax: +49 (0) 23 24 / 96 48 - 755
www.resol.com
info@resol.com

Important note

The texts and drawings in this manual are correct to the best of our knowledge. As faults can never be excluded, please note:

Your own calculations and plans, under consideration of the current standards and directions should only be basis for your projects. We do not offer a guarantee for the completeness of the drawings and texts of this manual - they only represent some examples. They can only be used at your own risk. No liability is assumed for incorrect, incomplete or false information and / or the resulting damages.

Note

The design and the specifications can be changed without notice.
The illustrations may differ from the original product.

Imprint

This mounting- and operation manual including all parts is copyrighted. Another use outside the copyright requires the approval of RESOL – Elektronische Regelungen GmbH. This especially applies for copies, translations, micro films and the storage into electronic systems.

© RESOL – Elektronische Regelungen GmbH